

2005 Edition



Quick Reference Guide

Cross Reference Guide





Premium Alternator 35SI HP™

**PREMIUM BRUSHLESS
HEAT RESISTANT ALTERNATOR**

35SI HP™



New Service #8600064
Reman #8700016



New Service #8600065
Reman #8700017



New Service #8600066
Reman #8700018

Warranty

New service: 3 years - 350,000 miles

Reman: 2 years - 250,000 miles

Premium Brushless design

Extends life

Optimizes performance

140 amps of power

Heat Resistant

Strategically placed radiant vents

Performance Tested to 105C

Remote Sense Technology

Optimizes battery state of charge

*Core acceptance for same mounting style
3351 or 3451 brushless unit.*



Systems Analyzer Intelli-Check2

ALL-IN-ONE, HAND-HELD TESTER

ACCURATELY TESTS:
ALTERNATOR – BATTERY – CABLE VOLTAGE DROP

FEATURES:

- Lightweight, Hand-held For Easy Portable Testing
- Tests Heavy Duty 12-volt Batteries
- Tests Alternator
- Tests Cable Voltage Drop
- Stores Up To 200 Tests In Memory
- Rs232 Port For Optional PC Adapter
- Optional AC-22 Infrared Printer With Carrying Case
- Complete electrical systems test
- Test 12V + 24V systems
- J1708 cable



Remy Part No.	Description
10503560	Tester, Printer, Case,
10512657	Tester Only
10503176	Printer Only
10512658	Case Only
10503558	PC Adapter
10503559	45' Lead Kit (Bus & Coach)

Alternator Tester Accurately Tests	Battery Tester Accurately Tests	Cable Voltage Drop Tester Accurately Tests
Overcharge	Good Battery	Starter Circuit
Undercharge	Bad Battery	Alternator Circuit
Partial Charge	Marginal Battery	Control/Mag
Diode/Stator	Bad Cell	Switch Circuit
Phase Failure	in Battery	Test Cables to TMC Specs.
Microprocessor Controlled!	Electronic Load Test	Common Source for Electrical System Problems





We've got you Covered!

Delco Remy Heavy Duty Starters

New Service Alternators & Starters
Genuine Delco Remy Remanufactured Units
New Service Parts



Road Gang® Premium Electrical Systems

Road Gang® Batteries

System Matched Components
and Full Line Battery Coverage:
Truck Marine, Bus & Industrial



Light Duty Automotive Units

Full Line Domestic and
Import New and
Remanufactured Units



Electrical & Test Equipment

Intelli-Check2™
Bench-Top Tester
Voltage Tester



Power Inverters

From 150 watts to 1750 watts
We've got the power you need.

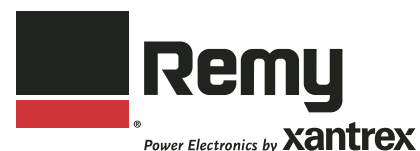



Remanufactured Not Rebuilt!

Why Take Chances?

**TRUST THE BRAND THAT'S KEPT MORE TRUCKS
RUNNING LONGER THAN ANY OTHER BRAND
ON THE ROAD!**



Our remanufacturing process uses the same parts and processes, including final testing, that goes into our new products.

And, since we're the world's leading manufacturer of heavy duty alternators & starters, we know what we're doing!

Always Go with Genuine – DELCO REMY!



2005 PART NUMBER QUICK REFERENCE GUIDE

Remanufactured Alternators

Remanufactured Starters

Popular New Service Alternators

Popular New Service Starters

Miscellaneous

Interchange

10SI

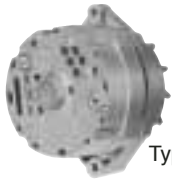

Type 100

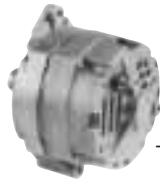

Type 116



Type 136

Remanufactured Alternators

Part Number	Reman Number	Type	Volts	Battery Term	R Term	I Term	Amps
-------------	--------------	------	-------	--------------	--------	--------	------

DELCO REMY REMANUFACTURED PART NUMBERS

10459343	10459343	100	24	M6	PIN	-	40
10459344	10459344	116	12	M6	BLADE	-	78
10459351	10459351	136	12	M6	BLADE	-	72
10459365	10459365	116	12	M6	BLADE	-	42
10459526	10459526	116	12	M6	BLADE	-	105
19020500	19020500	116	12	M6	-	-	72
19020501	19020501	100	12	M6	-	-	63
19020516	19020516	136	12	M6	-	-	61
19020521	19020521	116	12	M6	BLADE	-	63
19020525	19020525	136	24	M6	BLADE	-	40
19020526	19020526	116	24	M6	BLADE	-	40
19020527	19020527	116	24	M6	BLADE	-	40

DELCO REMY O.E. PART NUMBERS

1100110	19020501	100	12	M6	-	-	63
1100111	19020501	100	12	M6	-	-	63
1100113	19020501	100	12	M6	-	-	63
1100115	19020501	100	12	M6	-	-	63
1100121	19020501	100	12	M6	-	-	63
1100122	19020501	100	12	M6	-	-	63
1100124	19020501	100	12	M6	-	-	63
1100125	19020501	100	12	M6	-	-	63
1100127	19020501	100	12	M6	-	-	63
1100129	19020501	100	12	M6	-	-	63
1100130	19020501	100	12	M6	-	-	63
1100131	19020501	100	12	M6	-	-	63
1100132	19020501	100	12	M6	-	-	63
1100133	19020501	100	12	M6	-	-	63
1100140	19020501	100	12	M6	-	-	63
1100141	19020501	100	12	M6	-	-	63
1100142	19020501	100	12	M6	-	-	63
1100143	19020501	100	12	M6	-	-	63
1100145	19020501	100	12	M6	-	-	63
1100146	19020501	100	12	M6	-	-	63
1100148	19020501	100	12	M6	-	-	63
1100149	19020501	100	12	M6	-	-	63
1100150	19020501	100	12	M6	-	-	63
1100151	19020501	100	12	M6	-	-	63
1100152	19020501	100	12	M6	-	-	63
1100153	19020501	100	12	M6	-	-	63
1100154	19020501	100	12	M6	-	-	63
1100155	19020501	100	12	M6	-	-	63
1100156	19020501	100	12	M6	-	-	63
1100158	19020501	100	12	M6	-	-	63
1100159	19020501	100	12	M6	-	-	63
1100162	19020501	100	12	M6	-	-	63
1100163	19020501	100	12	M6	-	-	63
1100164	19020501	100	12	M6	-	-	63
1100166	19020501	100	12	M6	-	-	63

Part Number	Reman Number	Type	Volts	Battery Term	R Term	I Term	Amps
-------------	--------------	------	-------	--------------	--------	--------	------

DELCO REMY O.E. PART NUMBERS (CONT.)

1100167	19020501	100	12	M6	-	-	63
1100168	19020501	100	12	M6	-	-	63
1100170	19020501	100	12	M6	-	-	63
1100171	19020500	116	12	M6	-	-	72
1100174	19020501	100	12	M6	-	-	63
1100175	19020501	100	12	M6	-	-	63
1100176	19020501	100	12	M6	-	-	63
1100179	19020501	100	12	M6	-	-	63
1100199	19020501	100	12	M6	-	-	63
1100201	19020501	100	12	M6	-	-	63
1100202	19020501	100	12	M6	-	-	63
1100203	19020501	100	12	M6	-	-	63
1100204	19020501	100	12	M6	-	-	63
1100218	19020501	100	12	M6	-	-	63
1100221	19020501	100	12	M6	-	-	63
1100222	19020501	100	12	M6	-	-	63
1100225	19020501	100	12	M6	-	-	63
1100226	19020501	100	12	M6	-	-	63
1100227	19020501	100	12	M6	-	-	63
1100228	19020501	100	12	M6	-	-	63
1100229	19020501	100	12	M6	-	-	63
1100230	19020501	100	12	M6	-	-	63
1100231	19020501	100	12	M6	-	-	63
1100232	19020501	100	12	M6	-	-	63
1100233	19020501	100	12	M6	-	-	63
1100235	19020501	100	12	M6	-	-	63
1100236	19020501	100	12	M6	-	-	63
1100268	19020501	100	12	M6	-	-	63
1100487	19020501	100	12	M6	-	-	63
1100490	19020500	116	12	M6	-	-	72
1100491	19020501	100	12	M6	-	-	63
1100493	19020501	100	12	M6	-	-	63
1100494	19020501	100	12	M6	-	-	63
1100542	19020501	100	12	M6	-	-	63
1100543	19020501	100	12	M6	-	-	63
1100544	19020501	100	12	M6	-	-	63
1100545	19020501	100	12	M6	-	-	63
1100546	19020501	100	12	M6	-	-	63
1100547	19020501	100	12	M6	-	-	63
1100548	19020501	100	12	M6	-	-	63
1100549	19020501	100	12	M6	-	-	63
1100552	19020501	100	12	M6	-	-	63
1100554	19020501	100	12	M6	-	-	63
1100560	19020501	100	12	M6	-	-	63
1100573	19020501	100	12	M6	-	-	63
1100574	19020501	100	12	M6	-	-	63
1100575	19020501	100	12	M6	-	-	63
1100578	19020501	100	12	M6	-	-	63
1100579	19020501	100	12	M6	-	-	63

REMANUFACTURED ALTERNATORS



10SI (cont.)

Part Number	Reman Number	Type	Volts	Battery Term	R Term	I Term	Amps	Part Number	Reman Number	Type	Volts	Battery Term	R Term	I Term	Amps
DELCO REMY O.E. PART NUMBERS (CONT.)								DELCO REMY O.E. PART NUMBERS (CONT.)							
1100580	19020501	100	12	M6	-	-	63	1101195	19020527	116	24	M6	BLADE	-	40
1100581	19020501	100	12	M6	-	-	63	1101204	19020527	116	24	M6	BLADE	-	40
1100582	19020501	100	12	M6	-	-	63	1101285	10459343	100	24	M6	PIN	-	40
1100583	19020501	100	12	M6	-	-	63	1102346	19020501	100	12	M6	-	-	63
1100584	19020500	116	12	M6	-	-	72	1102349	19020500	100	12	M6	-	-	63
1100585	19020500	116	12	M6	-	-	72	1102359	19020500	100	24	M6	PIN	-	40
1100587	19020500	116	12	M6	-	-	72	1102361	19020500	100	24	M6	PIN	-	40
1100588	19020501	100	12	M6	-	-	63	1102362	19020500	100	24	M6	PIN	-	40
1100589	19020501	100	12	M6	-	-	63	1102363	19020500	100	24	M6	PIN	-	40
1100592	19020501	100	12	M6	-	-	63	1102375	19020500	100	12	M6	-	-	63
1100593	19020501	100	12	M6	-	-	63	1102380	19020501	100	12	M6	-	-	63
1100597	19020501	100	12	M6	-	-	63	1102391	19020501	100	12	M6	-	-	63
1100800	19020501	100	12	M6	-	-	63	1102392	19020501	100	12	M6	-	-	63
1100801	19020501	100	12	M6	-	-	63	1102460	19020501	100	12	M6	-	-	63
1100809	19020501	100	12	M6	-	-	63	1102461	19020501	100	12	M6	-	-	63
1100825	19020501	100	12	M6	-	-	63	1102468	19020501	100	12	M6	-	-	63
1100830	19020501	100	12	M6	-	-	63	1102474	19020501	100	12	M6	-	-	63
1100832	19020501	100	12	M6	-	-	63	1102485	19020501	100	12	M6	-	-	63
1100833	19020501	100	12	M6	-	-	63	1102847	19020501	100	12	M6	-	-	63
1100852	19020501	100	12	M6	-	-	63	1102848	19020501	100	12	M6	-	-	63
1100853	19020501	100	12	M6	-	-	63	1102849	19020501	100	12	M6	-	-	63
1100854	19020501	100	12	M6	-	-	63	1102852	19020501	100	12	M6	-	-	63
1100855	19020501	100	12	M6	-	-	63	1102860	19020501	100	12	M6	-	-	63
1100859	19020501	100	12	M6	-	-	63	1102866	19020500	116	12	M6	-	-	72
1100880	19020501	100	12	M6	-	-	63	1102867	19020500	116	12	M6	-	-	72
1100881	19020501	100	12	M6	-	-	63	1102876	19020500	116	12	M6	-	-	72
1100882	19020501	100	12	M6	-	-	63	1102877	19020501	100	12	M6	-	-	63
1100884	19020501	100	12	M6	-	-	63	1102878	19020501	100	12	M6	-	-	63
1100890	19020501	100	12	M6	-	-	63	1102879	19020501	100	12	M6	-	-	63
1100897	19020501	100	12	M6	-	-	63	1102881	19020501	100	12	M6	-	-	63
1100899	19020501	100	12	M6	-	-	63	1102882	19020501	100	12	M6	-	-	63
1100900	19020501	100	12	M6	-	-	63	1102883	19020501	100	12	M6	-	-	63
1100901	19020501	100	12	M6	-	-	63	1102884	19020501	100	12	M6	-	-	63
1100902	19020501	100	12	M6	-	-	63	1102885	19020501	100	12	M6	-	-	63
1100903	19020501	100	12	M6	-	-	63	1102886	19020501	100	12	M6	-	-	63
1100904	19020501	100	12	M6	-	-	63	1102887	19020501	100	12	M6	-	-	63
1100920	19020501	100	12	M6	-	-	63	1102888	19020501	100	12	M6	-	-	63
1100922	19020501	100	12	M6	-	-	63	1102889	19020501	100	12	M6	-	-	63
1100923	19020501	100	12	M6	-	-	63	1102891	19020501	100	12	M6	-	-	63
1100924	19020501	100	12	M6	-	-	63	1102892	19020501	100	12	M6	-	-	63
1100925	19020501	100	12	M6	-	-	63	1102893	19020501	100	12	M6	-	-	63
1100926	19020501	100	12	M6	-	-	63	1102894	19020501	100	12	M6	-	-	63
1100927	19020501	100	12	M6	-	-	63	1102896	19020500	116	12	M6	-	-	72
1100928	19020501	100	12	M6	-	-	63	1102898	19020501	100	12	M6	-	-	63
1100930	19020501	100	12	M6	-	-	63	1102902	19020501	100	12	M6	-	-	63
1100934	19020501	100	12	M6	-	-	63	1102903	19020501	100	12	M6	-	-	63
1100935	19020501	100	12	M6	-	-	63	1102904	19020501	100	12	M6	-	-	63
1100936	19020501	100	12	M6	-	-	63	1102908	19020501	100	12	M6	-	-	63
1100937	19020501	100	12	M6	-	-	63	1102909	19020501	100	12	M6	-	-	63
1100940	19020501	100	12	M6	-	-	63	1102914	19020500	116	12	M6	-	-	72
1100946	19020501	100	12	M6	-	-	63	1102915	19020501	100	12	M6	-	-	63
1100947	19020501	100	12	M6	-	-	63	1102918	19020527	116	24	M6	BLADE	-	40
1100948	19020501	100	12	M6	-	-	63	1102922	19020500	116	12	M6	-	-	72
1100949	19020501	100	12	M6	-	-	63	1102925	19020521	116	12	M6	BLADE	-	63
1100950	19020501	100	12	M6	-	-	63	1102926	19020521	116	12	M6	BLADE	-	63
1101155	19020501	100	12	M6	-	-	63	1102927	19020521	116	12	M6	BLADE	-	63

10SI (cont.)

Remanufactured Alternators

Part Number	Reman Number	Type	Volts	Battery Term	R Term	I Term	Amps
DELCO REMY O.E. PART NUMBERS (CONT.)							
1102928	19020521	116	12	M6	BLADE	-	63
1102929	19020521	116	12	M6	BLADE	-	63
1102930	19020500	116	12	M6	-	-	72
1102932	19020500	116	12	M6	-	-	72
1102936	19020521	116	12	M6	BLADE	-	63
1102937	19020500	116	12	M6	-	-	72
1102940	19020521	116	12	M6	BLADE	-	63
1102941	19020501	100	12	M6	-	-	63
1103033	19020501	100	12	M6	-	-	63
1103034	19020501	100	12	M6	-	-	63
1103035	19020500	116	12	M6	-	-	72
1103036	19020501	100	12	M6	-	-	63
1103037	19020501	100	12	M6	-	-	63
1103044	19020501	100	12	M6	-	-	63
1103045	19020501	100	12	M6	-	-	63
1103047	19020501	100	12	M6	-	-	63
1103054	19020521	116	12	M6	BLADE	-	63
1103055	19020501	100	12	M6	-	-	63
1103057	19020501	100	12	M6	-	-	63
1103058	19020501	100	12	M6	-	-	63
1103060	19020501	100	12	M6	-	-	63
1103061	19020501	100	12	M6	-	-	63
1103063	19020501	100	12	M6	-	-	63
1103064	19020501	100	12	M6	-	-	63
1103065	19020501	100	12	M6	-	-	63
1103066	19020501	100	12	M6	-	-	63
1103067	19020501	100	12	M6	-	-	63
1103068	19020501	100	12	M6	-	-	63
1103069	19020501	100	12	M6	-	-	63
1103070	19020501	100	12	M6	-	-	63
1103075	19020501	100	12	M6	-	-	63
1103076	19020501	100	12	M6	-	-	63
1103079	19020501	100	12	M6	-	-	63
1103082	19020501	100	12	M6	-	-	63
1103084	19020501	100	12	M6	-	-	63
1103085	19020501	100	12	M6	-	-	63
1103086	19020501	100	12	M6	-	-	63
1103088	19020501	100	12	M6	-	-	63
1103089	19020501	100	12	M6	-	-	63
1103090	19020501	100	12	M6	-	-	63
1103091	19020501	100	12	M6	-	-	63
1103092	19020501	100	12	M6	-	-	63
1103093	19020501	100	12	M6	-	-	63
1103094	19020501	100	12	M6	-	-	63
1103095	19020501	100	12	M6	-	-	63
1103096	19020501	100	12	M6	-	-	63
1103097	19020501	100	12	M6	-	-	63
1103100	19020501	100	12	M6	-	-	63
1103101	19020501	100	12	M6	-	-	63
1103102	19020501	100	12	M6	-	-	63
1103103	19020501	100	12	M6	-	-	63
1103104	19020501	100	12	M6	-	-	63
1103105	19020501	100	12	M6	-	-	63
1103106	19020501	100	12	M6	-	-	63
1103116	19020521	116	12	M6	BLADE	-	63
1103118	19020501	100	12	M6	-	-	63

Part Number	Reman Number	Type	Volts	Battery Term	R Term	I Term	Amps
DELCO REMY O.E. PART NUMBERS (CONT.)							
1103122	19020501	100	12	M6	-	-	63
1103123	19020527	116	24	M6	BLADE	-	40
1103124	19020500	116	12	M6	-	-	72
1103125	19020521	116	12	M6	BLADE	-	63
1103126	19020521	116	12	M6	BLADE	-	63
1103127	19020500	116	12	M6	-	-	72
1103128	19020500	116	12	M6	-	-	72
1103130	19020521	116	12	M6	BLADE	-	63
1103131	19020521	116	12	M6	BLADE	-	63
1103133	19020521	116	12	M6	BLADE	-	63
1103135	19020521	116	12	M6	BLADE	-	63
1103138	19020521	116	12	M6	BLADE	-	63
1103140	19020501	100	12	M6	-	-	63
1103141	19020500	116	12	M6	-	-	72
1103143	19020501	100	12	M6	-	-	63
1103144	19020501	100	12	M6	-	-	63
1103145	19020501	100	12	M6	-	-	63
1103146	19020501	100	12	M6	-	-	63
1103147	19020501	100	12	M6	-	-	63
1103148	19020501	100	12	M6	-	-	63
1103149	19020501	100	12	M6	-	-	63
1103151	19020501	100	12	M6	-	-	63
1103152	19020501	100	12	M6	-	-	63
1103153	19020501	100	12	M6	-	-	63
1103154	19020501	100	12	M6	-	-	63
1103155	19020501	100	12	M6	-	-	63
1103156	19020501	100	12	M6	-	-	63
1103157	19020501	100	12	M6	-	-	63
1103158	19020501	100	12	M6	-	-	63
1103159	19020500	116	12	M6	-	-	72
1103160	19020500	116	12	M6	-	-	72
1103165	19020500	116	12	M6	-	-	72
1103166	19020500	116	12	M6	-	-	72
1103169	10459344	116	12	M6	BLADE	-	78
1103171	19020521	116	12	M6	BLADE	-	63
1103172	19020521	116	12	M6	BLADE	-	63
1103173	19020500	116	12	M6	-	-	72
1103174	19020521	116	12	M6	BLADE	-	63
1103175	19020521	116	12	M6	BLADE	-	63
1103182	10459344	116	12	M6	BLADE	-	78
1103183	19020521	116	12	M6	BLADE	-	63
1103184	19020500	116	12	M6	-	-	72
1103186	10459344	116	12	M6	BLADE	-	78
1103188	19020501	100	12	M6	-	-	63
1103196	19020501	100	12	M6	-	-	63
1103197	19020501	100	12	M6	-	-	63
1105043	10459344	116	12	M6	BLADE	-	78
1105050	10459344	116	12	M6	BLADE	-	78
1105066	19020521	116	12	M6	BLADE	-	63
1105067	19020501	100	12	M6	-	-	63
1105068	19020500	116	12	M6	-	-	72
1105069	19020500	116	12	M6	-	-	72
1105070	19020521	116	12	M6	BLADE	-	63
1105072	19020521	116	12	M6	BLADE	-	63
1105073	19020500	116	12	M6	-	-	72
1105074	19020521	116	12	M6	BLADE	-	63

REMANUFACTURED ALTERNATORS



10SI (cont.)

Part Number	Reman Number	Type	Volts	Battery Term	R Term	I Term	Amps
DELCO REMY O.E. PART NUMBERS							
1105079	19020501	100	12	M6	-	-	63
1105080	19020501	100	12	M6	-	-	63
1105098	19020500	116	12	M6	-	-	72
1105160	19020521	116	12	M6	BLADE	-	63
1105161	19020500	116	12	M6	-	-	72
1105162	19020521	116	12	M6	BLADE	-	63
1105163	19020521	116	12	M6	BLADE	-	63
1105164	19020521	116	12	M6	BLADE	-	63
1105165	19020521	116	12	M6	BLADE	-	63
1105166	19020521	116	12	M6	BLADE	-	63
1105167	19020521	116	12	M6	BLADE	-	63
1105168	19020521	116	12	M6	BLADE	-	63
1105169	19020521	116	12	M6	BLADE	-	63
1105170	19020521	116	12	M6	BLADE	-	63
1105171	19020521	116	12	M6	BLADE	-	63
1105172	19020500	116	12	M6	-	-	72
1105173	19020500	116	12	M6	-	-	72
1105174	19020500	116	12	M6	-	-	72
1105175	19020500	116	12	M6	-	-	72
1105176	19020500	116	12	M6	-	-	72
1105177	19020500	116	12	M6	-	-	72
1105178	19020500	116	12	M6	-	-	72
1105179	19020527	116	24	M6	BLADE	-	40
1105351	19020501	100	12	M6	-	-	63
1105360	19020501	100	12	M6	-	-	63
1105363	19020501	100	12	M6	-	-	63
1105419	19020527	116	24	M6	BLADE	-	40
1105420	19020521	116	12	M6	BLADE	-	63
1105421	19020500	116	12	M6	-	-	72
1105422	19020521	116	12	M6	BLADE	-	63
1105423	19020500	116	12	M6	-	-	72
1105424	19020521	116	12	M6	BLADE	-	63
1105429	19020521	116	12	M6	BLADE	-	63
1105431	19020525	136	24	M6	BLADE	-	40
1105434	19020500	116	12	M6	-	-	72
1105436	19020525	136	24	M6	BLADE	-	40
1105456	10459365	116	12	M6	BLADE	-	42
1105459	19020526	116	24	M6	BLADE	-	40
1105510	19020527	116	24	M6	BLADE	-	40
1105514	19020521	116	12	M6	BLADE	-	63
1105558	19020521	116	12	M6	BLADE	-	63
1105559	19020500	116	12	M6	-	-	72
1105573	19020521	116	12	M6	BLADE	-	63
1105574	19020500	116	12	M6	-	-	72
1105584	19020521	116	12	M6	BLADE	-	63
1105586	10459351	136	12	M6	BLADE	-	72
1105619	19020500	116	12	M6	-	-	72
1105645	19020500	116	12	M6	-	-	72
1105649	19020501	100	12	M6	-	-	63
1105686	19020521	116	12	M6	BLADE	-	63
1977421	19020500	116	12	M6	-	-	72
1979872	19020500	116	12	M6	-	-	72
1979873	19020500	116	12	M6	-	-	72
1979875	19020525	136	24	M6	BLADE	-	40
10480058	10459344	116	12	M6	BLADE	-	78

Part Number	Reman Number	Type	Volts	Battery Term	R Term	I Term	Amps
DELCO REMY O.E. PART NUMBERS (CONT.)							
19020531	19020526	116	24	M6	BLADE	-	40
AC DELCO CATALOG NUMBERS							
321-38	19020501	100	12	M6	-	-	63
321-39	19020501	100	12	M6	-	-	63
321-40	19020501	100	12	M6	-	-	63
321-41	19020501	100	12	M6	-	-	63
321-42	19020501	100	12	M6	-	-	63
321-43	19020501	100	12	M6	-	-	63
321-45	19020501	100	12	M6	-	-	63
321-46	19020501	100	12	M6	-	-	63
321-47	19020501	100	12	M6	-	-	63
321-48	19020501	100	12	M6	-	-	63
321-134	19020501	100	12	M6	-	-	63
321-135	19020501	100	12	M6	-	-	63
321-143	19020501	100	12	M6	-	-	63
321-148	19020501	100	12	M6	-	-	63
321-231	19020501	100	12	M6	-	-	63
321-608	19020500	116	12	M6	-	-	72
321-647	19020500	116	12	M6	-	-	72
321-648	19020500	116	12	M6	-	-	72
321-649	19020500	116	12	M6	-	-	72
321-651	10459526	116	12	M6	BLADE	-	105
321-652	19020521	116	12	M6	BLADE	-	63
321-1762	19020500	116	12	M6	-	-	72
321-1768	19020527	116	24	M6	BLADE	-	40
CARGO PART NUMBERS							
110075	10459344	116	12	M6	BLADE	-	78
110233	10459343	100	24	M6	PIN	-	40
110233	10459344	116	12	M6	BLADE	-	78
110233	10459343	100	24	M6	PIN	-	40
110504	10459343	100	24	M6	PIN	-	40
110504	10459365	116	12	M6	BLADE	-	42
110505	10459343	100	24	M6	PIN	-	40
110505	10459344	116	12	M6	BLADE	-	78
110505	10459343	100	24	M6	PIN	-	40
110508	10459344	116	12	M6	BLADE	-	78
CUMMINS RECON PART NUMBERS							
3604475RX	19020500	116	12	M6	-	-	72
3604663RX	19020501	100	12	M6	-	-	63
3604775RX	19020500	116	12	M6	-	-	72
3675100RX	10459351	136	12	M6	BLADE	-	72
3675101RX	19020500	116	12	M6	-	-	72
3604476RX	19020527	116	24	M6	BLADE	-	40
DDC CATALOG NUMBERS							
R0459343	19020501	100	12	M6	-	-	63
R0463648	10459343	100	24	M6	PIN	-	40
R9020500	10459343	100	24	M6	PIN	-	40
DDC PART NUMBERS							
10459345	19020501	100	12	M6	-	-	63
10463648	10459343	100	24	M6	PIN	-	40
19020500	10459343	100	24	M6	PIN	-	40

Remanufactured Alternators

10SI (cont.)

Part Number	Reman Number	Type	Volts	Battery Term	R Term	I Term	Amps
DIXIE PART NUMBERS							
A-142	19020501	100	12	M6	-	-	63
A-184	19020501	100	12	M6	-	-	63
A-1104	19020526	116	24	M6	BLADE	-	40
A-1105	19020500	116	12	M6	-	-	72F
A-1106	19020500	116	12	M6	-	-	72
A-1114	19020525	136	24	M6	BLADE	-	40
A-1115	19020500	116	12	M6	-	-	72
A-1116	19020527	116	24	M6	BLADE	-	40
A-1131	19020501	100	12	M6	-	-	63
A-1132	19020500	116	12	M6	-	-	72
A-1132	19020501	100	12	M6	-	-	63
A-1133	19020501	100	12	M6	-	-	63
A-1137	19020501	100	12	M6	-	-	63
A-1139	19020500	116	12	M6	-	-	72
A-1139	19020501	100	12	M6	-	-	63
A-1339	19020501	100	12	M6	-	-	63
A-1440	10459344	116	12	M6	BLADE	-	78
KOMATSU PART NUMBERS							
ALT1001	10459351	136	12	M6	BLADE	-	72
ALT1002	19020500	116	12	M6	-	-	72
MIDLAND PART NUMBERS							
RA110000X	19020500	116	12	M6	-	-	72
RA110001X	19020525	136	24	M6	BLADE	-	40
RA110010X	19020501	100	12	M6	-	-	63
RA110015X	19020500	116	12	M6	-	-	72
RA110016X	19020500	116	12	M6	-	-	72

Part Number	Reman Number	Type	Volts	Battery Term	R Term	I Term	Amps
WILSON PART NUMBERS							
90-01-3056	19020501	100	12	M6	-	-	63
90-01-3081	19020500	116	12	M6	-	-	72
90-01-3105	19020501	100	12	M6	-	-	63
90-01-3105	19020500	116	12	M6	-	-	72
90-01-3106	19020501	100	12	M6	-	-	63
90-01-3106	19020500	116	12	M6	-	-	72
90-01-3111	19020501	100	12	M6	-	-	63
90-01-3112	19020501	100	12	M6	-	-	63
90-01-3123	19020527	116	24	M6	BLADE	-	40
90-01-3128	19020525	136	24	M6	BLADE	-	40
90-01-3129	19020526	116	24	M6	BLADE	-	40
90-01-3131	19020500	116	12	M6	-	-	72
90-01-3133	19020500	116	12	M6	-	-	72
90-01-3134	19020500	116	12	M6	-	-	72
90-01-3135	19020500	116	12	M6	-	-	72
90-01-3143	19020501	100	12	M6	-	-	63
90-01-3178	19020501	100	12	M6	-	-	63
90-01-4056	19020500	116	12	M6	-	-	72
90-01-4108	19020500	116	12	M6	-	-	72
90-01-4268	10459344	116	12	M6	BLADE	-	78

10SI One Wire Self Exciting

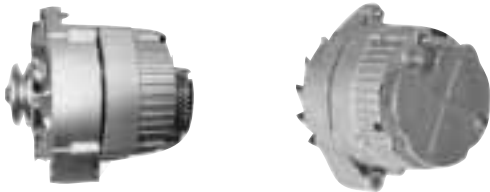

*Note: with chaff shield

Part Number	Reman Number	Type	Volts	Battery Term	R Term	I Term	Amps
DELCO REMY REMANUFACTURED PART NUMBER							
10459509	10459509*	116	12	M6	-	-	63
DELCO REMY O.E. PART NUMBERS							
1100491	10459509*	116	12	M6	-	-	63
1102359	10459509*	116	12	M6	-	-	63
1102363	10459509*	116	12	M6	-	-	63
1102364	10459509*	116	12	M6	-	-	63
1102370	10459509*	116	12	M6	-	-	63

Part Number	Reman Number	Type	Volts	Battery Term	R Term	I Term	Amps
DELCO REMY O.E. PART NUMBERS (CONT.)							
1102924	10459509*	116	12	M6	-	-	63
1102931	10459509*	116	12	M6	-	-	63
1103136	10459509*	116	12	M6	-	-	63
1103137	10459509*	116	12	M6	-	-	63
1105161	10459509*	116	12	M6	-	-	63
1105455	10459509*	116	12	M6	-	-	63
1105456	10459509*	116	12	M6	-	-	63
1105457	10459509*	116	12	M6	-	-	63

REMANUFACTURED ALTERNATORS



12SI



*Note: reverse rotation

Part Number	Reman Number	Battery Volts	Term	R Term	I Term	Amps
DELCO REMY REMANUFACTURED PART NUMBERS						
10459338	10459338	12	M6	PIN	-	94
10459339	10459339*	12	M6	PIN	-	94
10459348	10459348	12	M6	PIN	-	66
10459350	10459350	12	M6	PIN	-	78
19020505	19020505	12	M6	-	-	78
19020528	19020528	12	M6	-	-	94
19020529	19020529	12	M6	-	-	94
DELCO REMY O.E. PART NUMBERS						
1101228	10459348	12	M6	PIN	-	66
1101268	10459350	12	M6	PIN	-	78
1101305	10459339*	12	M6	PIN	-	94
1101307	19020505	12	M6	-	-	78
1101308	19020528	12	M6	-	-	94
1101324	10459339*	12	M6	PIN	-	94
1101345	10459350	12	M6	PIN	-	78
1101484	19020529	12	M6	-	-	94
1105025	10459339*	12	M6	PIN	-	94
1105027	10459339*	12	M6	PIN	-	94
1105028	10459339*	12	M6	PIN	-	94
1105032	10459350	12	M6	PIN	-	78
1105041	10459339*	12	M6	PIN	-	94
1105042	10459339*	12	M6	PIN	-	94
1105369	10459339*	12	M6	PIN	-	94
1105370	10459350	12	M6	PIN	-	78
1105402	10459338	12	M6	PIN	-	94

Part Number	Reman Number	Battery Volts	Term	R Term	I Term	Amps
DELCO REMY O.E. PART NUMBERS (CONT.)						
1105428	10459338	12	M6	PIN	-	94
1105480	10459339*	12	M6	PIN	-	94
1105493	10459339*	12	M6	PIN	-	94
1105516	10459350	12	M6	PIN	-	78
1105517	10459350	12	M6	PIN	-	78
1105561	10459339*	12	M6	PIN	-	94
1105562	10459339*	12	M6	PIN	-	94
1105564	10459339*	12	M6	PIN	-	94
10479850	10459350	12	M6	PIN	-	78
AC DELCO CATALOG NUMBERS						
321-357	19020505	12	M6	-	-	78
321-1015	19020528	12	M6	-	-	94
321-1764	19020529	12	M6	-	-	94
DIXIE PART NUMBERS						
A-1213	19020505	12	M6	-	-	78
A-1225	10459338	12	M6	PIN	-	94
A-1246	10459350	12	M6	PIN	-	78
MIDLAND PART NUMBER						
RA112010X	19020505	12	M6	-	-	78
WILSON PART NUMBERS						
90-01-3145	19020505	12	M6	-	-	78
90-01-3147	10459350	12	M6	PIN	-	78
90-01-3171	10459338	12	M6	PIN	-	94

15SI



Part Number	Reman Number	Battery Volts	Term	R Term	I Term	Amps
DELCO REMY REMANUFACTURED PART NUMBERS						
10459366	10459366	12	-	-	-	105
10459367	10459367	12	M6	-	-	105
19020506	19020506	12	M6	PIN	-	70
DELCO REMY O.E. PART NUMBERS						
1101041	19020506	12	M6	PIN	-	70
1101449	19020506	12	M6	PIN	-	70

Part Number	Reman Number	Battery Volts	Term	R Term	I Term	Amps
DELCO REMY O.E. PART NUMBERS (CONT.)						
1105186	19020506	12	M6	PIN	-	70
1105197	19020506	12	M6	PIN	-	70
1105250	19020506	12	M6	PIN	-	70
1105332	19020506	12	M6	PIN	-	70
1105335	19020506	12	M6	PIN	-	70
1105512	19020506	12	M6	PIN	-	70
1105536	10459367	12	M6	-	-	105

15SI (cont.)

Part Number	Reman Number	Battery Volts	Term	R Term	I Term	Amps
-------------	--------------	---------------	------	--------	--------	------

DELCO REMY O.E. PART NUMBERS (CONT.)

1105560	10459366	12	-	-	-	105
10479825	19020506	12	M6	PIN	-	70

AC DELCO CATALOG NUMBERS

321-137	19020506	12	M6	PIN	-	70
321-138	19020506	12	M6	PIN	-	70
321-139	19020506	12	M6	PIN	-	70
321-234	19020506	12	M6	PIN	-	70
321-667	10459367	12	M6	-	-	105

CARGO PART NUMBER

110235	19020506	12	M6	PIN	-	70
--------	-----------------	----	----	-----	---	----

Part Number	Reman Number	Battery Volts	Term	R Term	I Term	Amps
-------------	--------------	---------------	------	--------	--------	------

CUMMINS RECON PART NUMBER

3604474RX	10459367	12	M6	-	-	105
-----------	-----------------	----	----	---	---	-----

DIXIE PART NUMBERS

A-1150	19020506	12	M6	PIN	-	70
A-1151	19020506	12	M6	PIN	-	70
A-1153	19020506	12	M6	PIN	-	70
A-1250	10459367	12	M6	-	-	105

KOMATSU PART NUMBER

ALT1003	10459366	12	-	-	-	105
---------	-----------------	----	---	---	---	-----

WILSON PART NUMBERS

90-01-3109	19020506	12	M6	PIN	-	70
90-01-3151	10459367	12	M6	-	-	105

19SI

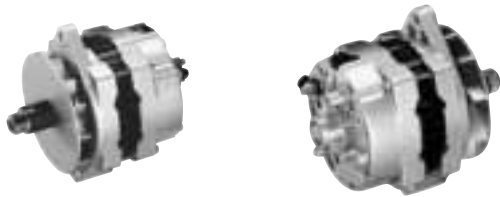

Part Number	Reman Number	Battery Volts	Term	R Term	I Term	Amps
-------------	--------------	---------------	------	--------	--------	------

DELCO REMY REMANUFACTURED PART NUMBERS

10459304	10459304	12	M6	BLADE	BLADE	130
10459316	10459316	12	M6	BLADE	BLADE	105
10459469	10459469	12	M6	M4	-	105

DELCO REMY O.E. PART NUMBERS

19009950	10459469	12	M6	M4	-	105
19009952	10459469	12	M6	M4	-	105
19009957	10459316	12	M6	BLADE	BLADE	105
19009958	10459304	12	M6	BLADE	BLADE	130

Part Number	Reman Number	Battery Volts	Term	R Term	I Term	Amps
-------------	--------------	---------------	------	--------	--------	------

AC DELCO CATALOG NUMBER

321-767	10459316	12	M6	BLADE	BLADE	105
---------	-----------------	----	----	-------	-------	-----

CUMMINS RECON PART NUMBERS

3675256RX	10459316	12	M6	BLADE	BLADE	105
-----------	-----------------	----	----	-------	-------	-----

20SI

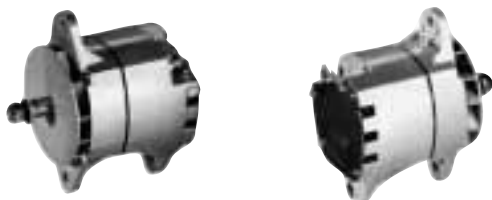

Part Number	Reman Number	Battery Volts	Term	R Term	I Term	Amps
-------------	--------------	---------------	------	--------	--------	------

DELCO REMY REMANUFACTURED PART NUMBERS

1117655	1117655	24	1/4	PIN	-	35
10459020	10459020	12	1/4	PIN	-	60
10459252	10459252	12	1/4	#10	-	60
10459319	10459319	24	1/4	PIN	-	45

Part Number	Reman Number	Battery Volts	Term	R Term	I Term	Amps
-------------	--------------	---------------	------	--------	--------	------

DELCO REMY O.E. PART NUMBERS

1117611	10459252	12	1/4	#10	-	60
1117612	10459252	12	1/4	#10	-	60
1117614	10459319	24	1/4	PIN	-	45
1117615	10459319	24	1/4	PIN	-	45
1117616	10459252	12	1/4	#10	-	60

REMANUFACTURED ALTERNATORS



20SI (cont.)

Part Number	Reman Number	Battery Volts	Term	R Term	I Term	Amps
DELCO REMY O.E. PART NUMBERS (CONT.)						
1117618	10459252	12	1/4	#10	-	60
1117619	10459319	24	1/4	PIN	-	45
1117620	10459020	12	1/4	PIN	-	60
1117621	10459020	12	1/4	PIN	-	60
1117622	10459319	24	1/4	PIN	-	45
1117623	1117655	24	1/4	PIN	-	35
1117624	10459252	12	1/4	#10	-	60
1117628	10459020	12	1/4	PIN	-	60
1117631	1117655	24	1/4	PIN	-	35
1117640	1117655	24	1/4	PIN	-	35
1117641	10459020	12	1/4	PIN	-	60
1117642	10459319	24	1/4	PIN	-	45
1117643	10459319	24	1/4	PIN	-	45
1117644	1117655	24	1/4	PIN	-	35
1117645	10459319	24	1/4	PIN	-	45
1117647	1117655	24	1/4	PIN	-	35
10459200	10459020	12	1/4	PIN	-	60
AC DELCO CATALOG NUMBERS						
321-660	1117655	24	1/4	PIN	-	35
321-665	10459319	24	1/4	PIN	-	45
321-666	10459020	12	1/4	PIN	-	60
321-753	10459252	12	1/4	#10	-	60

Part Number	Reman Number	Battery Volts	Term	R Term	I Term	Amps
CARGO PART NUMBER						
110801	10459319	24	1/4	PIN	-	45
CUMMINS RECON PART NUMBERS						
3016628RX	10459020	12	1/4	PIN	-	60
3604473RX	10459020	12	1/4	PIN	-	60
3604676RX	10459319	24	1/4	PIN	-	45
3675126RX	1117655	24	1/4	PIN	-	35
DIXIE PART NUMBERS						
A-1117	10459319	24	1/4	PIN	-	45
A-1118	10459020	12	1/4	PIN	-	60
A-1118	10459252	12	1/4	#10	-	60
KOMATSU PART NUMBER						
ALT1004	10459319	24	1/4	PIN	-	45
WILSON PART NUMBERS						
90-01-3127	10459020	12	1/4	PIN	-	60
90-01-3127	10459252	12	1/4	#10	-	60
90-01-3157	10459319	24	1/4	PIN	-	45

21SI



Note:
 R Terminals Carry Half Voltage
 I Terminals Carry Full System Voltage
 **three-wire alternator

Part Number	Reman Number	Battery Volts	Term	R Term	I Term	Amps
DELCO REMY REMANUFACTURED PART NUMBERS						
10459013	10459013	12	1/4	P/T	#10	100
10459037	10459037	12	1/4	P/T	#10	130
10459046	10459046**	12	1/4	-	#10	100
10459051	10459051	12	1/4	P/T	#10	145
10459187	10459187	12	5/16	PIN	-	145
10459261	10459261	24	1/4	PIN	#10	70
10459336	10459336	12	5/16	#10	#10	160
10459453	10459453**	12	1/4	-	#10	130
10459457	10459457**	12	5/16	#10	-	160
10459460	10459460**	12	5/16	#10	-	160
10459461	10459461	24	M6	M4	M4	50
10459462	10459462	12	5/16	#10	#10	145
10459463	10459463**	12	1/4	#10	-	100
10459547	10459547	12	5/16	#10	-	125
10461235	10461235	24	M6	M4	M4	70
DELCO REMY O.E. PART NUMBERS						
1117880	10459013	12	1/4	P/T	#10	100

Part Number	Reman Number	Battery Volts	Term	R Term	I Term	Amps
DELCO REMY O.E. PART NUMBERS (CONT.)						
1117885	10459013	12	1/4	P/T	#10	100
1117886	10459013	12	1/4	P/T	#10	100
1117887	10459013	12	1/4	P/T	#10	100
1117889	10459013	12	1/4	P/T	#10	100
1117890	10459013	12	1/4	P/T	#10	100
1117891	10459037	12	1/4	P/T	#10	130
1117892	10459013	12	1/4	P/T	#10	100
1117893	10459037	12	1/4	P/T	#10	130
1117894	10459013	12	1/4	P/T	#10	100
1117896	10459453**	12	1/4	-	#10	130
1117898	10459547	12	5/16	#10	-	125
1117899	10459457**	12	5/16	#10	-	160
1117900	10461235	24	M6	M4	M4	70
1117903	10459046**	12	1/4	-	#10	100
1117904	10459453**	12	1/4	-	#10	130
1117905	10459013	12	1/4	P/T	#10	100
1117906	10459037	12	1/4	P/T	#10	130

21SI (cont.)

Remanufactured Alternators

Part Number	Reman Number	Battery Volts	Term	R Term	I Term	Amps
DELCO REMY O.E. PART NUMBERS (CONT.)						
1117907	10459046**	12	1/4	-	#10	100
1117908	10459453**	12	1/4	-	#10	130
1117909	10459037	12	1/4	P/T	#10	130
1117910	10459037	12	1/4	P/T	#10	130
1117911	10459037	12	1/4	P/T	#10	130
1117914	10459037	12	1/4	P/T	#10	130
1117916	10459051	12	1/4	P/T	#10	145
1117918	10459037	12	1/4	P/T	#10	130
1117921	10459051	12	1/4	P/T	#10	145
1117923	10459037	12	1/4	P/T	#10	130
1117925	10459013	12	1/4	P/T	#10	100
1117926	10459460**	12	5/16	#10	-	160
1117927	10459046**	12	1/4	-	#10	100
1117928	10459453**	12	1/4	-	#10	130
1117929	10459037	12	1/4	P/T	#10	130
1117930	10459013	12	1/4	P/T	#10	100
1117931	10459013	12	1/4	P/T	#10	100
1117932	10459037	12	1/4	P/T	#10	130
1117933	10459051	12	1/4	P/T	#10	145
1117937	10459013	12	1/4	P/T	#10	100
1117938	10459457**	12	5/16	#10	-	160
1117941	10459037	12	1/4	P/T	#10	130
1117942	10459013	12	1/4	P/T	#10	100
1117943	10459037	12	1/4	P/T	#10	130
1117946	10459037	12	1/4	P/T	#10	130
1117947	10459037	12	1/4	P/T	#10	130
1117948	10459051	12	1/4	P/T	#10	145
1117949	10459037	12	1/4	P/T	#10	130
1117950	10459013	12	1/4	P/T	#10	100
1117951	10459037	12	1/4	P/T	#10	130
1117952	10459051	12	1/4	P/T	#10	145
1117953	10459013	12	1/4	P/T	#10	100
1117954	10459013	12	1/4	P/T	#10	100
1117955	10459013	12	1/4	P/T	#10	100
1117956	10459013	12	1/4	P/T	#10	100
1117957	10459037	12	1/4	P/T	#10	130
1117958	10459037	12	1/4	P/T	#10	130
1117959	10459037	12	1/4	P/T	#10	130
1117960	10459013	12	1/4	P/T	#10	100
1117961	10459037	12	1/4	P/T	#10	130
1117962	10459037	12	1/4	P/T	#10	130
1117963	10459037	12	1/4	P/T	#10	130
1117964	10459051	12	1/4	P/T	#10	145
1117965	10459037	12	1/4	P/T	#10	130
1117966	10459037	12	1/4	P/T	#10	130
19010100	10459013	12	1/4	P/T	#10	100
19010101	10459013	12	1/4	P/T	#10	100
19010102	10459013	12	1/4	P/T	#10	100
19010103	10459013	12	1/4	P/T	#10	100
19010104	10459037	12	1/4	P/T	#10	130
19010105	10459013	12	1/4	P/T	#10	100
19010108	10459461	24	M6	M4	M4	50
19010110	10459457**	12	5/16	#10	-	160
19010111	10461235	24	M6	M4	M4	70
19010112	10459046**	12	1/4	-	#10	100
19010114	10459013	12	1/4	P/T	#10	100

Part Number	Reman Number	Battery Volts	Term	R Term	I Term	Amps
DELCO REMY O.E. PART NUMBERS (CONT.)						
19010115	10459037	12	1/4	P/T	#10	130
19010116	10459037	12	1/4	P/T	#10	130
19010118	10459463**	12	1/4	#10	-	100
19010120	10459037	12	1/4	P/T	#10	130
19010124	10459037	12	1/4	P/T	#10	130
19010125	10459051	12	1/4	P/T	#10	145
19010126	10459336	12	5/16	#10	#10	160
19010127	10459051	12	1/4	P/T	#10	145
19010129	10459037	12	1/4	P/T	#10	130
19010134	10459037	12	1/4	P/T	#10	130
19010136	10459013	12	1/4	P/T	#10	100
19010137	10459037	12	1/4	P/T	#10	130
19010138	10459051	12	1/4	P/T	#10	145
19010141	10459013	12	1/4	P/T	#10	100
19010145	10459037	12	1/4	P/T	#10	130
19010146	10459013	12	1/4	P/T	#10	100
19010147	10459037	12	1/4	P/T	#10	130
19010150	10459037	12	1/4	P/T	#10	130
19010153	10459037	12	1/4	P/T	#10	130
19010154	10459013	12	1/4	P/T	#10	100
19010155	10459037	12	1/4	P/T	#10	130
19010156	10459051	12	1/4	P/T	#10	145
19010157	10459013	12	1/4	P/T	#10	100
19010158	10459013	12	1/4	P/T	#10	100
19010159	10459013	12	1/4	P/T	#10	100
19010160	10459013	12	1/4	P/T	#10	100
19010161	10459037	12	1/4	P/T	#10	130
19010162	10459037	12	1/4	P/T	#10	130
19010163	10459037	12	1/4	P/T	#10	130
19010164	10459013	12	1/4	P/T	#10	100
19010165	10459037	12	1/4	P/T	#10	130
19010166	10459037	12	1/4	P/T	#10	130
19010168	10459462	12	5/16	#10	#10	145
19010170	10459037	12	1/4	P/T	#10	130
19010171	10459037	12	1/4	P/T	#10	130
19010172	10459037	12	1/4	P/T	#10	130
19010173	10459037	12	1/4	P/T	#10	130
19010174	10459051	12	1/4	P/T	#10	145
19010175	10459051	12	1/4	P/T	#10	145
19010176	10459051	12	1/4	P/T	#10	145
19010179	10459051	12	1/4	P/T	#10	145
19010180	10459187	12	5/16	PIN	-	145
19010181	10459013	12	1/4	P/T	#10	100
19010182	10461235	24	M6	M4	M4	70
19010185	10459261	24	1/4	PIN	#10	70
19010186	10459013	12	1/4	P/T	#10	100
19010187	10459037	12	1/4	P/T	#10	130
19010188	10459037	12	1/4	P/T	#10	130
19010189	10459051	12	1/4	P/T	#10	145
19010190	10459013	12	1/4	P/T	#10	100
19010191	10459037	12	1/4	P/T	#10	130
19010192	10459051	12	1/4	P/T	#10	145
19010194	10459013	12	1/4	P/T	#10	100
19010195	10461235	24	M6	M4	M4	70
19010196	10459037	12	1/4	P/T	#10	130
19010200	10459261	24	1/4	PIN	#10	70

REMANUFACTURED ALTERNATORS



21SI (cont.)

Part Number	Reman Number	Battery Volts	Term	R Term	I Term	Amps
DELCO REMY O.E. PART NUMBERS (CONT.)						
19010207	10459037	12	1/4	P/T	#10	130
19010209	10459013	12	1/4	P/T	#10	100
19010210	10459037	12	1/4	P/T	#10	130
19010212	10459037	12	1/4	P/T	#10	130
19010213	10459013	12	1/4	P/T	#10	100
10459017	10459013	12	1/4	P/T	#10	100
10459026	10459013	12	1/4	P/T	#10	100
10459027	10459046**	12	1/4	-	#10	100
10459028	10459453**	12	1/4	-	#10	130
10459035	10459013	12	1/4	P/T	#10	100
10459036	10459013	12	1/4	P/T	#10	100
10459038	10459037	12	1/4	P/T	#10	130
10459039	10459013	12	1/4	P/T	#10	100
10459040	10459037	12	1/4	P/T	#10	130
10459041	10459037	12	1/4	P/T	#10	130
10459042	10459013	12	1/4	P/T	#10	100
10459043	10459013	12	1/4	P/T	#10	100
10459044	10459013	12	1/4	P/T	#10	100
10459045	10459013	12	1/4	P/T	#10	100
10459047	10459037	12	1/4	P/T	#10	130
10459048	10459037	12	1/4	P/T	#10	130
10459049	10459453**	12	1/4	-	#10	130
10459050	10459051	12	1/4	P/T	#10	145
10459052	10459051	12	1/4	P/T	#10	145
10459053	10459051	12	1/4	P/T	#10	145
10459054	10459051	12	1/4	P/T	#10	145
10459055	10459013	12	1/4	P/T	#10	100
10459059	10459037	12	1/4	P/T	#10	130
10459082	10459013	12	1/4	P/T	#10	100
10459104	10459013	12	1/4	P/T	#10	100
10459105	10459037	12	1/4	P/T	#10	130
10459106	10459051	12	1/4	P/T	#10	145
10459107	10459013	12	1/4	P/T	#10	100
10459109	10459013	12	1/4	P/T	#10	100
10459111	10459037	12	1/4	P/T	#10	130
10459115	10459013	12	1/4	P/T	#10	100
10459117	10459037	12	1/4	P/T	#10	130
10459118	10459051	12	1/4	P/T	#10	145
10459133	10459051	12	1/4	P/T	#10	145
10459134	10459013	12	1/4	P/T	#10	100
10459135	10459037	12	1/4	P/T	#10	130
10459147	10459013	12	1/4	P/T	#10	100
10459154	10459013	12	1/4	P/T	#10	100
10459155	10459037	12	1/4	P/T	#10	130
10459156	10459051	12	1/4	P/T	#10	145
10459157	10459013	12	1/4	P/T	#10	100
10459158	10459013	12	1/4	P/T	#10	100
10459159	10459037	12	1/4	P/T	#10	130
10459160	10459051	12	1/4	P/T	#10	145
10459174	10459013	12	1/4	P/T	#10	100
10459175	10459037	12	1/4	P/T	#10	130
10459176	10459051	12	1/4	P/T	#10	145
10459177	10459013	12	1/4	P/T	#10	100
10459178	10459037	12	1/4	P/T	#10	130
10459179	10459051	12	1/4	P/T	#10	145
10459185	10459013	12	1/4	P/T	#10	100

Part Number	Reman Number	Battery Volts	Term	R Term	I Term	Amps
DELCO REMY O.E. PART NUMBERS (CONT.)						
10459209	10459013	12	1/4	P/T	#10	100
10459210	10459037	12	1/4	P/T	#10	130
10459211	10459051	12	1/4	P/T	#10	145
10459262	10459261	24	1/4	PIN	#10	70
10459302	10459013	12	1/4	P/T	#10	100
10461236	10459037	12	1/4	P/T	#10	130

AC DELCO CATALOG NUMBERS

321-674	10459013	12	1/4	P/T	#10	100
321-676	10459046**	12	1/4	-	#10	100
321-677	10459453**	12	1/4	-	#10	130
321-681	10459013	12	1/4	P/T	#10	100
321-682	10459013	12	1/4	P/T	#10	100
321-683	10459037	12	1/4	P/T	#10	130
321-684	10459037	12	1/4	P/T	#10	130
321-685	10459013	12	1/4	P/T	#10	100
321-687	10459037	12	1/4	P/T	#10	130
321-688	10459051	12	1/4	P/T	#10	145
321-689	10459051	12	1/4	P/T	#10	145
321-701	10459013	12	1/4	P/T	#10	100
321-715	10459013	12	1/4	P/T	#10	100
321-716	10459037	12	1/4	P/T	#10	130
321-717	10459051	12	1/4	P/T	#10	145
321-718	10459013	12	1/4	P/T	#10	100
321-719	10459013	12	1/4	P/T	#10	100
321-720	10459037	12	1/4	P/T	#10	130
321-721	10459051	12	1/4	P/T	#10	145
321-737	10459187	12	5/16	PIN	-	145
321-756	10459261	24	1/4	PIN	#10	70

CARGO PART NUMBER

111232	10459013	12	1/4	P/T	#10	100
--------	----------	----	-----	-----	-----	-----

CUMMINS RECON PART NUMBERS

3604666RX	10459013	12	1/4	P/T	#10	100
3604667RX	10459037	12	1/4	P/T	#10	130
3604668RX	10459051	12	1/4	P/T	#10	145
3604669RX	10459051	12	1/4	P/T	#10	145
3675156RX	10459463**	12	1/4	#10	-	100
3675157RX	10459453**	12	1/4	-	#10	130
3675158RX	10459336	12	5/16	#10	#10	160
3675159RX	10459460**	12	5/16	#10	-	160
3675174RX	10461235	24	M6	M4	M4	70
3675201RX	10459461	24	M6	M4	M4	50

DDC CATALOG NUMBERS

R0459109	10459013	12	1/4	P/T	#10	100
R0459111	10459037	12	1/4	P/T	#10	130
R0459133	10459051	12	1/4	P/T	#10	145
R0459134	10459013	12	1/4	P/T	#10	100
R0459135	10459037	12	1/4	P/T	#10	130
R0459457	10459457**	12	5/16	#10	-	160

DDC PART NUMBERS

10459109	10459013	12	1/4	P/T	#10	100
10459111	10459037	12	1/4	P/T	#10	130
10459133	10459051	12	1/4	P/T	#10	145
10459134	10459013	12	1/4	P/T	#10	100

21SI (cont.)

Part Number	Reman Number	Volts	Battery Term	R Term	I Term	Amps
DDC PART NUMBERS (CONT.)						
10459135	10459037	12	1/4	P/T	#10	130
10459457	10459457**	12	5/16	#10	-	160

Part Number	Reman Number	Volts	Battery Term	R Term	I Term	Amps
DIXIE PART NUMBERS						
A-1341	10459013	12	1/4	P/T	#10	100
A-1342	10459037	12	1/4	P/T	#10	130
A-1350	10459051	12	1/4	P/T	#10	145
A-1353	10459013	12	1/4	P/T	#10	100
A-1354	10459046**	12	1/4	-	#10	100
A-1355	10459453**	12	1/4	-	#10	130
A-1358	10459037	12	1/4	P/T	#10	130
A-1359	10459051	12	1/4	P/T	#10	145
A-1360	10459037	12	1/4	P/T	#10	130
A-1545	10459187	12	5/16	PIN	-	145
A-1360	10459336	12	5/16	#10	#10	160

Part Number	Reman Number	Volts	Battery Term	R Term	I Term	Amps
KOMATSU PART NUMBERS						
ALT1022	10461235	24	M6	M4	M4	70
ALT1023	10459461	24	M6	M4	M4	50

Part Number	Reman Number	Volts	Battery Term	R Term	I Term	Amps
MIDLAND PART NUMBERS						
RA121000X	10459013	12	1/4	P/T	#10	100
RA121001X	10459037	12	1/4	P/T	#10	130
RA121002X	10459051	12	1/4	P/T	#10	145
RA121008X	10459037	12	1/4	P/T	#10	130
RA121009X	10459013	12	1/4	P/T	#10	100

Part Number	Reman Number	Volts	Battery Term	R Term	I Term	Amps
MIDLAND PART NUMBERS (CONT.)						
RA121010X	10459013	12	1/4	P/T	#10	100
RA121011X	10459453**	12	1/4	-	#10	130
RA121015X	10459013	12	1/4	P/T	#10	100
RA121016X	10459046**	12	1/4	-	#10	100
RA121017X	10459051	12	1/4	P/T	#10	145
RA121018X	10459013	12	1/4	P/T	#10	100
RA121019X	10459013	12	1/4	P/T	#10	100
RA121020X	10459037	12	1/4	P/T	#10	130
RA121021X	10459051	12	1/4	P/T	#10	145
RA121022X	10459013	12	1/4	P/T	#10	100
RA121023X	10459013	12	1/4	P/T	#10	100
RA121024X	10459037	12	1/4	P/T	#10	130
RA121025X	10459051	12	1/4	P/T	#10	145

Part Number	Reman Number	Volts	Battery Term	R Term	I Term	Amps
WILSON PART NUMBERS						
90-01-4058	10459013	12	1/4	P/T	#10	100
90-01-4072	10459051	12	1/4	P/T	#10	145
90-01-4074	10459037	12	1/4	P/T	#10	130
90-01-4093	10459037	12	1/4	P/T	#10	130
90-01-4093	10459051	12	1/4	P/T	#10	145
90-01-4105	10459013	12	1/4	P/T	#10	100
90-01-4109	10459051	12	1/4	P/T	#10	145
90-01-4113	10459013	12	1/4	P/T	#10	100
90-01-4118	10459046**	12	1/4	-	#10	100
90-01-4119	10459037	12	1/4	P/T	#10	130

22SI



Part Number	Reman Number	Volts	Battery Term	R Term	I Term	Amps
DELCO REMY REMANUFACTURED PART NUMBERS						
10459188	10459188	12	5/16	#10	#10	100
10459189	10459189	12	5/16	#10	#10	130
10459190	10459190	12	5/16	#10	#10	145
10459204	10459204	12	1/4	PIN	#10	100
10459205	10459205	12	1/4	PIN	#10	145
10459212	10459212	12	1/4	PIN	#10	130
10459306	10459306	24	M6	M4	M4	70
10459333	10459333	24	M6	M4	M4	70
10459334	10459334	24	M6	M4	BLADE	70
10459360	10459360	12	1/4	PIN	#10	100
10459456	10459456	12	M6	M4	BLADE	130
10459468	10459468	24	M6	M4	M4	50
10459472	10459472	12	1/4	PIN	#10	160
10459601	10459601	12	5/16	#10	-	145

Part Number	Reman Number	Volts	Battery Term	R Term	I Term	Amps
DELCO REMY O.E. PART NUMBERS						
19020300	10459188	12	5/16	#10	#10	100
19020302	10459189	12	5/16	#10	#10	130
19020303	10459190	12	5/16	#10	#10	145
19020304	10459212	12	1/4	PIN	#10	130
19020305	10459204	12	1/4	PIN	#10	100
19020306	10459205	12	1/4	PIN	#10	145
19020307	10459306	24	M6	M4	M4	70
19020312	10459360	12	1/4	PIN	#10	100
19020346	10459333	24	M6	M4	M4	70
19020354	10459360	12	1/4	PIN	#10	100
19020358	10459190	12	5/16	#10	#10	145
19020359	10459190	12	5/16	#10	#10	145
19020360	10459360	12	1/4	PIN	#10	100
19020362	10459360	12	1/4	PIN	#10	100
19020363	10459360	12	1/4	PIN	#10	100
19020365	10459190	12	5/16	#10	#10	145

REMANUFACTURED ALTERNATORS



21SI (cont.)

Part Number	Reman Number	Battery Volts	Battery Term	R Term	I Term	Amps
DELCO REMY O.E. PART NUMBERS (CONT.)						
19020364	10459190	12	5/16	#10	#10	145
19020366	10459468	24	M6	M4	M4	50
19020375	10459456	12	M6	M4	BLADE	130
19020377	10459188	12	5/16	#10	#10	100
19020379	10459204	12	1/4	PIN	#10	100
19020380	10459212	12	1/4	PIN	#10	130
19020381	10459472	12	1/4	PIN	#10	160
19020382	10459306	24	M6	M4	M4	70
19020383	10459468	24	M6	M4	M4	50
19020391	10459334	24	M6	M4	BLADE	70
19020801	10459189	12	5/16	#10	#10	130
19020806	10459188	12	5/16	#10	#10	100
19020823	10459601	12	5/16	#10	-	145

AC DELCO CATALOG NUMBERS

321-738	10459188	12	5/16	#10	#10	100
321-739	10459189	12	5/16	#10	#10	130
321-740	10459190	12	5/16	#10	#10	145
321-749	10459205	12	1/4	PIN	#10	145
321-750	10459204	12	1/4	PIN	#10	100

CUMMINS RECON PART NUMBERS

3675222RX	10459360	12	1/4	PIN	#10	100
3675225RX	10459456	12	M6	M4	BLADE	130
3675226RX	10459468	24	M6	M4	M4	50
3675229RX	10459472	12	1/4	PIN	#10	160

Part Number	Reman Number	Battery Volts	Battery Term	R Term	I Term	Amps
DIXIE PART NUMBERS						
A-1450	10459188	12	5/16	#10	#10	100
A-1451	10459189	12	5/16	#10	#10	130
A-1452	10459190	12	5/16	#10	#10	145
A-1492	10459204	12	1/4	PIN	#10	100
A-1493	10459212	12	1/4	PIN	#10	130
A-1494	10459205	12	1/4	PIN	#10	145
A-1609	10459468	24	M6	M4	M4	50

KOMATSU PART NUMBER

ALT1025	10459306	24	M6	M4	M4	70
---------	----------	----	----	----	----	----

MIDLAND PART NUMBERS

RA122000X	10459188	12	5/16	#10	#10	100
RA122001X	10459189	12	5/16	#10	#10	130
RA122002X	10459190	12	5/16	#10	#10	145
RA122003X	10459204	12	1/4	PIN	#10	100
RA122004X	10459212	12	1/4	PIN	#10	130
RA122005X	10459205	12	1/4	PIN	#10	145

WILSON PART NUMBERS

90-01-4267	10459189	12	5/16	#10	#10	130
90-01-4269	10459188	12	5/16	#10	#10	100
90-01-4297	10459190	12	5/16	#10	#10	145

22SI PAD Mount



Part Number	Reman Number	Battery Volts	Battery Term	R Term	I Term	Amps
DELCO REMY REMANUFACTURED PART NUMBERS						
10459318	10459318	12	5/16	#10	#10	100
10459320	10459320	12	5/16	#10	#10	130
10459321	10459321	12	5/16	#10	#10	145
10459481	10459481	12	M10	PLUG	PLUG	100
10459482	10459482	12	M10	PLUG	PLUG	160
10459483	10459483	12	M10	PLUG	PLUG	130
10459596	10459596	12	M10	PLUG	PLUG	160
10459602	10459602	12	5/16	#10	#10	130
10459603	10459603	12	5/16	#10	#10	145

DELCO REMY O.E. PART NUMBERS

19020378	10459482	12	M10	PLUG	PLUG	160
19020384	10459483	12	M10	PLUG	PLUG	130
19020385	10459481	12	M10	PLUG	PLUG	100
19020387	10459318	12	5/16	#10	#10	100
19020388	10459320	12	5/16	#10	#10	130

Part Number	Reman Number	Battery Volts	Battery Term	R Term	I Term	Amps
DELCO REMY O.E. PART NUMBERS (CONT.)						
19020808	10459318	12	5/16	#10	#10	100
19020810	10459481	12	M10	PLUG	PLUG	100
19020811	10459482	12	M10	PLUG	PLUG	160
19020812	10459483	12	M10	PLUG	PLUG	130
19020824	10459602	12	5/16	#10	#10	130
19020825	10459603	12	5/16	#10	#10	145

AC DELCO CATALOG NUMBERS

321-796	10459481	12	M10	PLUG	PLUG	100
321-797	10459482	12	M10	PLUG	PLUG	160
321-798	10459483	12	M10	PLUG	PLUG	130

REMANUFACTURED ALTERNATORS

22SI PAD Mount (cont.)

Part Number	Reman Number	Battery Volts	Term	R Term	I Term	Amps
DDC CATALOG NUMBERS						
R0459340	10459321	12	5/16	#10	#10	145
R0459341	10459320	12	5/16	#10	#10	130
R0459342	10459318	12	5/16	#10	#10	100

Part Number	Reman Number	Battery Volts	Term	R Term	I Term	Amps
DDC PART NUMBERS						
10459340	10459321	12	5/16	#10	#10	145
10459341	10459320	12	5/16	#10	#10	130
10459342	10459318	12	5/16	#10	#10	100

23SI

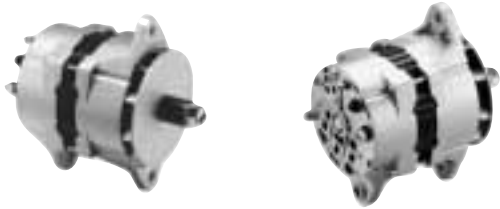

Part Number	Reman Number	Battery Volts	Term	R Term	I Term	Amps
DELCO REMY REMANUFACTURED PART NUMBERS						
10459218	10459218	12	1/4	#10	#10	100
10459274	10459274	24	5/16	#10	#10	70
10459275	10459275	12	1/4	PIN	#10	100
10459277	10459277	12	1/4	#10	#10	145
10459294	10459294	12	1/4	#10	#10	100
10459303	10459303	12	5/16	#10	#10	130
10459372	10459372	24	5/16	#10	#10	50

Part Number	Reman Number	Battery Volts	Term	R Term	I Term	Amps
DELCO REMY O.E. PART NUMBERS (CONT.)						
19011016	10459294	12	1/4	#10	#10	100
19011017	10459303	12	5/16	#10	#10	130
19011019	10459274	24	5/16	#10	#10	70

AC DELCO CATALOG NUMBERS

321-759	10459274	24	5/16	#10	#10	70
321-760	10459277	12	1/4	#10	#10	145
321-761	10459218	12	1/4	#10	#10	100
321-762	10459275	12	1/4	PIN	#10	100

DDC CATALOG NUMBER

R0459372	10459372	24	5/16	#10	#10	50
----------	-----------------	----	------	-----	-----	----

DDC PART NUMBER

10459372	10459372	24	5/16	#10	#10	50
----------	-----------------	----	------	-----	-----	----

24SI



Part Number	Reman Number	Battery Volts	Term	Gnd Term	Mtg	Amps
DELCO REMY REMANUFACTURED PART NUMBERS						
8700008	8700008	12	5/16	1/4	PAD	145
8700009	8700009	24	5/16	1/4	J180	70
8700010	8700010	12	5/16	1/4	J180	130
8700011	8700011	12	5/16	1/4	J180	100
8700012	8700012	12	5/16	1/4	PAD	130
8700013	8700013	12	5/16	1/4	PAD	160
8700019	8700019	24	5/16	1/2	J180	70
8700021	8700021	12	5/16	CONN	J180	160

Part Number	Reman Number	Battery Volts	Term	Gnd Term	Mtg	Amps
DELCO REMY O.E. PART NUMBERS						
8600009	8700011	12	5/16	1/4	J180	100
8600017	8700019	24	5/16	1/2	J180	70
8600018	8700010	12	5/16	1/4	J180	130
8600019	8700021	12	5/16	CONN	J180	160
8600020	8700019	24	5/16	1/2	J180	70
8600032	8700011	12	5/16	1/4	J180	100
8600043	8700013	12	5/16	1/4	PAD	160
8600068	8700021	12	5/16	CONN	J180	160
19020900	8700008	12	5/16	1/4	PAD	145
19020901	8700009	12	5/16	1/4	J180	145
19020902	8700012	12	5/16	1/4	PAD	130
19020903	8700010	12	5/16	1/4	J180	130

REMANUFACTURED ALTERNATORS



25SI & 26SI

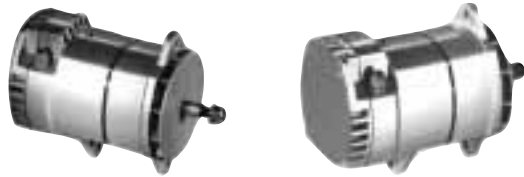

Remanufactured Alternators

Part Number	Reman Number	Volts	Battery Term	R Term	I Term	Amps
DELCO REMY REMANUFACTURED PART NUMBERS						
10459064	10459064	24	7/16	PIN	-	50
10459065	10459065	12	7/16	PIN	-	85
10459066	10459066	12	7/16	-	#10	85
10459067	10459067	12	1/4	PIN	-	85
10459076	10459076	24	7/16	PIN	-	75
10459077	10459077	12	7/16	PIN	-	75
10459161	10459161	12	1/4	-	#10	85
10459245	10459245	24	7/16	-	#10	50

Part Number	Reman Number	Volts	Battery Term	R Term	I Term	Amps
DELCO REMY O.E. PART NUMBERS						
1117069	10459076	24	7/16	PIN	-	75
1117224	10459064	24	7/16	PIN	-	50
1117225	10459077	12	7/16	PIN	-	75
1117226	10459064	24	7/16	PIN	-	50
1117227	10459077	12	7/16	PIN	-	75
1117228	10459077	12	7/16	PIN	-	75
1117231	10459077	12	7/16	PIN	-	75
1117234	10459077	12	7/16	PIN	-	75
1117236	10459064	24	7/16	PIN	-	50
1117238	10459076	24	7/16	PIN	-	75
1117239	10459064	24	7/16	PIN	-	50
1117240	10459077	12	7/16	PIN	-	75
1117241	10459077	12	7/16	PIN	-	75
1117242	10459077	12	7/16	PIN	-	75
1117243	10459064	24	7/16	PIN	-	50
1117244	10459077	12	7/16	PIN	-	75
1117248	10459064	24	7/16	PIN	-	50
1117249	10459076	24	7/16	PIN	-	75
1117250	10459064	24	7/16	PIN	-	50
1117251	10459077	12	7/16	PIN	-	75
1117253	10459064	24	7/16	PIN	-	50
1117254	10459245	24	7/16	-	#10	50
1117255	10459077	12	7/16	PIN	-	75
1117256	10459076	24	7/16	PIN	-	75
1117258	10459064	24	7/16	PIN	-	50
1117259	10459077	12	7/16	PIN	-	75
1117260	10459077	12	7/16	PIN	-	75
1117261	10459077	12	7/16	PIN	-	75
1117262	10459077	12	7/16	PIN	-	75
1117263	10459077	12	7/16	PIN	-	75
1117264	10459065	12	7/16	PIN	-	85
1117265	10459065	12	7/16	PIN	-	85
1117266	10459065	12	7/16	PIN	-	85
1117267	10459077	12	7/16	PIN	-	75
1117268	10459065	12	7/16	PIN	-	85
1117269	10459065	12	7/16	PIN	-	85
1117270	10459065	12	7/16	PIN	-	85
1117272	10459065	12	7/16	PIN	-	85
1117273	10459065	12	7/16	PIN	-	85

Part Number	Reman Number	Volts	Battery Term	R Term	I Term	Amps
DELCO REMY O.E. PART NUMBERS (CONT.)						
1117274	10459067	12	1/4	PIN	-	85
1117279	10459066	12	7/16	-	#10	85
1117281	10459076	24	7/16	PIN	-	75
1117282	10459064	24	7/16	PIN	-	50
10459003	10459077	12	7/16	PIN	-	75
10459006	10459064	24	7/16	PIN	-	50
10459007	10459076	24	7/16	PIN	-	75
10459011	10459076	24	7/16	PIN	-	75
10459014	10459065	12	7/16	PIN	-	85
10459015	10459065	12	7/16	PIN	-	85
10459018	10459077	12	7/16	PIN	-	75
10459019	10459065	12	7/16	PIN	-	85
10459061	10459064	24	7/16	PIN	-	50
10459062	10459076	24	7/16	PIN	-	75
10459063	10459065	12	7/16	PIN	-	85
10459068	10459065	12	7/16	PIN	-	85
10459071	10459076	24	7/16	PIN	-	75
10459072	10459064	24	7/16	PIN	-	50
10459073	10459067	12	1/4	PIN	-	85
10459074	10459065	12	7/16	PIN	-	85
10459075	10459077	12	7/16	PIN	-	75
10459132	10459065	12	7/16	PIN	-	85
10459136	10459077	12	7/16	PIN	-	75
10459137	10459064	24	7/16	PIN	-	50
10459148	10459076	24	7/16	PIN	-	75
10459162	10459161	12	1/4	-	#10	85
19010000	10459076	24	7/16	PIN	-	75
19010001	10459064	24	7/16	PIN	-	50
19010002	10459076	24	7/16	PIN	-	75
19010003	10459065	12	7/16	PIN	-	85
19010004	10459245	24	7/16	-	#10	50
19010005	10459066	12	7/16	-	#10	85
19010006	10459064	24	7/16	PIN	-	50
19010007	10459067	12	1/4	PIN	-	85
19010008	10459076	24	7/16	PIN	-	75
19010009	10459065	12	7/16	PIN	-	85
19010010	10459067	12	1/4	PIN	-	85
19010011	10459067	12	1/4	PIN	-	85
19010012	10459067	12	1/4	PIN	-	85
19010013	10459067	12	1/4	PIN	-	85
19010014	10459067	12	1/4	PIN	-	85
19010018	10459161	12	1/4	-	#10	85
19010019	10459065	12	7/16	PIN	-	85
19010020	10459064	24	7/16	PIN	-	50
19010024	10459076	24	7/16	PIN	-	75

AC DELCO CATALOG NUMBERS						
321-697	10459076	24	7/16	PIN	-	75
321-698	10459064	24	7/16	PIN	-	50

25SI & 26SI (cont.)

Part Number	Reman Number	Battery Volts	Term	R Term	I Term	Amps
AC DELCO CATALOG NUMBERS (CONT.)						
321-699	10459067	12	1/4	PIN	-	85
321-700	10459065	12	7/16	PIN	-	85
321-702	10459077	12	7/16	PIN	-	75
321-707	10459066	12	7/16	-	#10	85
321-726	10459161	12	1/4	-	#10	85
321-752	10459245	24	7/16	-	#10	50

CARGO PART NUMBERS

110416	10459065	12	7/16	PIN	-	85
110416	10459077	12	7/16	PIN	-	75
110591	10459064	24	7/16	PIN	-	50
110591	10459076	24	7/16	PIN	-	75
110591	10459077	12	7/16	PIN	-	75
111261	10459064	24	7/16	PIN	-	50

CUMMINS RECON PART NUMBERS

3603848RX	10459064	24	7/16	PIN	-	50
3603850RX	10459077	12	7/16	PIN	-	75
3604225RX	10459076	24	7/16	PIN	-	75
3604647RX	10459065	12	7/16	PIN	-	85
3675108RX	10459064	24	7/16	PIN	-	50
3675108RX	10459076	24	7/16	PIN	-	75
3675109RX	10459065	12	7/16	PIN	-	85
3675109RX	10459067	12	1/4	PIN	-	85
3675109RX	10459077	12	7/16	PIN	-	75
3675168RX	10459067	12	1/4	PIN	-	85

DDC CATALOG NUMBERS

R0459132	10459065	12	7/16	PIN	-	85
R0459136	10459077	12	7/16	PIN	-	75
R0459137	10459064	24	7/16	PIN	-	50
R0459148	10459076	24	7/16	PIN	-	75

DDC PART NUMBERS

10459132	10459065	12	7/16	PIN	-	85
10459136	10459077	12	7/16	PIN	-	75
10459137	10459064	24	7/16	PIN	-	50
10459148	10459076	24	7/16	PIN	-	75

DIXIE PART NUMBERS

A-1101	10459076	24	7/16	PIN	-	75
A-1193	10459245	24	7/16	-	#10	50
A-129	10459064	24	7/16	PIN	-	50

Part Number	Reman Number	Battery Volts	Term	R Term	I Term	Amps
DIXIE PART NUMBERS (CONT.)						
A-1296	10459064	24	7/16	PIN	-	50
A-1331	10459065	12	7/16	PIN	-	85
A-1331	10459067	12	1/4	PIN	-	85
A-1331	10459077	12	7/16	PIN	-	75

KOMATSU PART NUMBERS

ALT1005	10459077	12	7/16	PIN	-	75
ALT1006	10459064	24	7/16	PIN	-	50
ALT1007	10459076	24	7/16	PIN	-	75
ALT1017	10459076	24	7/16	PIN	-	75
ALT1018	10459067	12	1/4	PIN	-	85

MIDLAND PART NUMBERS

RA125002X	10459077	12	7/16	PIN	-	75
RA125003X	10459076	24	7/16	PIN	-	75
RA126001X	10459065	12	7/16	PIN	-	85
RA126002X	10459077	12	7/16	PIN	-	75
RA126003X	10459066	12	7/16	-	#10	85
RA126004X	10459067	12	1/4	PIN	-	85
RA126005X	10459064	24	7/16	PIN	-	50
RA126006X	10459076	24	7/16	PIN	-	75
RA126007X	10459161	12	1/4	-	#10	85

WILSON PART NUMBERS

90-01-3028	10459077	12	7/16	PIN	-	75
90-01-3030	10459064	24	7/16	PIN	-	50
90-01-3031	10459077	12	7/16	PIN	-	75
90-01-3099	10459076	24	7/16	PIN	-	75
90-01-3158	10459064	24	7/16	PIN	-	50
90-01-4077	10459065	12	7/16	PIN	-	85
90-01-4083	10459076	24	7/16	PIN	-	75
90-01-4148	10459065	12	7/16	PIN	-	85
90-01-4171	10459064	24	7/16	PIN	-	50
90-01-4172	10459076	24	7/16	PIN	-	75
90-01-4173	10459065	12	7/16	PIN	-	85
90-01-4173	10459067	12	1/4	PIN	-	85
90-01-4173	10459077	12	7/16	PIN	-	75
90-01-4174	10459067	12	1/4	PIN	-	85

REMANUFACTURED ALTERNATORS



27SI



Note:
 * positive polarity
 † extended shaft

Part Number	Reman Number	Type	Battery Volts	R Term	I Term	Amps
DELCO REMY REMANUFACTURED PART NUMBERS						
10459069	10459069	200	12	#12	PIN	80
10459238	10459238	200	12	#12	PIN	100
10459244	10459244	200	24	#12	PIN	65
10459452	10459452	202	24	#12	PIN	30
10463072	10463072	200	12	M6	PIN	80
10463073	10463073	200	12	M6	PIN	65
10463074	10463074*	200	12	M6	PIN	80
10463160	10463160†	205	12	#12	PIN	80
10463161	10463161†	205	12	#12	PIN	100
19020504	19020504	100	12	M6	-	100

Part Number	Reman Number	Type	Battery Volts	R Term	I Term	Amps
DELCO REMY O.E. PART NUMBERS						
1100072	10463073	200	12	M6	PIN	65
1100073	10463072	200	12	M6	PIN	80
1100075	10463074*	200	12	M6	PIN	80
1100076	10463074*	200	12	M6	PIN	80
1100080	10463072	200	12	M6	PIN	80
1100081	10463073	200	12	M6	PIN	65
1100082	10463074*	200	12	M6	PIN	80
1100083	10463074*	200	12	M6	PIN	80
1100084	10463073	200	12	M6	PIN	65
1100086	10463073	200	12	M6	PIN	65
1100088	10463074*	200	12	M6	PIN	80
1100089	10463072	200	12	M6	PIN	80
1100090	10463073	200	12	M6	PIN	65
1100091	10459238	200	12	#12	PIN	100
1100095	10463160†	205	12	#12	PIN	80
1100096	10463161†	205	12	#12	PIN	100
1100185	10463073	200	12	M6	PIN	65
1100188	10463073	200	12	M6	PIN	65
1100189	10463072	200	12	M6	PIN	80
1100211	10459244	200	24	#12	PIN	65
1100212	10463073	200	12	M6	PIN	65
1100213	10459452	202	24	#12	PIN	30
1100214	10463074*	200	12	M6	PIN	80
1100214	10463073	200	12	M6	PIN	65
1100216	10463161†	205	12	#12	PIN	100
1100274	10459238	200	12	#12	PIN	100
1101015	19020504	100	12	M6	-	100
1101016	19020504	100	12	M6	-	100
1101018	19020504	100	12	M6	-	100
1101019	19020504	100	12	M6	-	100
1101020	19020504	100	12	M6	-	100
1101021	19020504	100	12	M6	-	100
1101022	19020504	100	12	M6	-	100
1101023	19020504	100	12	M6	-	100
1101025	19020504	100	12	M6	-	100
1101026	19020504	100	12	M6	-	100
1101027	19020504	100	12	M6	-	100

Part Number	Reman Number	Type	Battery Volts	R Term	I Term	Amps
DELCO REMY O.E. PART NUMBERS (CONT.)						
1101028	19020504	100	12	M6	-	100
1101029	19020504	100	12	M6	-	100
1101030	19020504	100	12	M6	-	100
1101032	19020504	100	12	M6	-	100
1101033	19020504	100	12	M6	-	100
1101034	19020504	100	12	M6	-	100
1101035	19020504	100	12	M6	-	100
1100086	10463073	200	12	M6	PIN	65
1100088	10463074*	200	12	M6	PIN	80
1100091	10459238	200	12	#12	PIN	100
1100211	10459244	200	24	#12	PIN	65
1100214	10463074*	200	12	M6	PIN	80
1100274	10459238	200	12	#12	PIN	100
1101036	19020504	100	12	M6	-	100
1101043	19020504	100	12	M6	-	100
1101046	19020504	100	12	M6	-	100
1101047	19020504	100	12	M6	-	100
1101048	19020504	100	12	M6	-	100
1101049	19020504	100	12	M6	-	100
1101050	19020504	100	12	M6	-	100
1101058	19020504	100	12	M6	-	100
1101059	19020504	100	12	M6	-	100
1101061	19020504	100	12	M6	-	100
1101062	19020504	100	12	M6	-	100
1101063	19020504	100	12	M6	-	100
1101064	19020504	100	12	M6	-	100
1101073	19020504	100	12	M6	-	100
1101090	19020504	100	12	M6	-	100
1101103	10459069	200	12	#12	PIN	80
1101104	10463072	200	12	M6	PIN	80
1101105	10463073	200	12	M6	PIN	65
1101109	19020504	100	12	M6	-	100
1101178	19020504	100	12	M6	-	100
1101251	10463072	200	12	M6	PIN	80
1101288	10463072	200	12	M6	PIN	80
1101289	10463073	200	12	M6	PIN	65
1101450	10459069	200	12	#12	PIN	80
1102553	10463072	200	12	M6	PIN	80
1105460	10463073	200	12	M6	PIN	65
1105461	10463074*	200	12	M6	PIN	80
1105463	10463073	200	12	M6	PIN	65
1105464	10463073	200	12	M6	PIN	65
1105465	10463072	200	12	M6	PIN	80
1105466	10463074*	200	12	M6	PIN	80
1105469	10463072	200	12	M6	PIN	80
1105470	10463072	200	12	M6	PIN	80
1105471	10463074*	200	12	M6	PIN	80
1105472	10459238	200	12	#12	PIN	100
1105473	10459238	200	12	#12	PIN	100

Remanufactured Alternators

27SI (cont.)

Part Number	Reman Number	Type	Volts	Battery Term	R Term	I Term	Amps
DELCO REMY O.E. PART NUMBERS (CONT.)							
1105474	10459244	200	24	#12	PIN	-	65
1105475	10459244	200	24	#12	PIN	-	65
1105476	10459244	200	24	#12	PIN	-	65
1105477	10459452	202	24	#12	PIN	-	30
1105577	19020504	100	12	M6	-	-	100
1105578	19020504	100	12	M6	-	-	100
1985155	10463073	200	12	M6	PIN	-	65
10497177	10463072	200	12	M6	PIN	-	80

AC DELCO CATALOG NUMBERS

321-49	19020504	100	12	M6	-	-	100
321-136	19020504	100	12	M6	-	-	100
321-603	10463072	200	12	M6	PIN	-	80
321-604	10463074*	200	12	M6	PIN	-	80
321-605	10463073	200	12	M6	PIN	-	65
321-654	10459244	200	24	#12	PIN	-	65
321-669	10459069	200	12	#12	PIN	-	80
321-679	10463160†	205	12	#12	PIN	-	80
321-680	10463161†	205	12	#12	PIN	-	100
321-742	10463161†	205	12	#12	PIN	-	100
321-743	10459238	200	12	#12	PIN	-	100

CARGO PART NUMBERS

110234	10463161†	205	12	#12	PIN	-	100
110235	10459452	202	24	#12	PIN	-	30
110300	10459244	200	24	#12	PIN	-	65
110499	10463161†	205	12	#12	PIN	-	100

CUMMINS RECON PART NUMBERS

3603851RX	10463072	200	12	M6	PIN	-	80
3603851RX	10463073	200	12	M6	PIN	-	65
3603852RX	10463074*	200	12	M6	PIN	-	80
3603853RX	10459244	200	24	#12	PIN	-	65
3604659RX	10459238	200	12	#12	PIN	-	100
3604669RX	19020504	100	12	M6	-	-	100
3604678RX	10459069	200	12	#12	PIN	-	80

DDC CATALOG NUMBERS

R0459152	10463073	200	12	M6	PIN	-	65
R0459153	10459244	200	24	#12	PIN	-	65

DDC PART NUMBERS

10459152	10463073	200	12	M6	PIN	-	65
10459153	10459244	200	24	#12	PIN	-	65

Part Number	Reman Number	Type	Volts	Battery Term	R Term	I Term	Amps
DIXIE PART NUMBERS							
A-166	10463072	200	12	M6	PIN	-	80
A-166	10463073	200	12	M6	PIN	-	65
A-167	10463072	200	12	M6	PIN	-	80
A-173	10459244	200	24	#12	PIN	-	65
A-175	10463074*	200	12	M6	PIN	-	80
A-176	10459452	202	24	#12	PIN	-	30
A-177	19020504	100	12	M6	-	-	100
A-1100	19020504	100	12	M6	-	-	100
A-1160	10463161†	205	12	#12	PIN	-	100
A-1167	10459238	200	12	#12	PIN	-	100
A-1243	10459069	200	12	#12	PIN	-	80

KOMATSU PART NUMBER

ALT1009	10459244	200	24	#12	PIN	-	65
---------	----------	-----	----	-----	-----	---	----

MIDLAND PART NUMBERS

RA127000X	10463072	200	12	M6	PIN	-	80
RA127001X	10463074*	200	12	M6	PIN	-	80
RA127002X	10459244	200	24	#12	PIN	-	65
RA127003X	10459238	200	12	#12	PIN	-	100
RA127006X	10463161†	205	12	#12	PIN	-	100
RA127007X	10459069	200	12	#12	PIN	-	80
RA127010X	10463073	200	12	M6	PIN	-	65
RA127100X	19020504	100	12	M6	-	-	100
RA127101X	19020504	100	12	M6	-	-	100

WILSON PART NUMBERS

90-01-3070	19020504	100	12	M6	-	-	100
90-01-3071	10463072	200	12	M6	PIN	-	80
90-01-3071	10463073	200	12	M6	PIN	-	65
90-01-3086	10463074*	200	12	M6	PIN	-	80
90-01-3091	19020504	100	12	M6	-	-	100
90-01-3100	10459244	200	24	#12	PIN	-	65
90-01-3104	10459452	202	24	#12	PIN	-	30
90-01-3107	19020504	100	12	M6	-	-	100
90-01-3108	19020504	100	12	M6	-	-	100
90-01-3115	10463160†	205	12	#12	PIN	-	80
90-01-3116	10463161†	205	12	#12	PIN	-	100
90-01-3117	10459238	200	12	#12	PIN	-	100
90-01-3176	10459069	200	12	#12	PIN	-	80

REMANUFACTURED ALTERNATORS



30SI

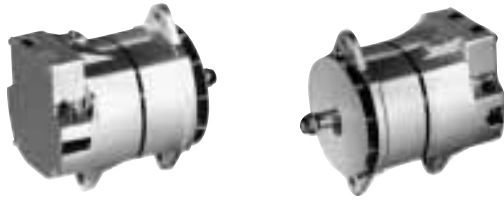

Note:
 * positive polarity
 ** transformer rectifier

Remanufactured Alternators

Part Number	Reman Number	Battery Volts	Term	R Term	I Term	Amps
DELCO REMY REMANUFACTURED PART NUMBERS						
1117746	1117746	24	1/4	1/4	-	60
10459004	10459004	12	1/4	PIN	-	90
10459008	10459008	12	1/4	PIN	-	105
10459009	10459009**	12	1/4	PIN	-	90
10459010	10459010**	12	1/4	PIN	-	90
10459016	10459016*	12	1/4	PIN	-	90
10459057	10459057	24	1/4	PIN	-	75
10459079	10459079	12	1/4	-	#10	105
10459097	10459097	12	1/4	PIN	-	105
10459120	10459120	24	1/4	PIN	-	100
10459246	10459246	12	1/4	-	-	90
10459258	10459258	12	1/4	PIN	-	105
10459259	10459259	12	1/4	#10	-	105
10459325	10459325	32	1/4	-	-	60
10459368	10459368**	12	1/4	PIN	-	105

Part Number	Reman Number	Battery Volts	Term	R Term	I Term	Amps
DELCO REMY O.E. PART NUMBERS						
1117067	10459009**	12	1/4	PIN	-	90
1117068	10459009**	12	1/4	PIN	-	90
1117481	10459009**	12	1/4	PIN	-	90
1117482	10459010**	12	1/4	PIN	-	90
1117483	10459009**	12	1/4	PIN	-	90
1117484	10459009**	12	1/4	PIN	-	90
1117485	10459009**	12	1/4	PIN	-	90
1117648	1117746	24	1/4	1/4	-	60
1117732	10459008	12	1/4	PIN	-	105
1117733	10459325	32	1/4	-	-	60
1117734	1117746	24	1/4	1/4	-	60
1117735	10459016*	12	1/4	PIN	-	90
1117736	10459008	12	1/4	PIN	-	105
1117738	10459246	12	1/4	-	-	90
1117753	10459246	12	1/4	-	-	90
1117754	10459246	12	1/4	-	-	90
1117772	1117746	24	1/4	1/4	-	60
1117800	10459008	12	1/4	PIN	-	105
1117801	10459008	12	1/4	PIN	-	105
1117803	10459008	12	1/4	PIN	-	105
1117804	10459008	12	1/4	PIN	-	105
1117805	10459057	24	1/4	PIN	-	75
1117806	10459259	12	1/4	#10	-	105
1117807	10459368**	12	1/4	PIN	-	105
1117808	10459008	12	1/4	PIN	-	105
1117809	10459258	12	1/4	PIN	-	105
1117811	10459008	12	1/4	PIN	-	105
1117812	10459008	12	1/4	PIN	-	105
1117813	10459008	12	1/4	PIN	-	105
1117814	10459009**	12	1/4	PIN	-	90
1117815	10459004	12	1/4	PIN	-	90
1117816	10459008	12	1/4	PIN	-	105
1117817	10459120	24	1/4	PIN	-	100

Part Number	Reman Number	Battery Volts	Term	R Term	I Term	Amps
DELCO REMY O.E. PART NUMBERS (CONT.)						
1117818	10459079	12	1/4	-	#10	105
1117820	10459097	12	1/4	PIN	-	105
1117822	10459259	12	1/4	#10	-	105
1117823	10459259	12	1/4	#10	-	105
1117826	1117746	24	1/4	1/4	-	60
1117830	10459097	12	1/4	PIN	-	105
1117831	10459057	24	1/4	PIN	-	75
10459000	10459008	12	1/4	PIN	-	105
10459001	10459008	12	1/4	PIN	-	105
10459138	10459079	12	1/4	-	#10	105
10459149	10459009**	12	1/4	PIN	-	90
10459150	10459258	12	1/4	PIN	-	105
10459202	10459008	12	1/4	PIN	-	105
10459237	10459057	24	1/4	PIN	-	75
10459369	10459368**	12	1/4	PIN	-	105
19011181	10459010**	12	1/4	PIN	-	90

Part Number	Reman Number	Battery Volts	Term	R Term	I Term	Amps
AC DELCO CATALOG NUMBERS						
321-641	10459004	12	1/4	PIN	-	90
321-642	10459016*	12	1/4	PIN	-	90
321-643	10459009**	12	1/4	PIN	-	90
321-644	10459010**	12	1/4	PIN	-	90
321-645	1117746	24	1/4	1/4	-	60
321-646	10459325	32	1/4	-	-	60
321-670	10459008	12	1/4	PIN	-	105
321-671	10459057	24	1/4	PIN	-	75
321-696	10459097	12	1/4	PIN	-	105
321-708	10459079	12	1/4	-	#10	105
321-710	10459120	24	1/4	PIN	-	100
321-751	10459246	12	1/4	-	-	90
321-754	10459258	12	1/4	PIN	-	105
321-755	10459259	12	1/4	#10	-	105

Part Number	Reman Number	Battery Volts	Term	R Term	I Term	Amps
CUMMINS RECON PART NUMBERS						
3603854RX	10459009**	12	1/4	PIN	-	90
3603877RX	10459004	12	1/4	PIN	-	90
3603877RX	10459008	12	1/4	PIN	-	105
3604652RX	10459008	12	1/4	PIN	-	105
3604652RX	10459097	12	1/4	PIN	-	105
3604652RX	10459258	12	1/4	PIN	-	105
3604679RX	10459325	32	1/4	-	-	60
3604685RX	1117746	24	1/4	1/4	-	60
3604685RX	10459016*	12	1/4	PIN	-	90
3604685RX	10459057	24	1/4	PIN	-	75
3675103RX	10459057	24	1/4	PIN	-	75

Part Number	Reman Number	Battery Volts	Term	R Term	I Term	Amps
DDC CATALOG NUMBERS						
R0459108	10459008	12	1/4	PIN	-	105
R0459138	10459079	12	1/4	-	#10	105
R0459149	10459009**	12	1/4	PIN	-	90

30SI (cont.)

Part Number	Reman Number	Battery Volts	Term	R Term	I Term	Amps
DDC CATALOG NUMBERS (CONT.)						
R0459150	10459258	12	1/4	PIN	-	105
R0459151	1117746	24	1/4	1/4	-	60
R0459207	10459120	24	1/4	PIN	-	100
R0459368	10459368**	12	1/4	PIN	-	105

Part Number	Reman Number	Battery Volts	Term	R Term	I Term	Amps
DDC PART NUMBERS						
10459108	10459008	12	1/4	PIN	-	105
10459138	10459079	12	1/4	-	#10	105
10459149	10459009**	12	1/4	PIN	-	90
10459150	10459258	12	1/4	PIN	-	105
10459151	1117746	24	1/4	1/4	-	60
10459207	10459120	24	1/4	PIN	-	100
10459368	10459368**	12	1/4	PIN	-	105

Part Number	Reman Number	Battery Volts	Term	R Term	I Term	Amps
DIXIE PART NUMBERS						
A-168	10459016*	12	1/4	PIN	-	90
A-190	10459010**	12	1/4	PIN	-	90
A-1102	10459325	32	1/4	-	-	60
A-1103	1117746	24	1/4	1/4	-	60
A-1329	10459009**	12	1/4	PIN	-	90
A-1329	10459368**	12	1/4	PIN	-	105
A-1332	10459004	12	1/4	PIN	-	90
A-1332	10459008	12	1/4	PIN	-	105
A-1332	10459258	12	1/4	PIN	-	105
A-1339	10459057	24	1/4	PIN	-	75

Part Number	Reman Number	Battery Volts	Term	R Term	I Term	Amps
KOMATSU PART NUMBERS						
ALT1010	10459057	24	1/4	PIN	-	75
ALT1011	10459120	24	1/4	PIN	-	100

Part Number	Reman Number	Battery Volts	Term	R Term	I Term	Amps
MIDLAND PART NUMBERS						
RA130000X	10459009**	12	1/4	PIN	-	90
RA130001X	10459004	12	1/4	PIN	-	105
RA130002X	10459008	12	1/4	PIN	-	105
RA130003X	10459010**	12	1/4	PIN	-	90
RA130006X	10459079	12	1/4	-	#10	105
RA130007X	10459097	12	1/4	PIN	-	105
RA130008X	10459057	24	1/4	PIN	-	75
RA130009X	10459016*	12	1/4	PIN	-	90

Part Number	Reman Number	Battery Volts	Term	R Term	I Term	Amps
WILSON PART NUMBERS						
90-01-3005	10459246	12	1/4	-	-	90
90-01-3093	10459009**	12	1/4	PIN	-	90
90-01-3094	10459004	12	1/4	PIN	-	90
90-01-3094	10459008	12	1/4	PIN	-	105
90-01-3095	10459016*	12	1/4	PIN	-	90
90-01-3096	10459010**	12	1/4	PIN	-	90
90-01-3098	10459325	32	1/4	-	-	60
90-01-4057	10459008	12	1/4	PIN	-	105
90-01-4057	10459079	12	1/4	-	#10	105
90-01-4057	10459097	12	1/4	PIN	-	105
90-01-4057	10459258	12	1/4	PIN	-	105
90-01-4081	10459368**	12	1/4	PIN	-	105
90-01-4154	10459057	24	1/4	PIN	-	75

33SI

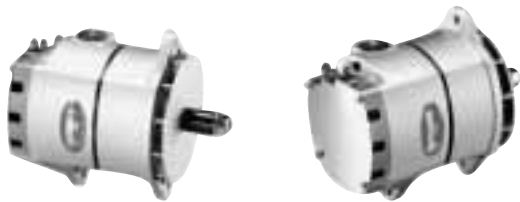

Note:
 * transformer rectifier
 **remote sense, temp compensation

Part Number	Reman Number	Battery Volts	Term	R Term	I Term	Amps
DELCO REMY REMANUFACTURED PART NUMBERS						
10459141	10459141	12	1/4	#10	#10	135
10459142	10459142	12	1/4	PIN	#10	135
10459143	10459143	12	1/4	PIN	#10	110
10459144	10459144	12	1/4	#10	#10	110
10459196	10459196	24	1/4	PIN	#10	100
10459311	10459311	24	1/4	PIN	#10	75
10459314	10459314*	12	1/4	PIN	#10	110
10459450	10459450**	12	1/4	#10	#10	135
10459473	10459473	12	1/4	PIN	#10	110

Part Number	Reman Number	Battery Volts	Term	R Term	I Term	Amps
DELCO REMY O.E. PART NUMBERS						
10459194	10459144	12	1/4	#10	#10	110
10459195	10459141	12	1/4	#10	#10	135
10459450	10459314*	12	1/4	PIN	#10	110

Part Number	Reman Number	Battery Volts	Term	R Term	I Term	Amps
DELCO REMY O.E. PART NUMBERS (CONT.)						
19011150	10459144	12	1/4	#10	#10	110
19011151	10459143	12	1/4	PIN	#10	110
19011152	10459142	12	1/4	PIN	#10	135
19011153	10459196	24	1/4	PIN	#10	100
19011154	10459143	12	1/4	PIN	#10	110
19011155	10459141	12	1/4	#10	#10	135
19011156	10459142	12	1/4	PIN	#10	135
19011158	10459143	12	1/4	PIN	#10	110
19011159	10459142	12	1/4	PIN	#10	135
19011160	10459143	12	1/4	PIN	#10	110
19011161	10459142	12	1/4	PIN	#10	135
19011162	10459143	12	1/4	PIN	#10	110
19011163	10459142	12	1/4	PIN	#10	135
19011164	10459473	12	1/4	PIN	#10	110

REMANUFACTURED ALTERNATORS



33SI (cont.)

Part Number	Reman Number	Battery Volts	Term	R Term	I Term	Amps
DELCO REMY O.E. PART NUMBERS (CONT.)						
19011173	10459142	12	1/4	PIN	#10	135
19011174	10459143	12	1/4	PIN	#10	110
19011175	10459196	24	1/4	PIN	#10	100
19011192	10459311	24	1/4	PIN	#10	75
19011193	10459314*	12	1/4	PIN	#10	110
19011200	10459450**	12	1/4	#10	#10	135
19011211	10459144	12	1/4	#10	#10	110
19011212	10459141	12	1/4	#10	#10	135

AC DELCO CATALOG NUMBERS

321-731	10459141	12	1/4	#10	#10	135
321-732	10459142	12	1/4	PIN	#10	135
321-733	10459143	12	1/4	PIN	#10	110
321-734	10459144	12	1/4	#10	#10	110
321-748	10459196	24	1/4	PIN	#10	100
321-769	10459311	24	1/4	PIN	#10	75

CUMMINS RECON PART NUMBERS

3675215RX	10459473	12	1/4	PIN	#10	110
3675233RX	10459142	12	1/4	PIN	#10	135
3675236RX	10459143	12	1/4	PIN	#10	110

DDC CATALOG NUMBERS

R0459194	10459144	12	1/4	#10	#10	110
R0459195	10459141	12	1/4	#10	#10	135
R0459196	10459196	24	1/4	PIN	#10	100

Part Number	Reman Number	Battery Volts	Term	R Term	I Term	Amps
DDC PART NUMBERS						
10459194	10459144	12	1/4	#10	#10	110
10459195	10459141	12	1/4	#10	#10	135
10459196	10459196	24	1/4	PIN	#10	100

DIXIE PART NUMBERS

A-1455	10459143	12	1/4	PIN	#10	110
A-1455	10459144	12	1/4	#10	#10	110
A-1456	10459141	12	1/4	#10	#10	135
A-1456	10459142	12	1/4	PIN	#10	135
A-1457	10459196	24	1/4	PIN	#10	100

MIDLAND PART NUMBERS

RA133001X	10459143	12	1/4	PIN	#10	110
RA133002X	10459144	12	1/4	#10	#10	110
RA133003X	10459142	12	1/4	PIN	#10	135
RA133004X	10459141	12	1/4	#10	#10	135

WILSON PART NUMBERS

90-01-4260	10459143	12	1/4	PIN	#10	110
90-01-4260	10459144	12	1/4	#10	#10	110
90-01-4262	10459141	12	1/4	#10	#10	135
90-01-4262	10459142	12	1/4	PIN	#10	135

34SI QUAD Mount



*Note: remote sense

Part Number	Reman Number	Battery Volts	Term	R Term	I Term	Amps
DELCO REMY REMANUFACTURED PART NUMBERS						
10459145	10459145	12	1/4	#10	#10	110
10459199	10459199	24	1/4	PIN	#10	100
10459206	10459206	12	1/4	#10	#10	135
10459287	10459287*	12	1/4	#10	#10	135
10459353	10459353	24	1/4	PIN	#10	75
10459359	10459359	24	1/4	PIN	#10	100
10459451	10459451*	12	1/4	#10	#10	135

DELCO REMY O.E. PART NUMBERS

10459197	10459145	12	1/4	#10	#10	110
10459198	10459206	12	1/4	#10	#10	135
10461226	10459206	12	1/4	#10	#10	135
19011157	10459145	12	1/4	#10	#10	110
19011167	10459206	12	1/4	#10	#10	135
19011168	10459199	24	1/4	PIN	#10	100
19011169	10459145	12	1/4	#10	#10	110
19011170	10459206	12	1/4	#10	#10	135
19011179	10459287*	12	1/4	#10	#10	135

Part Number	Reman Number	Battery Volts	Term	R Term	I Term	Amps
DELCO REMY O.E. PART NUMBERS (CONT.)						
19011189	10459353	24	1/4	PIN	#10	75
19011191	10459353	24	1/4	PIN	#10	75
19011195	10459353	24	1/4	PIN	#10	75
19011201	10459451*	12	1/4	#10	#10	135
19011205	10459353	24	1/4	PIN	#10	75
19011208	10459199	24	1/4	PIN	#10	100
19011214	10459206	12	1/4	#10	#10	135

AC DELCO CATALOG NUMBERS

321-735	10459145	12	1/4	#10	#10	110
321-741	10459206	12	1/4	#10	#10	135
321-757	10459287*	12	1/4	#10	#10	135

DDC CATALOG NUMBERS

R0459197	10459145	12	1/4	#10	#10	110
R0459198	10459206	12	1/4	#10	#10	135
R0459199	10459199	24	1/4	PIN	#10	100
R0459287	10459287*	12	1/4	#10	#10	135

34SI QUAD Mount (cont.)

Part Number	Reman Number	Battery Volts	Battery Term	R Term	I Term	Amps
DDC PART NUMBERS						
10459197	10459145	12	1/4	#10	#10	110
10459198	10459206	12	1/4	#10	#10	135
10459199	10459199	24	1/4	PIN	#10	100
10459287	10459287*	12	1/4	#10	#10	135

Part Number	Reman Number	Battery Volts	Battery Term	R Term	I Term	Amps
MIDLAND PART NUMBERS						
RA134001X	10459145	12	1/4	#10	#10	110
RA134002X	10459206	12	1/4	#10	#10	135

Part Number	Reman Number	Battery Volts	Battery Term	R Term	I Term	Amps
WILSON PART NUMBERS						
90-01-4267	10459145	12	1/4	#10	#10	110
90-01-4271	10459145	12	1/4	#10	#10	110
90-01-4272	10459206	12	1/4	#10	#10	135

34SI PAD Mount



*Note: remote sense

Part Number	Reman Number	Battery Volts	Battery Term	R Term	I Term	Amps
DELCO REMY REMANUFACTURED PART NUMBERS						
10459278	10459278	12	1/4	#10	#10	135
10459279	10459279	12	1/4	#10	#10	110
10459288	10459288*	12	1/4	#10	#10	135
10459355	10459355	24	1/4	PIN	#10	75
10459449	10459449*	12	1/4	#10	#10	135

Part Number	Reman Number	Battery Volts	Battery Term	R Term	I Term	Amps
DELCO REMY O.E. PART NUMBERS						
19011176	10459279	12	1/4	#10	#10	110
19011177	10459278	12	1/4	#10	#10	135
19011187	10459288*	12	1/4	#10	#10	135
19011194	10459355	24	1/4	PIN	#10	75
19011202	10459449*	12	1/4	#10	#10	135
19011216	10459278	12	1/4	#10	#10	135

Part Number	Reman Number	Battery Volts	Battery Term	R Term	I Term	Amps
AC DELCO CATALOG NUMBERS						
321-758	10459288*	12	1/4	#10	#10	135
321-763	10459279	12	1/4	#10	#10	110
321-764	10459278	12	1/4	#10	#10	135

Part Number	Reman Number	Battery Volts	Battery Term	R Term	I Term	Amps
DDC CATALOG NUMBERS						
R0459278	10459278	12	1/4	#10	#10	135
R0459279	10459279	12	1/4	#10	#10	110
R0459288	10459288*	12	1/4	#10	#10	135
R0459328	10459279	12	1/4	#10	#10	110
R0459330	10459288*	12	1/4	#10	#10	135C

Part Number	Reman Number	Battery Volts	Battery Term	R Term	I Term	Amps
DDC PART NUMBERS						
10459278	10459278	12	1/4	#10	#10	135
10459279	10459279	12	1/4	#10	#10	110
10459288	10459288*	12	1/4	#10	#10	135
10459328	10459279	12	1/4	#10	#10	110
10459330	10459288*	12	1/4	#10	#10	135

35SI



*Note: remote sense

Part Number	Reman Number	Battery Volts	Battery Term	R Term	I Term	Amps
DELCO REMY REMANUFACTURED PART NUMBERS						
8700000	8700000	12	1/4	#10	#10	135
8700005	8700005	12	1/4	#10	#10	135
8700023	8700023	12	1/4	#10	#10	110
8700024	8700024	12	1/4	PIN	#10	110
8700026	8700026	12	1/4	#10	#10	135

Part Number	Reman Number	Battery Volts	Battery Term	R Term	I Term	Amps
DELCO REMY REMANUFACTURED PART NUMBERS (CONT.)						
8700028	8700028	12	1/4	#10	#10	110
10459606	10459606	12	1/4	PIN	#10	110
10459609	10459609	12	1/4	P/T	#10	135
10459612	10459612	12	1/4	#10	#10	135

REMANUFACTURED ALTERNATORS



35SI (cont.)

Part Number	Reman Number	Volts	Battery Term	R Term	I Term	Amps
DELCO REMY O.E. PART NUMBERS						
19011227	8700023	12	1/4	#10	#10	110
19011231	8700024	12	1/4	PIN	#10	110
19011228	10459606	12	1/4	PIN	#10	110
19011229	10459609	12	1/4	P/T	#10	135

Part Number	Reman Number	Volts	Battery Term	R Term	I Term	Amps
DELCO REMY O.E. PART NUMBERS (CONT.)						
19011232	8700000	12	1/4	#10	#10	135
19011248	8700026	12	1/4	#10	#10	135
19011260	10459612*	12	1/4	#10	#10	135
19011263	8700028	12	1/4	#10	#10	110
19011264	8700005	12	1/4	#10	#10	135

35SI QUAD Mount



*Note: remote sense

Part Number	Reman Number	Volts	Battery Term	R Term	I Term	Amps
DELCO REMY REMANUFACTURED PART NUMBERS						
8700003	8700003	12	1/4	#10	#10	135
8700006	8700006	12	1/4	#10	#10	135
8700025	8700025	12	1/4	PIN	#10	110
8700027	8700027	12	1/4	#10	#10	135
8700029	8700029	12	1/4	#10	#10	110
10459607	10459607	12	1/4	#10	#10	110
10459610	10459610	12	1/4	#10	#10	135
10459613	10459613	12	1/4	#10	#10	135

Part Number	Reman Number	Volts	Battery Term	R Term	I Term	Amps
DELCO REMY O.E. PART NUMBERS						
19011234	10459607	12	1/4	#10	#10	110
19011244	10459610	12	1/4	#10	#10	135
19011246	8700025	12	1/4	PIN	#10	110
19011249	8700027	12	1/4	#10	#10	135
19011255	8700003*	12	1/4	#10	#10	135
19011261	10459613*	12	1/4	#10	#10	135
19011265	8700029	12	1/4	#10	#10	110
19011266	8700006	12	1/4	#10	#10	135

35SI PAD Mount



*Note: remote sense

Part Number	Reman Number	Volts	Battery Term	R Term	I Term	Amps
DELCO REMY REMANUFACTURED PART NUMBERS						
8700001	8700001	12	1/4	#10	#10	110
8700002	8700002	12	1/4	#10	#10	135
8700004	8700004	12	1/4	#10	#10	135
8700007	8700002	12	1/4	#10	#10	135
8700030	8700030	12	1/4	#10	#10	110
10459608	10459608	12	1/4	#10	#10	110
10459611	10459611	12	1/4	#10	#10	135
10459614	10459614	12	1/4	#10	#10	135

Part Number	Reman Number	Volts	Battery Term	R Term	I Term	Amps
DELCO REMY O.E. PART NUMBERS						
19011252	10459608	12	1/4	#10	#10	110
19011253	10459611	12	1/4	#10	#10	135
19011258	8700004*	12	1/4	#10	#10	135
19011262	10459614*	12	1/4	#10	#10	135
19011267	8700030	12	1/4	#10	#10	110
19011268	8700007	12	1/4	#10	#10	135
19011272	8700001	12	1/4	#10	#10	110
19011273	8700002	12	1/4	#10	#10	135

35SI HP



J180 Mount



QUAD Mount



PAD Mount

Part Number	Reman Number	Battery Volts	Battery Term	R Term	I Term	Amps	Mtg
-------------	--------------	---------------	--------------	--------	--------	------	-----

DELCO REMY REMANUFACTURED PART NUMBERS

8700016	8700016	12	1/4	#10	#10	140	J180
8700017	8700017	12	1/4	#10	#10	140	QUAD
8700018	8700018	12	1/4	#10	#10	140	PAD

Part Number	Reman Number	Battery Volts	Battery Term	R Term	I Term	Amps	Mtg
-------------	--------------	---------------	--------------	--------	--------	------	-----

DELCO REMY O.E. PART NUMBERS

8600064	8700016	12	1/4	#10	#10	140	J180
8600065	8700017	12	1/4	#10	#10	140	QUAD
8600066	8700018	12	1/4	#10	#10	140	PAD

50DN Belt Drive

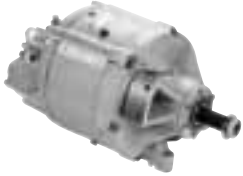

*Note: partially assembled reman. unit rectifier/stator rotor/drive end (each unit ready for assembly)

Part Number	Reman Number	Battery Volts	Battery Term	R Term	I Term	Amps
-------------	--------------	---------------	--------------	--------	--------	------

DELCO REMY REMANUFACTURED PART NUMBERS

10459123	10459123	24	1/2	1/4	-	270
10459250	10459250*	24	1/2	1/4	-	270
10459299	10459299	12	1/2	1/4	-	300

DELCO REMY O.E. PART NUMBERS

1117167	10459123	24	1/2	1/4	-	270
1117707	10459123	24	1/2	1/4	-	270
1117708	10459123	24	1/2	1/4	-	270
1117739	10459123	24	1/2	1/4	-	270
1117799	10459123	24	1/2	1/4	-	270
1117852	10459123	24	1/2	1/4	-	270
1117853	10459123	24	1/2	1/4	-	270
1117860	10459299	12	1/2	1/4	-	300
1117863	10459123	24	1/2	1/4	-	270
1117864	10459123	24	1/2	1/4	-	270
1117877	10459299	12	1/2	1/4	-	300
1117878	10459123	24	1/2	1/4	-	270
1117879	10459123	24	1/2	1/4	-	270

Part Number	Reman Number	Battery Volts	Battery Term	R Term	I Term	Amps
-------------	--------------	---------------	--------------	--------	--------	------

DELCO REMY O.E. PART NUMBERS (CONT.)

10456498	10459299	12	1/2	1/4	-	300
10459033	10459123	24	1/2	1/4	-	270
10459113	10459123	24	1/2	1/4	-	270
10459127	10459123	24	1/2	1/4	-	270
10459130	10459123	24	1/2	1/4	-	270

AC DELCO CATALOG NUMBERS

321-695	10459299	12	1/2	1/4	-	300
321-713	10459123	24	1/2	1/4	-	270
321-713	10459250*	24	1/2	1/4	-	270

DDC CATALOG NUMBERS

R0459114	10459299	12	1/2	1/4	-	300
R0459130	10459123	24	1/2	1/4	-	270

DDC PART NUMBERS

10459114	10459299	12	1/2	1/4	-	300
10459130	10459123	24	1/2	1/4	-	270

50DN Gear Drive



Part Number	Reman Number	Battery Volts	Battery Term	R Term	I Term	Amps
-------------	--------------	---------------	--------------	--------	--------	------

DELCO REMY REMANUFACTURED PART NUMBERS

10459121	10459121	24	1/2	1/4	-	270
10459122	10459122	24	1/2	1/4	-	270

Part Number	Reman Number	Battery Volts	Battery Term	R Term	I Term	Amps
-------------	--------------	---------------	--------------	--------	--------	------

DELCO REMY REMANUFACTURED PART NUMBERS (CONT.)

10459124	10459124	24	1/2	1/4	-	240
10459297	10459297	12	1/2	1/4	-	300
10459298	10459298	12	1/2	1/4	-	300

REMANUFACTURED ALTERNATORS



50DN Gear Drive (cont.)

Part Number	Reman Number	Battery Volts	Term	R Term	I Term	Amps
DELCO REMY O.E. PART NUMBERS						
1117689	10459124	24	1/2	1/4	-	240
1117690	10459297	12	1/2	1/4	-	300
1117692	10459124	24	1/2	1/4	-	240
1117695	10459124	24	1/2	1/4	-	240
1117698	10459124	24	1/2	1/4	-	240
1117700	10459124	24	1/2	1/4	-	240
1117792	10459124	24	1/2	1/4	-	240
1117794	10459124	24	1/2	1/4	-	240
1117854	10459298	12	1/2	1/4	-	300
1117855	10459297	12	1/2	1/4	-	300
1117861	10459121	24	1/2	1/4	-	270
1117862	10459122	24	1/2	1/4	-	270
1117866	10459121	24	1/2	1/4	-	270
1117867	10459122	24	1/2	1/4	-	270
10456496	10459298	12	1/2	1/4	-	300
10456497	10459297	12	1/2	1/4	-	300
10459060	10459124	24	1/2	1/4	-	240
10459125	10459121	24	1/2	1/4	-	270
10459126	10459122	24	1/2	1/4	-	270
10459128	10459124	24	1/2	1/4	-	240
10459129	10459121	24	1/2	1/4	-	270
10459131	10459122	24	1/2	1/4	-	270
10459235	10459121	24	1/2	1/4	-	270

Part Number	Reman Number	Battery Volts	Term	R Term	I Term	Amps
AC DELCO CATALOG NUMBERS						
321-693	10459298	12	1/2	1/4	-	300
321-694	10459297	12	1/2	1/4	-	300
321-711	10459121	24	1/2	1/4	-	270
321-712	10459122	24	1/2	1/4	-	270
321-714	10459124	24	1/2	1/4	-	240
321-746	10459297	12	1/2	1/4	-	300

DDC CATALOG NUMBERS						
R0459129	10459121	24	1/2	1/4	-	270
R0459131	10459122	24	1/2	1/4	-	270

DDC PART NUMBERS						
10459129	10459121	24	1/2	1/4	-	270
10459131	10459122	24	1/2	1/4	-	270

DIXIE PART NUMBERS						
A-1901	10459298	12	1/2	1/4	-	300
A-1911	10459124	24	1/2	1/4	-	240
A-1917	10459121	24	1/2	1/4	-	270

50VR



Note:
 *service package hardware included
 *50VR replaces 50RD series

Part Number	Reman Number	Volts
SERVICE PACKAGES		
10503805	10503805	24
10503806	10503806	24
10503807	10503807	12

Part Number	Reman Number	Volts
DELCO REMY O.E. PART NUMBERS		
19020411	10503805	24
19020412	10503806	24
19020413	10503807	12

Delco Remy Generator



(example 10DN)

Part Number	Reman Number	Volts	Amps
DELCO REMY REMANUFACTURED PART NUMBERS			
10459572	10459572	12	42
10459574	10459574	24	8
10459575	10459575	12	25
10459576	10459576	12	20
10459577	10459577	12	20

Part Number	Reman Number	Volts	Amps
DELCO REMY REMANUFACTURED PART NUMBERS			
10459578	10459578	6	45
10459579	10459579	6	40
10459580	10459580	12	30
10459581	10459581	12	30

Delco Remy Generator (cont.)

Part Number	Reman Number	Volts	Amps
DELCO REMY O.E. PART NUMBERS			
1100014	10459579	6	40
1100015	10459579	6	40
1100018	10459579	6	40
1100019	10459579	6	40
1100020	10459579	6	40
1100023	10459579	6	40
1100024	10459579	6	40
1100028	10459579	6	40
1100030	10459579	6	40
1100031	10459579	6	40
1100305	10459576	12	20
1100310	10459580	12	30
1100312	10459580	12	30
1100314	10459576	12	20
1100315	10459576	12	20
1100316	10459576	12	20
1100318	10459580	12	30
1100320	10459580	12	30
1100324	10459580	12	30
1100326	10459580	12	30
1100328	10459577	12	20
1100332	10459576	12	20
1100334	10459576	12	20
1100335	10459576	12	20
1100336	10459580	12	30
1100342	10459576	12	20
1100348	10459576	12	20
1100349	10459576	12	20
1100350	10459576	12	20
1100352	10459576	12	20
1100353	10459577	12	20
1100354	10459576	12	20
1100355	10459576	12	20
1100359	10459577	12	20
1100360	10459576	12	20
1100362	10459577	12	20
1100363	10459576	12	20
1100364	10459576	12	20
1100365	10459575	12	25
1100369	10459576	12	20
1100371	10459576	12	20
1100374	10459575	12	25
1100379	10459577	12	20
1100380	10459575	12	25
1100384	10459576	12	20
1100388	10459576	12	20
1100390	10459575	12	25
1100394	10459576	12	20
1100396	10459576	12	20
1100397	10459576	12	20
1100398	10459575	12	25
1100400	10459576	12	20
1100401	10459576	12	20
1100407	10459575	12	25
1100408	10459576	12	20
1100409	10459576	12	20

Part Number	Reman Number	Volts	Amps
DELCO REMY O.E. PART NUMBERS (CONT.)			
1100410	10459576	12	20
1100413	10459575	12	25
1100417	10459576	12	20
1100419	10459575	12	25
1100426	10459576	12	20
1100430	10459576	12	20
1100431	10459576	12	20
1100432	10459577	12	20
1100434	10459577	12	20
1100435	10459577	12	20
1100439	10459577	12	20
1100436	10459576	12	20
1100441	10459576	12	20
1100444	10459575	12	25
1100450	10459575	12	25
1100735	10459572	12	42
1100773	10459572	12	42
1100821	10459572	12	42
1100822	10459572	12	42
1100887	10459572	12	42
1102001	10459581	12	30
1102002	10459581	12	30
1102003	10459581	12	30
1102005	10459581	12	30
1102006	10459581	12	30
1102007	10459581	12	30
1102008	10459581	12	30
1102010	10459581	12	30
1102011	10459581	12	30
1102014	10459581	12	30
1102021	10459581	12	30
1102022	10459581	12	30
1102023	10459581	12	30
1102028	10459581	12	30
1102030	10459581	12	30
1102034	10459581	12	30
1102044	10459581	12	30
1102051	10459581	12	30
1102053	10459581	12	30
1102059	10459581	12	30
1102061	10459581	12	30
1102063	10459581	12	30
1102065	10459581	12	30
1102066	10459581	12	30
1102067	10459581	12	30
1102069	10459581	12	30
1102072	10459581	12	30
1102081	10459581	12	30
1102082	10459581	12	30
1102085	10459581	12	30
1102086	10459581	12	30
1102087	10459581	12	30
1102088	10459581	12	30
1102092	10459581	12	30
1102095	10459581	12	30
1102096	10459581	12	30
1102098	10459581	12	30

REMANUFACTURED ALTERNATORS



Delco Remy Generator (cont.)

Part Number	Reman Number	Volts	Amps	Part Number	Reman Number	Volts	Amps
DELCO REMY O.E. PART NUMBERS (CONT.)				DELCO REMY O.E. PART NUMBERS (CONT.)			
1102099	10459581	12	30	1102664	10459578	6	45
1102109	10459581	12	30	1102665	10459578	6	45
1102113	10459581	12	30	1102667	10459578	6	45
1102120	10459581	12	30	1102671	10459578	6	45
1102125	10459581	12	30	1102672	10459578	6	45
1102128	10459581	12	30	1102673	10459578	6	45
1102130	10459581	12	30	1102674	10459578	6	45
1102134	10459581	12	30	1102678	10459578	6	45
1102140	10459581	12	30	1102680	10459578	6	45
1102144	10459581	12	30	1102682	10459578	6	45
1102151	10459581	12	30	1102691	10459578	6	45
1102158	10459581	12	30	1102700	10459578	6	45
1102163	10459581	12	30	1102701	10459578	6	45
1102164	10459581	12	30	1102705	10459578	6	45
1102166	10459581	12	30	1102706	10459578	6	45
1102168	10459581	12	30	1102707	10459578	6	45
1102170	10459581	12	30	1102710	10459578	6	45
1102171	10459581	12	30	1102711	10459578	6	45
1102172	10459581	12	30	1102713	10459578	6	45
1102173	10459581	12	30	1102714	10459578	6	45
1102183	10459581	12	30	1102717	10459578	6	45
1102190	10459581	12	30	1102719	10459578	6	45
1102191	10459581	12	30	1102721	10459578	6	45
1102199	10459581	12	30	1102728	10459578	6	45
1102200	10459581	12	30	1102729	10459578	6	45
1102203	10459581	12	30	1102731	10459578	6	45
1102209	10459581	12	30	1102732	10459578	6	45
1102210	10459581	12	30	1102733	10459578	6	45
1102222	10459581	12	30	1102737	10459578	6	45
1102224	10459581	12	30	1102740	10459578	6	45
1102240	10459581	12	30	1102742	10459578	6	45
1102241	10459581	12	30	1102744	10459578	6	45
1102248	10459581	12	30	1102745	10459578	6	45
1102251	10459581	12	30	1102747	10459578	6	45
1102258	10459581	12	30	1102749	10459578	6	45
1102263	10459581	12	30	1102750	10459578	6	45
1102264	10459581	12	30	1102752	10459578	6	45
1102265	10459581	12	30	1102753	10459578	6	45
1102266	10459581	12	30	1102757	10459578	6	45
1102268	10459581	12	30	1102761	10459578	6	45
1102269	10459581	12	30	1102769	10459578	6	45
1102273	10459581	12	30	1102770	10459578	6	45
1102274	10459581	12	30	1102773	10459578	6	45
1102282	10459581	12	30	1102775	10459578	6	45
1102291	10459581	12	30	1102778	10459578	6	45
1102303	10459581	12	30	1102780	10459578	6	45
1102304	10459581	12	30	1102781	10459578	6	45
1102308	10459581	12	30	1102782	10459578	6	45
1102316	10459581	12	30	1102785	10459578	6	45
1102319	10459581	12	30	1102786	10459578	6	45
1102328	10459581	12	30	1102787	10459578	6	45
1102332	10459581	12	30	1102789	10459578	6	45
1102955	10459581	12	30	1102793	10459578	6	45
1102976	10459581	12	30	1102794	10459578	6	45
1103011	10459581	12	30	1102797	10459578	6	45
1102653	10459578	6	45	1102801	10459578	6	45
1102657	10459578	6	45	1102803	10459578	6	45

Remanufactured Alternators

Delco Remy Generator (cont.)

Part Number	Reman Number	Volts	Amps
DELCO REMY O.E. PART NUMBERS (CONT.)			
1102806	10459578	6	45
1102808	10459578	6	45
1102810	10459578	6	45
1102820	10459578	6	45
1102831	10459578	6	45
1102832	10459578	6	45
1102955	10459581	12	30
1102976	10459581	12	30
1103011	10459581	12	30
1103026	10459574	24	8

DIXIE PART NUMBERS

A-158	10459572	12	42
G-109	10459581	12	30
G-118	10459579	6	40

Part Number	Reman Number	Volts	Amps
DIXIE PART NUMBERS (CONT.)			
G-119	10459578	6	45
G-121	10459580	12	30
TG-59	10459575	12	25
TG-59	10459576	12	20
TG-112	10459574	24	8
TG-126	10459577	12	20

WILSON PART NUMBERS

90-01-3056	10459572	12	42
92-01-3009	10459579	6	40
92-01-3010	10459578	6	45
92-01-3101	10459575	12	25
92-01-3103	10459574	24	8
92-01-3112	10459576	12	20
92-01-3115	10459577	12	20

Bosch K1 10459499

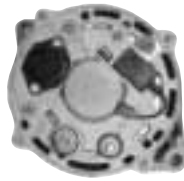

Part Number	Reman Number	Volts	Reg	Amps
DELCO REMY REMANUFACTURED PART NUMBER				
10459499	10459499	12	IR	95

BOSCH O.E. NUMBER

0-120-484-011	10459499	12	IR	95
---------------	----------	----	----	----

DIXIE PART NUMBER

A-6236	10459499	12	IR	95
--------	----------	----	----	----

Part Number	Reman Number	Volts	Reg	Amps
LESTER PART NUMBER				
12145	10459499	12	IR	95

WILSON PART NUMBER

90-15-6218	10459499	12	IR	95
------------	----------	----	----	----

Bosch K1 10459500



Part Number	Reman Number	Volts	Reg	Amps
DELCO REMY REMANUFACTURED PART NUMBER				
10459500	10459500	12	IR	65

BOSCH O.E. NUMBER

0-120-489-475	10459500	12	IR	65
---------------	----------	----	----	----

DIXIE PART NUMBER

A-6185	10459500	12	IR	65
--------	----------	----	----	----

Part Number	Reman Number	Volts	Reg	Amps
LESTER PART NUMBER				
12146	10459500	12	IR	65

WILSON PART NUMBER

90-15-6230	10459500	12	IR	65
------------	----------	----	----	----

REMANUFACTURED ALTERNATORS



Bosch K1 10459501



Part Number	Reman Number	Volts	Reg	Amps
DELCO REMY REMANUFACTURED PART NUMBER				
10459501	10459501	12	IR	45
BOSCH O.E. NUMBER				
0-120-489-481	10459501	12	IR	45
DIXIE PART NUMBER				
A-6216	10459501	12	IR	45

Part Number	Reman Number	Volts	Reg	Amps
LESTER PART NUMBER				
12147	10459501	12	IR	45
WILSON PART NUMBER				
90-15-6232	10459501	12	IR	45

Bosch K1 10459506



Part Number	Reman Number	Volts	Reg	Amps
DELCO REMY REMANUFACTURED PART NUMBER				
10459506	10459506	12	IR	65
BOSCH O.E. NUMBER				
9-120-060-040	10459506	12	IR	65

Part Number	Reman Number	Volts	Reg	Amps
LESTER PART NUMBER				
12158	10459506	12	IR	65
WILSON PART NUMBER				
90-15-6291	10459506	12	IR	65

Bosch K1 10459520



Part Number	Reman Number	Volts	Reg	Amps
DELCO REMY REMANUFACTURED PART NUMBER				
10459520	10459520	12	IR	65
BOSCH O.E. NUMBERS				
0-120-489-703	10459520	12	IR	65
0-120-489-704	10459520	12	IR	65
DIXIE PART NUMBER				
A-6108	10459520	12	IR	65

Part Number	Reman Number	Volts	Reg	Amps
LESTER PART NUMBER				
13193	10459520	12	IR	65
WILSON PART NUMBER				
90-15-6164	10459520	12	IR	65

Bosch K1 19020535



Part Number	Reman Number	Volts	Reg	Amps
DELCO REMY REMANUFACTURED PART NUMBER				
19020535	19020535	24	IR	45

BOSCH O.E. NUMBER

9-120-080-144	19020535	24	IR	45
---------------	-----------------	----	----	----

Part Number	Reman Number	Volts	Reg	Amps
LESTER PART NUMBER				
12295	19020535	24	IR	45

Bosch K1 19020536



Part Number	Reman Number	Volts	Reg	Amps
DELCO REMY REMANUFACTURED PART NUMBER				
19020536	19020536	24	IR	50

BOSCH O.E. NUMBER

0-120-488-206	19020536	24	IR	50
---------------	-----------------	----	----	----

DIXIE PART NUMBER

A-6238	19020536	24	IR	50
--------	-----------------	----	----	----

Part Number	Reman Number	Volts	Reg	Amps
LESTER PART NUMBER				
12148	19020536	24	IR	50

WILSON PART NUMBER

90-15-6237	19020536	24	IR	50
------------	-----------------	----	----	----

Bosch N1 10459498

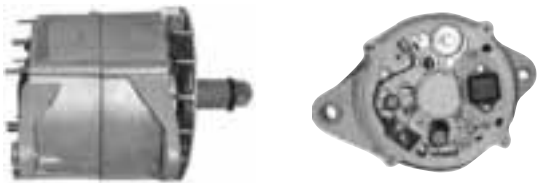

Part Number	Reman Number	Volts	Reg	Amps
DELCO REMY REMANUFACTURED PART NUMBER				
10459498	10459498	12	IR	110

BOSCH O.E. NUMBER

0-120-468-028	10459498	12	IR	110
---------------	-----------------	----	----	-----

DIXIE PART NUMBER

A-6226	10459498	12	IR	110
--------	-----------------	----	----	-----

Part Number	Reman Number	Volts	Reg	Amps
LESTER PART NUMBER				
12131	10459498	12	IR	110

WILSON PART NUMBER

90-15-6169	10459498	12	IR	110
------------	-----------------	----	----	-----

REMANUFACTURED ALTERNATORS



Bosch N1 10459503



Part Number	Reman Number	Volts	Reg	Amps
DELCO REMY REMANUFACTURED PART NUMBER				
10459503	10459503	24	IR	65
BOSCH O.E. NUMBER				
0-120-468-054	10459503	24	IR	65
DIXIE PART NUMBER				
A-6237	10459503	24	IR	65

Part Number	Reman Number	Volts	Reg	Amps
LESTER PART NUMBER				
12149	10459503	24	IR	65
WILSON PART NUMBER				
90-15-6236	10459503	24	IR	65

Bosch N1 10459510



Part Number	Reman Number	Volts	Reg	Amps
DELCO REMY REMANUFACTURED PART NUMBER				
10459510	10459510	12	IR	135
BOSCH O.E. NUMBER				
0-120-468-055	10459510	12	IR	135
DIXIE PART NUMBER				
A-6255	10459510	12	IR	135

Part Number	Reman Number	Volts	Reg	Amps
LESTER PART NUMBER				
12162	10459510	12	IR	135
WILSON PART NUMBER				
90-15-6231	10459510	12	IR	135

Bosch 10459505



Part Number	Reman Number	Volts	Reg	Amps
DELCO REMY REMANUFACTURED PART NUMBER				
10459505	10459505	24	IR	80
BOSCH O.E. NUMBER				
0-120-468-136	10459505	24	IR	80

Part Number	Reman Number	Volts	Reg	Amps
LESTER PART NUMBER				
12157	10459505	24	IR	80
WILSON PART NUMBER				
90-15-6298	10459505	24	IR	80

Bosch 10459508



Part Number	Reman Number	Volts	Reg	Amps
DELCO REMY REMANUFACTURED PART NUMBER				
10459508	10459508	12	IR	95

BOSCH O.E. NUMBER				
9-120-060-041	10459508	12	IR	95

Part Number	Reman Number	Volts	Reg	Amps
LESTER PART NUMBER				
12159	10459508	12	IR	95

WILSON PART NUMBER				
90-15-6295	10459508	12	IR	95

Bosch 10459511

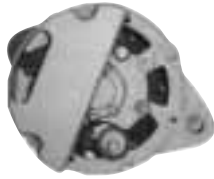

Part Number	Reman Number	Volts	Reg	Amps
DELCO REMY REMANUFACTURED PART NUMBER				
10459511	10459511	24	IR	50

BOSCH O.E. NUMBERS				
0-122-469-002	10459511	24	IR	50
0-122-469-004	10459511	24	IR	50

Part Number	Reman Number	Volts	Reg	Amps
LESTER PART NUMBER				
12166	10459511	24	IR	50

WILSON PART NUMBER				
90-15-6239	10459511	24	IR	50

Bosch 10459522



Part Number	Reman Number	Volts	Reg	Amps
DELCO REMY REMANUFACTURED PART NUMBER				
10459522	10459522	12	IR	33

BOSCH O.E. NUMBERS				
0-120-339-514	10459522	12	IR	33
0-120-339-531	10459522	12	IR	33

Part Number	Reman Number	Volts	Reg	Amps
DIXIE PART NUMBER				
A-6130	10459522	12	IR	33

LESTER PART NUMBER				
14949	10459522	12	IR	33

WILSON PART NUMBER				
90-15-6094	10459522	12	IR	33

REMANUFACTURED ALTERNATORS



Bosch 10459537



Part Number	Reman Number	Volts	Reg	Amps
DELCO REMY REMANUFACTURED PART NUMBER				
10459537	10459537	12	IR	132
BOSCH O.E. NUMBER				
6-004-MLO-004	10459537	12	IR	132
DIXIE PART NUMBER				
A-6323	10459537	12	IR	132

Part Number	Reman Number	Volts	Reg	Amps
LESTER PART NUMBER				
13881	10459537	12	IR	132
WILSON PART NUMBER				
90-15-6310	10459537	12	IR	132

Bosch 19020507



Part Number	Reman Number	Volts	Reg	Amps
DELCO REMY REMANUFACTURED PART NUMBER				
19020507	19020507	12	IR	37
BOSCH O.E. NUMBER				
9-120-060-027	19020507	12	IR	37
DIXIE PART NUMBER				
A-6250	19020507	12	IR	37
LESTER PART NUMBER				
12223	19020507	12	IR	37

Part Number	Reman Number	Volts	Reg	Amps
MIDLAND PART NUMBERS				
RA601000X	19020507	12	IR	37
THERMO KING PART NUMBERS				
44-8950	19020507	12	IR	37
44-9571	19020507	12	IR	37
WILSON PART NUMBER				
90-15-6233	19020507	12	IR	37

Bosch 19020508



Part Number	Reman Number	Volts	Reg	Amps
DELCO REMY REMANUFACTURED PART NUMBER				
19020508	19020508	12	IR	65
BOSCH O.E. NUMBER				
9-120-060-023	19020508	12	IR	65
DIXIE PART NUMBER				
A-6252	19020508	12	IR	65
LESTER PART NUMBER				
12224	19020508	12	IR	65

Part Number	Reman Number	Volts	Reg	Amps
MIDLAND PART NUMBERS				
RA6011010X	19020508	12	IR	65
THERMO KING PART NUMBER				
44-8525	19020508	12	IR	65
44-8949	19020508	12	IR	65
44-9572	19020508	12	IR	65
WILSON PART NUMBER				
90-15-6280	19020508	12	IR	65

Bosch 19020581



Part Number	Reman Number	Volts	Reg	Amps
DELCO REMY REMANUFACTURED PART NUMBER				
19020581	19020581	12	IR	65
BOSCH O.E. NUMBERS				
9-127-041-233	19020581	12	IR	65
9-127-041-241	19020581	12	IR	65
9-127-041-242	19020581	12	IR	65
CARRIER PART NUMBERS				
30-00393-00	19020581	12	IR	65
30-00393-02	19020581	12	IR	65

Part Number	Reman Number	Volts	Reg	Amps
DIXIE PART NUMBER				
A-6249	19020581	12	IR	65
LESTER PART NUMBER				
12225	19020581	12	IR	65
WILSON PART NUMBER				
90-15-6288	19020581	12	IR	65

Chrysler 10459518



Part Number	Reman Number	Volts	Reg	Amps
DELCO REMY REMANUFACTURED PART NUMBER				
10459518	10459518	12	ER	120
CHRYSLER O.E. NUMBERS				
4428082	10459518	12	ER	120
5227267	10459518	12	ER	120
5233160	10459518	12	ER	120
5233508	10459518	12	ER	120

Part Number	Reman Number	Volts	Reg	Amps
DIXIE PART NUMBER				
A-354	10459518	12	ER	120
LESTER PART NUMBER				
7552	10459518	12	ER	120
WILSON PART NUMBER				
90-03-2064	10459518	12	ER	120

Chrysler 10459583



Part Number	Reman Number	Volts	Reg	Amps
DELCO REMY REMANUFACTURED PART NUMBER				
10459583	10459583	12	ER	50
CHRYSLER O.E. NUMBER				
2095000	10459583	12	ER	50
DIXIE PART NUMBER				
A-303	10459583	12	ER	50

Part Number	Reman Number	Volts	Reg	Amps
LESTER PART NUMBER				
7007	10459583	12	ER	50
WILSON PART NUMBER				
90-03-2009	10459583	12	ER	50

REMANUFACTURED ALTERNATORS



Ford 3G 10459552

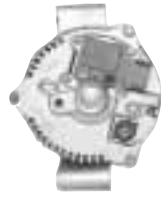

Part Number	Reman Number	Volts	Reg	Amps
DELCO REMY REMANUFACTURED PART NUMBER				
10459552	10459552	12	IR	130
FORD O.E. NUMBERS				
F37U10300AA	10459552	12	IR	130
F5UU10300AA	10459552	12	IR	130
F5UU10300BA	10459552	12	IR	130

Part Number	Reman Number	Volts	Reg	Amps
LESTER PART NUMBER				
7768	10459552	12	IR	130
WILSON PART NUMBER				
90-02-5065	10459552	12	IR	130

Ford 3G 10459553



Part Number	Reman Number	Volts	Reg	Amps
DELCO REMY REMANUFACTURED PART NUMBER				
10459553	10459553	12	IR	130
FORD O.E. NUMBERS				
F2PU10300DE	10459553	12	IR	130
F2UU10300DC	10459553	12	IR	130

Part Number	Reman Number	Volts	Reg	Amps
LESTER PART NUMBER				
7756-3	10459553	12	IR	130
WILSON PART NUMBER				
90-02-5064	10459553	12	IR	130

Ford 3G 19020565



Part Number	Reman Number	Volts	Reg	Amps
DELCO REMY REMANUFACTURED PART NUMBER				
19020565	19020565	12	ER	65
FORD O.E. NUMBER				
E7SF10300FA	19020565	12	ER	65

Part Number	Reman Number	Volts	Reg	Amps
LESTER PART NUMBER				
7072-9	19020565	12	ER	65
WILSON PART NUMBER				
90-02-5040	19020565	12	ER	65

Ford 6G 10459585



Part Number	Reman Number	Volts	Reg	Amps
DELCO Remy REMANUFACTURED PART NUMBER				
10459585	10459585	12	IR	105

FORD O.E. NUMBERS				
F81U10300CC	10459585	12	IR	105
F81Z10346CA	10459585	12	IR	105

Part Number	Reman Number	Volts	Reg	Amps
DIXIE PART NUMBER				
A-276	10459585	12	IR	105

LESTER PART NUMBER				
7798	10459585	12	IR	105

Ford 6G 10459502



Part Number	Reman Number	Volts	Reg	Amps
DELCO Remy REMANUFACTURED PART NUMBER				
10459502	10459502	12	IR	105

FORD O.E. NUMBERS				
F81U10300EB	10459502	12	IR	105
F81Z10346EA	10459502	12	IR	105

Part Number	Reman Number	Volts	Reg	Amps
LESTER PART NUMBER				
7796	10459502	12	IR	105

WILSON PART NUMBER				
90-02-5092	10459502	12	IR	105

Ford 6G 10459586



Part Number	Reman Number	Volts	Reg	Amps
DELCO Remy REMANUFACTURED PART NUMBER				
10459586	10459586	12	IR	105

FORD O.E. NUMBERS				
F81U10300DB	10459586	12	IR	105
F81U10300DC	10459586	12	IR	105
F81Z10346DA	10459586	12	IR	105

Part Number	Reman Number	Volts	Reg	Amps
DIXIE PART NUMBER				
A-277	10459586	12	IR	105

LESTER PART NUMBER				
7797	10459586	12	IR	105

REMANUFACTURED ALTERNATORS



Ford 6G 10459587



Part Number	Reman Number	Volts	Reg	Amps
DELCO REMY REMANUFACTURED PART NUMBER				
10459587	10459587	12	IR	105
FORD O.E. NUMBERS				
F81U10300GA	10459587	12	IR	105
F81Z10346GA	10459587	12	IR	105

Part Number	Reman Number	Volts	Reg	Amps
DIXIE PART NUMBER				
A-2025	10459587	12	IR	105
LESTER PART NUMBER				
7799	10459587	12	IR	105

Ford 10459363



Part Number	Reman Number	Volts	Reg	Amps
DELCO REMY REMANUFACTURED PART NUMBER				
10459363	10459363	12	ER	90
FORD O.E. NUMBERS				
D3HF10300AA	10459363	12	ER	90
D4HF10300BA	10459363	12	ER	90
D4HF10346BA	10459363	12	ER	90
D4HZ10346B	10459363	12	ER	90
CUMMINS RECON PART NUMBER				
3604674RX	10459363	12	ER	90

Part Number	Reman Number	Volts	Reg	Amps
DIXIE PART NUMBER				
A-214	10459363	12	ER	90
LESTER PART NUMBER				
7069	10459363	12	ER	90
MIDLAND PART NUMBER				
RA501000X	10459363	12	ER	90
WILSON PART NUMBER				
90-02-5016	10459363	12	ER	90

Ford "Blue Back" 10459364



Part Number	Reman Number	Volts	Reg	Amps
DELCO REMY REMANUFACTURED PART NUMBER				
10459364	10459364	12	ER	90
FORD O.E. NUMBERS				
87HU10300AA	10459364	12	ER	90
E2HF10346BA	10459364	12	ER	90
E2HT10300EB	10459364	12	ER	90
E2HT10300GA	10459364	12	ER	90
E2HT10300AA	10459364	12	ER	90
EZHT10346CA	10459364	12	ER	90
F0HU10346CA	10459364	12	ER	90
F0HU10346FA	10459364	12	ER	90

Part Number	Reman Number	Volts	Reg	Amps
CUMMINS RECON PART NUMBER				
3604675RX	10459364	12	ER	90
DIXIE PART NUMBER				
A-219	10459364	12	ER	90
MIDLAND PART NUMBER				
RA501005X	10459364	12	ER	90
WILSON PART NUMBER				
90-02-5032	10459364	12	ER	90

Ford 10459524



Part Number	Reman Number	Volts	Reg	Amps
DELCO REMY REMANUFACTURED PART NUMBER				
10459524	10459524	6	ER	35
FORD O.E. NUMBER				
FAC10002A	10459524	6	ER	35

Part Number	Reman Number	Volts	Reg	Amps
LESTER PART NUMBER				
5799	10459524	6	ER	35
WILSON PART NUMBER				
92-02-5012	10459524	6	ER	35

Ford 10459525



Part Number	Reman Number	Volts	Reg	Amps
DELCO REMY REMANUFACTURED PART NUMBER				
10459525	10459525	12	ER	60
FORD O.E. NUMBER				
D9HT10300EA	10459525	12	ER	60
DIXIE PART NUMBER				
A-215	10459525	12	ER	60

Part Number	Reman Number	Volts	Reg	Amps
LESTER PART NUMBER				
7078	10459525	12	ER	60
WILSON PART NUMBER				
90-02-5029	10459525	12	ER	60

REMANUFACTURED ALTERNATORS



Ford 10459546



Part Number	Reman Number	Volts	Reg	Amps
-------------	--------------	-------	-----	------

DELCO REMY REMANUFACTURED PART NUMBER

10459546	10459546	12	ER	100
----------	-----------------	----	----	-----

FORD O.E. NUMBERS

D3VY10346A	10459546	12	ER	100
D7VZ10346A	10459546	12	ER	100
E7DF10300EB	10459546	12	ER	100

Part Number	Reman Number	Volts	Reg	Amps
-------------	--------------	-------	-----	------

FORD O.E. NUMBERS (CONT.)

E7VF10300AA	10459546	12	ER	100
E7VF10300BA	10459546	12	ER	100

DIXIE PART NUMBER

A-221	10459546	12	ER	100
-------	-----------------	----	----	-----

LESTER PART NUMBER

7705-12	10459546	12	ER	100
---------	-----------------	----	----	-----

Ford 10459550



Part Number	Reman Number	Volts	Reg	Amps
-------------	--------------	-------	-----	------

DELCO REMY REMANUFACTURED PART NUMBER

10459550	10459550	12	ER	100
----------	-----------------	----	----	-----

FORD O.E. NUMBERS

FOUU10300AA	10459550	12	ER	100
FOUU10300BA	10459550	12	ER	100

Part Number	Reman Number	Volts	Reg	Amps
-------------	--------------	-------	-----	------

DIXIE PART NUMBER

A-221	10459550	12	ER	100
-------	-----------------	----	----	-----

LESTER PART NUMBER

7705-3	10459550	12	ER	100
--------	-----------------	----	----	-----

Ford 10459573



Part Number	Reman Number	Volts	Reg	Amps
-------------	--------------	-------	-----	------

DELCO REMY REMANUFACTURED PART NUMBER

10459573	10459573	12	ER	30
----------	-----------------	----	----	----

FORD O.E. NUMBER

C4TZ1002A	10459573	12	ER	30
-----------	-----------------	----	----	----

DIXIE PART NUMBER

G-203	10459573	12	ER	30
-------	-----------------	----	----	----

Part Number	Reman Number	Volts	Reg	Amps
-------------	--------------	-------	-----	------

LESTER PART NUMBER

5838	10459573	12	ER	30
------	-----------------	----	----	----

WILSON PART NUMBER

90-02-5005	10459573	12	ER	30
------------	-----------------	----	----	----

Ford 10459584



Part Number	Reman Number	Volts	Reg	Amps
DELCO REMY REMANUFACTURED PART NUMBER				
10459584	10459584	12	IR	75

FORD O.E. NUMBERS

E99F10300BA	10459584	12	IR	75
E79F10300BA	10459584	12	IR	75

Part Number	Reman Number	Volts	Reg	Amps
LESTER PART NUMBER				
7735-10	10459584	12	IR	75

WILSON PART NUMBER

90-02-4051	10459584	12	IR	75
------------	----------	----	----	----

Ford 10459588



Part Number	Reman Number	Volts	Reg	Amps
DELCO REMY REMANUFACTURED PART NUMBER				
10459588	10459588	12	ER	90

FORD O.E. NUMBERS

D5ZF10300BA	10459588	12	ER	90
D7OF10300BA	10459588	12	ER	90
D7UF10300CA	10459588	12	ER	90
EZHT10346EB	10459588	12	ER	90

Part Number	Reman Number	Volts	Reg	Amps
LESTER PART NUMBER				
7074-9	10459588	12	ER	90

WILSON PART NUMBER

90-02-5020	10459588	12	ER	90
------------	----------	----	----	----

Ford 10459589



Part Number	Reman Number	Volts	Reg	Amps
DELCO REMY REMANUFACTURED PART NUMBER				
10459589	10459589	12	ER	70

FORD O.E. NUMBERS

D9AF10300CA	10459589	12	ER	70
E1AF10300DA	10459589	12	ER	70
E7UF10300AA	10459589	12	ER	70

Part Number	Reman Number	Volts	Reg	Amps
DIXIE PART NUMBER				
A-217	10459589	12	ER	70

LESTER PART NUMBER

7072-3	10459589	12	ER	70
--------	----------	----	----	----

REMANUFACTURED ALTERNATORS



Ford 10463449



Part Number	Reman Number	Volts	Reg	Amps
DELCO REMY REMANUFACTURED PART NUMBER				
10463449	10463449	12	ER	70
FORD O.E. NUMBERS				
D2FZ10346B	10463449	12	ER	70
D2OZ10346B	10463449	12	ER	70
D4OZ10346D	10463449	12	ER	70
D5OF10300CA	10463449	12	ER	70
D7UF10300AA	10463449	12	ER	70

Part Number	Reman Number	Volts	Reg	Amps
DIXIE PART NUMBER				
A-217	10463449	12	ER	70
LESTER PART NUMBER				
7072-9	10463449	12	ER	70

Hitachi 10459435



Note: Does not include pulley

Part Number	Reman Number	Volts	Reg	Amps
DELCO REMY REMANUFACTURED PART NUMBER				
10459435	10459435	12	IR	74
HITACHI O.E. NUMBER				
LR180-510	10459435	12	IR	74

Part Number	Reman Number	Volts	Reg	Amps
CHEV/GMC PART NUMBER				
97189649	10459435	12	IR	74
ISUZU PART NUMBER				
2-90276-800-0	10459435	12	IR	74

Hitachi 10459437



Note: Does not include pulley

Part Number	Reman Number	Volts	Reg	Amps
DELCO REMY REMANUFACTURED PART NUMBER				
10459437	10459437	12	IR	67
HITACHI O.E. NUMBER				
LR180-410H	10459437	12	IR	67

Part Number	Reman Number	Volts	Reg	Amps
CHEV/GMC PART NUMBER				
94052403	10459437	12	IR	67
ISUZU PART NUMBER				
2-91276-024-0	10459437	12	IR	67

Hitachi 10459447



Note: Does not include pulley

Part Number	Reman Number	Volts	Reg	Amps
DELCO REMY REMANUFACTURED PART NUMBER				
10459447	10459447	12	IR	74
HITACHI O.E. NUMBER				
LR180-509R	10459447	12	IR	74

Part Number	Reman Number	Volts	Reg	Amps
CHEV/GMC PART NUMBER				
97189650	10459447	12	IR	74
ISUZU PART NUMBERS				
2-90276-810-0	10459447	12	IR	74
8-97189-650-0	10459447	12	IR	74

Hitachi 10459448

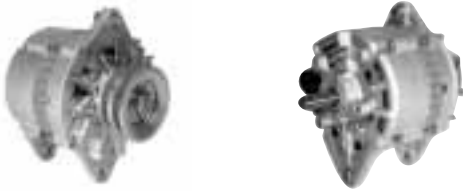

Note: Does not include pulley

Part Number	Reman Number	Volts	Reg	Amps
DELCO REMY REMANUFACTURED PART NUMBER				
10459448	10459448	12	IR	67
HITACHI O.E. NUMBERS				
LR170-418	10459448	12	IR	67
LR170-418B	10459448	12	IR	67
CHEV/GMC PART NUMBER				
97189650	10459448	12	IR	67

Part Number	Reman Number	Volts	Reg	Amps
DIXIE PART NUMBER				
A-8531	10459448	12	IR	67
LESTER PART NUMBER				
12097	10459448	12	IR	67
WILSON PART NUMBER				
90-25-1089	10459448	12	IR	67

Hitachi 10459466



Note: Does not include pulley

Part Number	Reman Number	Volts	Reg	Amps
DELCO REMY REMANUFACTURED PART NUMBER				
10459466	10459466	12	IR	80
HITACHI O.E. NUMBER				
LR180-503C	10459466	12	IR	80

Part Number	Reman Number	Volts	Reg	Amps
CHEV/GMC PART NUMBER				
94052185	10459466	12	IR	80
ISUZU PART NUMBER				
2-91276-300-0	10459466	12	IR	80

REMANUFACTURED ALTERNATORS



Hitachi 10459467



Note: Does not include pulley

Part Number	Reman Number	Volts	Reg	Amps
DELCO REMY REMANUFACTURED PART NUMBER				
10459467	10459467	12	IR	80
HITACHI O.E. NUMBER				
LR180-509C	10459467	12	IR	80

Part Number	Reman Number	Volts	Reg	Amps
CHEV/GMC PART NUMBER				
97116697	10459467	12	IR	80
ISUZU PART NUMBER				
8-97116-697-3	10459467	12	IR	80

Hitachi 10459496



Note: Does not include pulley

Part Number	Reman Number	Volts	Reg	Amps
DELCO REMY REMANUFACTURED PART NUMBER				
10459496	10459496	12	IR	40
HITACHI O.E. NUMBER				
LR140-714B	10459496	12	IR	40

Part Number	Reman Number	Volts	Reg	Amps
LESTER PART NUMBER				
12112	10459496	12	IR	40
WILSON PART NUMBER				
90-25-1095	10459496	12	IR	40

Hitachi 10459497



Part Number	Reman Number	Volts	Reg	Amps
DELCO REMY REMANUFACTURED PART NUMBER				
10459497	10459497	12	ER	20
HITACHI O.E. NUMBER				
LT120-07	10459497	12	ER	20
DIXIE PART NUMBER				
A-8157	10459497	12	ER	20

Part Number	Reman Number	Volts	Reg	Amps
LESTER PART NUMBER				
12128	10459497	12	ER	20
WILSON PART NUMBER				
90-25-1016	10459497	12	ER	20

Leece Neville JB Series



Part Number	Reman Number	Volts	Battery Term	R Term	I Term	Amps
-------------	--------------	-------	--------------	--------	--------	------

DELCO REMY REMANUFACTURED PART NUMBERS

10459021	10459021	12	5/16	PIN	-	90
10459022	10459022	12	5/16	PIN	-	105
10459080	10459080	12	5/16	PIN	-	65
10459081	10459081	12	5/16	PIN	-	145
10459458	10459458	12	-	-	-	130
10459459	10459459	12	-	-	-	160

LEECE NEVILLE O.E. NUMBERS

2300JB	10459080	12	5/16	PIN	-	65
2500JB	10459021	12	5/16	PIN	-	90
2600JB	10459022	12	5/16	PIN	-	105
2670LC	10459458	12	-	-	-	130
2700JB	10459458	12	-	-	-	130
2800JB	10459459	12	-	-	-	160
2805JB	10459081	12	5/16	PIN	-	145
RJ2500	10459022	12	5/16	PIN	-	105
RJ2526	10459022	12	5/16	PIN	-	105
RJ2600	10459022	12	5/16	PIN	-	105
RJ2670	10459458	12	-	-	-	130
RJ2700	10459458	12	-	-	-	130
RJ2800	10459459	12	-	-	-	160
RJ2805	10459081	12	5/16	PIN	-	145

DELCO REMY O.E. PART NUMBERS

10459021	10459021	12	5/16	PIN	-	90
10459022	10459022	12	5/16	PIN	-	105
10459080	10459080	12	5/16	PIN	-	65
10459081	10459081	12	5/16	PIN	-	145
10459139	10459021	12	5/16	PIN	-	90
10459140	10459022	12	5/16	PIN	-	105
10459208	10459081	12	5/16	PIN	-	145
10459458	10459458	12	-	-	-	130
10459459	10459459	12	-	-	-	160

AC DELCO CATALOG NUMBERS

321-703	10459021	12	5/16	PIN	-	90
321-704	10459022	12	5/16	PIN	-	105
321-705	10459080	12	5/16	PIN	-	65
321-706	10459081	12	5/16	PIN	-	145

Part Number	Reman Number	Volts	Battery Term	R Term	I Term	Amps
-------------	--------------	-------	--------------	--------	--------	------

CHAMPION PART NUMBERS

6060	10459080	12	5/16	PIN	-	65
6061	10459021	12	5/16	PIN	-	90
6062	10459022	12	5/16	PIN	-	105
6063	10459081	12	5/16	PIN	-	145

CUMMINS RECON PART NUMBERS

3603857RX	10459080	12	5/16	PIN	-	65
3603858RX	10459021	12	5/16	PIN	-	90
3603859RX	10459022	12	5/16	PIN	-	105
3604234RX	10459458	12	-	-	-	130
3675161RX	10459459	12	-	-	-	160

DDC CATALOG NUMBERS

R0459139	10459021	12	5/16	PIN	-	90
R0459140	10459022	12	5/16	PIN	-	105
R0459208	10459081	12	5/16	PIN	-	145

DDC PART NUMBERS

10459139	10459021	12	5/16	PIN	-	90
10459140	10459022	12	5/16	PIN	-	105
10459208	10459081	12	5/16	PIN	-	145

DIXIE PART NUMBERS

A-720	10459021	12	5/16	PIN	-	90
A-720	10459022	12	5/16	PIN	-	105
A-720	10459080	12	5/16	PIN	-	65
A-721	10459458	12	-	-	-	130
A-754	10459081	12	5/16	PIN	-	145

MIDLAND PART NUMBERS

RA225000X	10459021	12	5/16	PIN	-	90
RA226000X	10459022	12	5/16	PIN	-	105
RA227000X	10459458	12	-	-	-	130
RA228000X	10459459	12	-	-	-	160

WILSON PART NUMBERS

90-04-7020	10459021	12	5/16	PIN	-	90
90-04-7020	10459022	12	5/16	PIN	-	105
90-04-7021	10459458	12	-	-	-	130
90-04-7039	10459081	12	5/16	PIN	-	145

REMANUFACTURED ALTERNATORS



Leece Neville 10459545



Part Number	Reman Number	Volts	Reg	Amps
DELCO REMY REMANUFACTURED PART NUMBER				
10459545	10459545	12	IR	165
LEECE NEVILLE O.E. NUMBERS				
7711J	10459545	12	IR	165
7711JA	10459545	12	IR	165
90762	10459545	12	IR	165
A001090762	10459545	12	IR	165
DELCO REMY O.E. PART NUMBER				
10459545	10459545	12	IR	165

Part Number	Reman Number	Volts	Reg	Amps
DIXIE PART NUMBER				
A-761	10459545	12	IR	165
LESTER PART NUMBER				
7772	10459545	12	IR	165
WILSON PART NUMBER				
90-04-7053	10459545	12	IR	165

Leece Neville 10459567



Part Number	Reman Number	Volts	Reg	Amps
DELCO REMY REMANUFACTURED PART NUMBER				
10459567	10459567	12	ER	90
LEECE NEVILLE O.E. NUMBERS				
7501A	10459567	12	ER	90
7501AA	10459567	12	ER	90
DELCO REMY O.E. PART NUMBER				
10459567	10459567	12	ER	90

Part Number	Reman Number	Volts	Reg	Amps
DIXIE PART NUMBER				
A-732	10459567	12	ER	90
LESTER PART NUMBER				
7638	10459567	12	ER	90
WILSON PART NUMBER				
90-04-7023	10459567	12	ER	90

Leece Neville 10459568



Part Number	Reman Number	Volts	Reg	Amps
DELCO REMY REMANUFACTURED PART NUMBER				
10459568	10459568	12	ER	105
LEECE NEVILLE O.E. NUMBERS				
7601A	10459568	12	ER	105
7601AA	10459568	12	ER	105
7603A	10459568	12	ER	105
7603AA	10459568	12	ER	105
7604A	10459568	12	ER	105
7604AA	10459568	12	ER	105

Part Number	Reman Number	Volts	Reg	Amps
DELCO REMY O.E. PART NUMBER				
10459568	10459568	12	ER	105
DIXIE PART NUMBER				
A-732	10459568	12	ER	105
LESTER PART NUMBER				
7637	10459568	12	ER	105
WILSON PART NUMBER				
90-04-7023	10459568	12	ER	105

Leece Neville 10459569



Part Number	Reman Number	Volts	Reg	Amps
DELCO REMY REMANUFACTURED PART NUMBER				
10459569	10459569	12	IR	65
LEECE NEVILLE O.E. NUMBERS				
7014AA	10459569	12	IR	65
7024AA	10459569	12	IR	65
A001090600	10459569	12	IR	65
A200099129	10459569	12	IR	65
DELCO REMY O.E. PART NUMBER				
10459569	10459569	12	IR	65

Part Number	Reman Number	Volts	Reg	Amps
DIXIE PART NUMBER				
A-717	10459569	12	IR	65
LESTER PART NUMBER				
7625	10459569	12	IR	65
WILSON PART NUMBER				
90-04-7017	10459569	12	IR	65

REMANUFACTURED ALTERNATORS



Mando 10459512



Part Number	Reman Number	Volts	Reg	Amps
DELCO REMY REMANUFACTURED PART NUMBER				
10459512	10459512	12	IR	55
MANDO O.E. NUMBER				
AR150AA	10459512	12	IR	55
DIXIE PART NUMBER				
A-8311	10459512	12	IR	55

Part Number	Reman Number	Volts	Reg	Amps
LESTER PART NUMBER				
12174	10459512	12	IR	55
WILSON PART NUMBER				
90-31-7001	10459512	12	IR	55

Mando 10459513

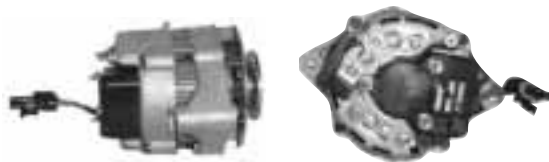

Part Number	Reman Number	Volts	Reg	Amps
DELCO REMY REMANUFACTURED PART NUMBER				
10459513	10459513	12	IR	55
MANDO O.E. NUMBERS				
AC155513	10459513	12	IR	55
AR150CA	10459513	12	IR	55
AR150DA	10459513	12	IR	55

Part Number	Reman Number	Volts	Reg	Amps
DIXIE PART NUMBER				
A-8396	10459513	12	IR	55
LESTER PART NUMBER				
12175	10459513	12	IR	55
WILSON PART NUMBER				
90-31-7000	10459513	12	IR	55

Mitsubishi 10459504

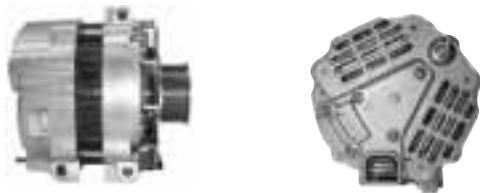

Part Number	Reman Number	Volts	Reg	Amps
DELCO REMY REMANUFACTURED PART NUMBER				
10459504	10459504	12	IR	215
MITSUBISHI O.E. NUMBERS				
A8TU0091	10459504	12	IR	215
A008TU0091	10459504	12	IR	215

Part Number	Reman Number	Volts	Reg	Amps
DIXIE PART NUMBER				
A-8490	10459504	12	IR	215
LESTER PART NUMBER				
12075	10459504	12	IR	215
WILSON PART NUMBER				
90-27-3135	10459504	12	IR	215

Motorola 10459454



Part Number	Reman Number	Volts	Reg	Amps
DELCO REMY REMANUFACTURED PART NUMBER				
10459454	10459454	12	IR	130
MOTOROLA O.E. NUMBERS				
8LHA205OVA	10459454	12	IR	130
8LHA205OVAS	10459454	12	IR	130
CUMMINS RECON PART NUMBER				
3604683RX	10459454	12	IR	130
DIXIE PART NUMBER				
A-9233	10459454	12	IR	130

Part Number	Reman Number	Volts	Reg	Amps
LESTER PART NUMBER				
8059	10459454	12	IR	130
PRESTOLITE PART NUMBER				
110-454	10459454	12	IR	130
WILSON PART NUMBER				
90-05-9176	10459454	12	IR	130

Motorola 10459528



Part Number	Reman Number	Volts	Reg	Amps
DELCO REMY REMANUFACTURED PART NUMBER				
10459528	10459528	12	IR	37
MOTOROLA O.E. NUMBER				
RA12NJD453	10459528	12	IR	37
DIXIE PART NUMBER				
A-921	10459528	12	IR	37

Part Number	Reman Number	Volts	Reg	Amps
LESTER PART NUMBER				
7356	10459528	12	IR	37
WILSON PART NUMBER				
90-05-9021	10459528	12	IR	37

Motorola 10459529



Part Number	Reman Number	Volts	Reg	Amps
DELCO REMY REMANUFACTURED PART NUMBER				
10459529	10459529	12	IR	55
MOTOROLA O.E. NUMBER				
RA12NJD604	10459529	12	IR	55

Part Number	Reman Number	Volts	Reg	Amps
LESTER PART NUMBER				
7357	10459529	12	IR	55
WILSON PART NUMBER				
90-05-9024	10459529	12	IR	55

REMANUFACTURED ALTERNATORS



Motorola 10459530



Part Number	Reman Number	Volts	Reg	Amps
DELCO REMY REMANUFACTURED PART NUMBER				
10459530	10459530	12	ER	51
MOTOROLA O.E. NUMBER				
A12N600	10459530	12	ER	51
DIXIE PART NUMBER				
A-927	10459530	12	ER	51

Part Number	Reman Number	Volts	Reg	Amps
LESTER PART NUMBER				
7361	10459530	12	ER	51
PRESTOLITE O.E. NUMBER				
110-3	10459530	12	ER	51
WILSON PART NUMBER				
90-05-9027	10459530	12	ER	51

Motorola 10459531



Part Number	Reman Number	Volts	Reg	Amps
DELCO REMY REMANUFACTURED PART NUMBER				
10459531	10459531	12	IR	51
MOTOROLA O.E. NUMBER				
RA12N600D	10459531	12	IR	51
DIXIE PART NUMBER				
A-924	10459531	12	IR	51

Part Number	Reman Number	Volts	Reg	Amps
LESTER PART NUMBER				
7365	10459531	12	IR	51
PRESTOLITE O.E. NUMBER				
110-157	10459531	12	IR	51
WILSON PART NUMBER				
90-05-9077	10459531	12	IR	51

Motorola 10459533



Part Number	Reman Number	Volts	Reg	Amps
DELCO REMY REMANUFACTURED PART NUMBER				
10459533	10459533	12	ER	72
MOTOROLA O.E. NUMBER				
8MA2014P	10459533	12	ER	72
DIXIE PART NUMBER				
A-9179	10459533	12	ER	72

Part Number	Reman Number	Volts	Reg	Amps
LESTER PART NUMBER				
7374	10459533	12	ER	72
WILSON PART NUMBER				
90-05-9113	10459533	12	ER	72

Motorola 10459534

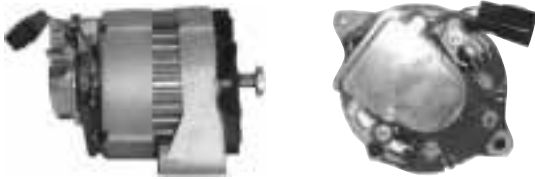

Part Number	Reman Number	Volts	Reg	Amps
DELCO REMY REMANUFACTURED PART NUMBER				
10459534	10459534	12	IR	72
MOTOROLA O.E. NUMBERS				
8MR2012P	10459534	12	IR	72
8MR2008P	10459534	12	IR	72
8MR2009P	10459534	12	IR	72
8MR2010P	10459534	12	IR	72
DIXIE PART NUMBER				
A-9174	10459534	12	IR	72

Part Number	Reman Number	Volts	Reg	Amps
LESTER PART NUMBER				
7376	10459534	12	IR	72
PRESTOLITE PART NUMBERS				
110-266	10459534	12	IR	72
110-115	10459534	12	IR	72
WILSON PART NUMBER				
90-05-9063	10459534	12	IR	72

Motorola 10459535



Part Number	Reman Number	Volts	Reg	Amps
DELCO REMY REMANUFACTURED PART NUMBER				
10459535	10459535	12	ER	55
MOTOROLA O.E. NUMBER				
8AL2056K	10459535	12	ER	55
DIXIE PART NUMBER				
A-9105	10459535	12	ER	55

Part Number	Reman Number	Volts	Reg	Amps
LESTER PART NUMBER				
7377	10459535	12	ER	55
WILSON PART NUMBER				
90-05-9076	10459535	12	ER	55

Motorola 10459536



Part Number	Reman Number	Volts	Reg	Amps
DELCO REMY REMANUFACTURED PART NUMBER				
10459536	10459536	12	IR	37
MOTOROLA O.E. NUMBER				
RA12N451	10459536	12	IR	37
DIXIE PART NUMBER				
A-953	10459536	12	IR	37

Part Number	Reman Number	Volts	Reg	Amps
LESTER PART NUMBER				
7380	10459536	12	IR	37
PRESTOLITE PART NUMBER				
110-54	10459536	12	IR	37
WILSON PART NUMBER				
90-05-9055	10459536	12	IR	37

REMANUFACTURED ALTERNATORS



Motorola 10459539



Part Number	Reman Number	Volts	Reg	Amps
DELCO REMY REMANUFACTURED PART NUMBER				
10459539	10459539	12	IR	62
MOTOROLA O.E. NUMBER				
9DB2LG2B58	10459539	12	IR	62
DIXIE PART NUMBER				
A-9251	10459539	12	IR	62
LESTER PART NUMBER				
7454	10459539	12	IR	62

Part Number	Reman Number	Volts	Reg	Amps
PRESTOLITE O.E. NUMBERS				
110-460	10459539	12	IR	62
110-742	10459539	12	IR	62
110-747	10459539	12	IR	62
110-747A	10459539	12	IR	62
WILSON PART NUMBER				
90-05-9157	10459539	12	IR	62

Motorola 10459540



Part Number	Reman Number	Volts	Reg	Amps
DELCO REMY REMANUFACTURED PART NUMBER				
10459540	10459540	12	IR	42
MOTOROLA O.E. NUMBER				
8HC3010G	10459540	12	IR	42
DIXIE PART NUMBER				
A-9118	10459540	12	IR	42

Part Number	Reman Number	Volts	Reg	Amps
LESTER PART NUMBER				
7458	10459540	12	IR	42
WILSON PART NUMBER				
90-05-9107	10459540	12	IR	42

Motorola 10459541



Part Number	Reman Number	Volts	Reg	Amps
DELCO REMY REMANUFACTURED PART NUMBER				
10459541	10459541	12	IR	90
MOTOROLA O.E. NUMBER				
8MR2033T	10459541	12	IR	90
DIXIE PART NUMBER				
A-9160	10459541	12	IR	90

Part Number	Reman Number	Volts	Reg	Amps
LESTER PART NUMBER				
7471	10459541	12	IR	90
PRESTOLITE O.E. NUMBER				
110-252	10459541	12	IR	90
WILSON PART NUMBER				
90-05-9104	10459541	12	IR	90

Motorola 10459542



Part Number	Reman Number	Volts	Reg	Amps
DELCO Remy REMANUFACTURED PART NUMBER				
10459542	10459542	12	ER	72
MOTOROLA O.E. NUMBER				
8MA2003P	10459542	12	ER	72
DIXIE PART NUMBER				
A-976	10459542	12	ER	72

Part Number	Reman Number	Volts	Reg	Amps
LESTER PART NUMBER				
7473	10459542	12	ER	72
PRESTOLITE PART NUMBER				
110-141	10459542	12	ER	72
WILSON PART NUMBER				
90-05-9079	10459542	12	ER	72

Motorola 10459543



Part Number	Reman Number	Volts	Reg	Amps
DELCO Remy REMANUFACTURED PART NUMBER				
10459543	10459543	24	IR	42
MOTOROLA O.E. NUMBERS				
8EM3002GA	10459543	24	IR	42
8EM3002GB	10459543	24	IR	42
8EM3002GC	10459543	24	IR	42

Part Number	Reman Number	Volts	Reg	Amps
LESTER PART NUMBER				
7483	10459543	24	IR	42
PRESTOLITE PART NUMBERS				
110-376	10459543	24	IR	42
110-486	10459543	24	IR	42
WILSON PART NUMBER				
90-05-9154	10459543	24	IR	42

Motorola 10459548

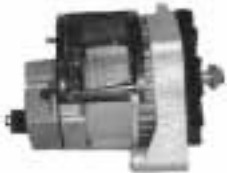

Part Number	Reman Number	Volts	Reg	Amps
DELCO Remy REMANUFACTURED PART NUMBER				
10459548	10459548	12	IR	90
MOTOROLA O.E. NUMBERS				
8MR2030TS	10459548	12	IR	90
8MR2030T	10459548	12	IR	90
DIXIE PART NUMBER				
A-9232	10459548	12	IR	90

Part Number	Reman Number	Volts	Reg	Amps
LESTER PART NUMBER				
8045	10459548	12	IR	90
PRESTOLITE PART NUMBER				
110-242	10459548	12	IR	90
WILSON PART NUMBER				
90-05-9158	10459548	12	IR	90

REMANUFACTURED ALTERNATORS



Motorola 10459549



Part Number	Reman Number	Volts	Reg	Amps
DELCO Remy REMANUFACTURED PART NUMBER				
10459549	10459549	12	IR	65
MOTOROLA O.E. NUMBERS				
8EM2009	10459549	12	IR	65
8EM2009N	10459549	12	IR	65
8EM2009NA	10459549	12	IR	65
8EM2009NB	10459549	12	IR	65
8EM2009ND	10459549	12	IR	65

Part Number	Reman Number	Volts	Reg	Amps
DIXIE PART NUMBER				
A-9222	10459549	12	IR	65
LESTER PART NUMBER				
8047	10459549	12	IR	65
WILSON PART NUMBER				
90-05-9159	10459549	12	IR	65

Motorola 10459555



Part Number	Reman Number	Volts	Reg	Amps
DELCO Remy REMANUFACTURED PART NUMBER				
10459555	10459555	12	IR	130
MOTOROLA O.E. NUMBERS				
8LHA2023V	10459555	12	IR	130
8LHA2023VA	10459555	12	IR	130
8LHA2070V	10459555	12	IR	130
8LHA2070VA	10459555	12	IR	130
8LHA2070VB	10459555	12	IR	130
CUMMINS RECON CATALOG NUMBER				
3675200RX	10459555	12	IR	130
DIXIE PART NUMBER				
A-9204	10459555	12	IR	130

Part Number	Reman Number	Volts	Reg	Amps
MIDLAND PART NUMBER				
RA403000X	10459555	12	IR	130
PRESTOLITE PART NUMBERS				
110-255	10459555	12	IR	130
110-555	10459555	12	IR	130
110-565	10459555	12	IR	130
WILSON CATALOG NUMBERS				
90-05-9124	10459555	12	IR	130
90-31-7001	10459555	12	IR	130

Motorola 10459570



Part Number	Reman Number	Volts	Reg	Amps
DELCO REMY REMANUFACTURED PART NUMBER				
10459570	10459570	12	ER	37
MOTOROLA O.E. NUMBERS				
812NJD453	10459570	12	ER	37
812NJD454	10459570	12	ER	37
DIXIE PART NUMBER				
A-919	10459570	12	ER	37

Part Number	Reman Number	Volts	Reg	Amps
LESTER PART NUMBER				
7353	10459570	12	ER	37
WILSON PART NUMBER				
90-05-9019	10459570	12	ER	37

Motorola 10459571



Part Number	Reman Number	Volts	Reg	Amps
DELCO REMY REMANUFACTURED PART NUMBER				
10459571	10459571	12	ER	37
MOTOROLA O.E. NUMBER				
8LF2055F	10459571	12	ER	37
DIXIE PART NUMBER				
A-9130	10459571	12	ER	37

Part Number	Reman Number	Volts	Reg	Amps
LESTER PART NUMBER				
7378	10459571	12	ER	37
WILSON PART NUMBER				
90-05-9114	10459571	12	ER	37

REMANUFACTURED ALTERNATORS



Motorola 19020509



Part Number	Reman Number	Volts	Battery Term	R Term	I Term	Amps
DELCO REMY REMANUFACTURED PART NUMBER						
19020509	19020509	12	1/4	#10	#10	37
MOTOROLA O.E. NUMBER						
8HA2003F	19020509	12	1/4	#10	#10	37
8HA2003FS	19020509	12	1/4	#10	#10	37
8HA2006F	19020509	12	1/4	#10	#10	37
AC DELCO CATALOG NUMBER						
321-770	19020509	12	1/4	#10	#10	37
CARRIER PART NUMBER						
20-44-3325	19020509	12	1/4	#10	#10	37
30-00251-11	19020509	12	1/4	#10	#10	37
30-00331-00	19020509	12	1/4	#10	#10	37
CUMMINS RECON PART NUMBER						
3675142RX	19020509	12	1/4	#10	#10	37

Part Number	Reman Number	Volts	Battery Term	R Term	I Term	Amps
DIXIE PART NUMBER						
A-988	19020509	12	1/4	#10	#10	37
LESTER PART NUMBER						
7444	19020509	12	1/4	#10	#10	37
MIDLAND PART NUMBER						
RA402002X	19020509	12	1/4	#10	#10	37
PRESTOLITE O.E. NUMBER						
110-159	19020509	12	1/4	#10	#10	37
THERMO KING PART NUMBERS						
44-5004	19020509	12	1/4	#10	#10	37
44-3325	19020509	12	1/4	#10	#10	37
WILSON PART NUMBER						
90-05-9082	19020509	12	1/4	#10	#10	37

Motorola 19020510

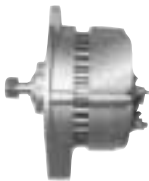

Part Number	Reman Number	Volts	Battery Term	R Term	I Term	Amps
DELCO REMY REMANUFACTURED PART NUMBER						
19020510	19020510	12	1/4	#10	#10	51
MOTOROLA O.E. NUMBER						
8HA2009K	19020510	12	1/4	#10	#10	51
AC DELCO CATALOG NUMBER						
321-771	19020510	12	1/4	#10	#10	51
CARRIER PART NUMBER						
20-44-6257	19020510	12	1/4	#10	#10	51
CUMMINS RECON PART NUMBERS						
3675144RX	19020510	12	1/4	#10	#10	51
3675145RX	19020510	12	1/4	#10	#10	51
DIXIE PART NUMBER						
A-9209	19020510	12	1/4	#10	#10	51

Part Number	Reman Number	Volts	Battery Term	R Term	I Term	Amps
LESTER PART NUMBER						
7486	19020510	12	1/4	#10	#10	51
MIDLAND PART NUMBER						
RA403003X	19020510	12	1/4	#10	#10	51
PRESTOLITE O.E. NUMBERS						
110-303	19020510	12	1/4	#10	#10	51
110-304	19020510	12	1/4	#10	#10	51
THERMO KING PART NUMBERS						
44-6257	19020510	12	1/4	#10	#10	51
44-6266	19020510	12	1/4	#10	#10	51
WILSON PART NUMBER						
90-05-9152	19020510	12	1/4	#10	#10	51

Motorola 19020512



Part Number	Reman Number	Volts	Battery Term	R Term	I Term	Amps
DELCO REMY REMANUFACTURED PART NUMBER						
19020512	19020512	12	1/4	#10	#10	65

MOTOROLA O.E. NUMBERS

8EK2005NC	19020512	12	1/4	#10	#10	65
8EK2005ND	19020512	12	1/4	#10	#10	65
8EK2007NA	19020512	12	1/4	#10	#10	65
8EK2010N	19020512	12	1/4	#10	#10	65
8EK2010NA	19020512	12	1/4	#10	#10	65
8EK2010NB	19020512	12	1/4	#10	#10	65
8MR2185L	19020512	12	1/4	#10	#10	65

AC DELCO CATALOG NUMBER

321-773	19020512	12	1/4	#10	#10	65
---------	-----------------	----	-----	-----	-----	----

CUMMINS RECON PART NUMBER

3675146RX	19020512	12	1/4	#10	#10	65
-----------	-----------------	----	-----	-----	-----	----

Part Number	Reman Number	Volts	Battery Term	R Term	I Term	Amps
DIXIE PART NUMBER						
A-9211	19020512	12	1/4	#10	#10	65

MIDLAND PART NUMBER

RA407007X	19020512	12	1/4	#10	#10	65
-----------	-----------------	----	-----	-----	-----	----

PRESTOLITE PART NUMBER

110-600	19020512	12	1/4	#10	#10	65
---------	-----------------	----	-----	-----	-----	----

THERMO KING PART NUMBERS

44-7156	19020512	12	1/4	#10	#10	65
44-7927	19020512	12	1/4	#10	#10	65
44-8904	19020512	12	1/4	#10	#10	65
44-8940	19020512	12	1/4	#10	#10	65
44-9753	19020512	12	1/4	#10	#10	65
44-9755	19020512	12	1/4	#10	#10	65

WILSON PART NUMBER

90-05-9151	19020512	12	1/4	#10	#10	65
------------	-----------------	----	-----	-----	-----	----

Motorola 19020514

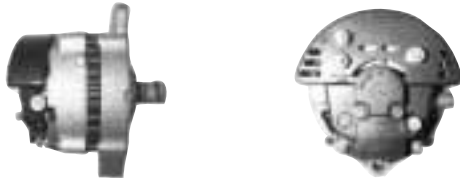

Part Number	Reman Number	Volts	Battery Term	R Term	I Term	Amps
DELCO REMY REMANUFACTURED PART NUMBER						
19020514	19020514	12	1/4	#10	#10	23

MOTOROLA O.E. NUMBER

8EK2004DC	19020514	12	1/4	#10	#10	23
-----------	-----------------	----	-----	-----	-----	----

CARRIER PART NUMBER

30-00409-06	19020514	12	1/4	#10	#10	23
-------------	-----------------	----	-----	-----	-----	----

PRESTOLITE O.E. NUMBER

8MR2127LA	19020514	12	1/4	#10	#10	23
-----------	-----------------	----	-----	-----	-----	----

Part Number	Reman Number	Volts	Battery Term	R Term	I Term	Amps
PRESTOLITE PART NUMBER						
110-399	19020514	12	1/4	#10	#10	23

THERMO KING PART NUMBERS

44-7924	19020514	12	1/4	#10	#10	23
44-9752	19020514	12	1/4	#10	#10	23

WILSON PART NUMBER

90-05-9170	19020514	12	1/4	#10	#10	23
------------	-----------------	----	-----	-----	-----	----

REMANUFACTURED ALTERNATORS



Motorola 19020515



Part Number	Reman Number	Battery Volts	Term	R Term	I Term	Amps
DELCO REMY REMANUFACTURED PART NUMBER						
19020515	19020515	12	1/4	#10	#10	37
MOTOROLA O.E. NUMBER						
8MR2175F	19020515	12	1/4	#10	#10	37
AC DELCO CATALOG NUMBERS						
321-772	19020515	12	1/4	#10	#10	37
321-774	19020515	12	1/4	#10	#10	37
CUMMINS RECON PART NUMBER						
3675146RX	19020515	12	1/4	#10	#10	37
DIXIE PART NUMBERS						
A-9210	19020515	12	1/4	#10	#10	37
A-9247	19020515	12	1/4	#10	#10	37

Part Number	Reman Number	Battery Volts	Term	R Term	I Term	Amps
MIDLAND PART NUMBER						
RA405005X	19020515	12	1/4	#10	#10	37
THERMO KING PART NUMBERS						
44-7155	19020515	12	1/4	#10	#10	37
44-7925	19020515	12	1/4	#10	#10	37
44-9750	19020515	12	1/4	#10	#10	37
44-8091	19020515	12	1/4	#10	#10	37
44-8939	19020515	12	1/4	#10	#10	37

Motorola 19020519



Part Number	Reman Number	Volts	Reg	Amps
DELCO REMY REMANUFACTURED PART NUMBER				
19020519	19020519	12	IR	65
MOTOROLA O.E. NUMBER				
8MR2127LA	19020519	12	IR	65
CARRIER PART NUMBERS				
30-00409-02	19020519	12	IR	65
30-00409-04	19020519	12	IR	65

Part Number	Reman Number	Volts	Reg	Amps
CARRIER PART NUMBERS (CONT.)				
30-00409-06	19020519	12	IR	65
30-00409-07	19020519	12	IR	65
30-00409-10	19020519	12	IR	65
WILSON PART NUMBER				
90-05-9209	19020519	12	IR	65

Motorola 19020520



Part Number	Reman Number	Volts	Battery Term	R Term	I Term	Amps
-------------	--------------	-------	--------------	--------	--------	------

DELCO REMY REMANUFACTURED PART NUMBER

19020520	19020520	12	1/4	#10	#10	37
----------	-----------------	----	-----	-----	-----	----

MOTOROLA O.E. NUMBERS

8A62019F	19020520	12	1/4	#10	#10	37
8AK2069F	19020520	12	1/4	#10	#10	37

AC DELCO CATALOG NUMBER

321-775	19020520	12	1/4	#10	#10	37
---------	-----------------	----	-----	-----	-----	----

CARRIER PART NUMBERS

30-00171-00	19020520	12	1/4	#10	#10	37
30-00171-11	19020520	12	1/4	#10	#10	37
30-00351-00	19020520	12	1/4	#10	#10	37
30-00228-00	19020520	12	1/4	#10	#10	37
30-00351-02	19020520	12	1/4	#10	#10	37
30-00351-04	19020520	12	1/4	#10	#10	37

Part Number	Reman Number	Volts	Battery Term	R Term	I Term	Amps
-------------	--------------	-------	--------------	--------	--------	------

CUMMINS RECON PART NUMBER

3675139RX	19020520	12	1/4	#10	#10	37
-----------	-----------------	----	-----	-----	-----	----

DIXIE PART NUMBER

A-927	19020520	12	1/4	#10	#10	37
-------	-----------------	----	-----	-----	-----	----

PRESTOLITE O.E. NUMBER

110-273	19020520	12	1/4	#10	#10	37
---------	-----------------	----	-----	-----	-----	----

WILSON PART NUMBER

90-05-9028	19020520	12	1/4	#10	#10	37
------------	-----------------	----	-----	-----	-----	----

Motorola 19020543



Part Number	Reman Number	Volts	Reg	Amps
-------------	--------------	-------	-----	------

DELCO REMY REMANUFACTURED PART NUMBER

19020543	19020543	12	ER	37
----------	-----------------	----	----	----

MOTOROLA O.E. NUMBER

8HA2008FA	19020543	12	ER	37
-----------	-----------------	----	----	----

CUMMINS RECON PART NUMBERS

3675144RX	19020543	12	ER	37
3675145RX	19020543	12	ER	37

LESTER PART NUMBER

7486	19020543	12	ER	37
------	-----------------	----	----	----

Part Number	Reman Number	Volts	Reg	Amps
-------------	--------------	-------	-----	------

MIDLAND PART NUMBER

RA401000X	19020543	12	ER	37
-----------	-----------------	----	----	----

PRESTOLITE PART NUMBER

110-303	19020543	12	ER	37
---------	-----------------	----	----	----

THERMO KING PART NUMBERS

44-6257	19020543	12	ER	37
44-6266	19020543	12	ER	37

WILSON PART NUMBER

90-05-9152	19020543	12	ER	37
------------	-----------------	----	----	----

REMANUFACTURED ALTERNATORS



Motorola 19020544



Part Number	Reman Number	Volts	Reg	Amps
DELCO REMY REMANUFACTURED PART NUMBER				
19020544	19020544	12	ER	55
MOTOROLA O.E. NUMBER				
8HA2005K	19020544	12	ER	55
CUMMINS RECON PART NUMBER				
3674143RX	19020544	12	ER	55
LESTER PART NUMBER				
7485	19020544	12	ER	55

Part Number	Reman Number	Volts	Reg	Amps
PRESTOLITE PART NUMBER				
110-253	19020544	12	ER	55
THERMO KING PART NUMBERS				
44-4181	19020544	12	ER	55
44-5004	19020544	12	ER	55
WILSON PART NUMBER				
90-05-9138	19020544	12	ER	55

Motorola 19020545



Part Number	Reman Number	Volts	Reg	Amps
DELCO REMY REMANUFACTURED PART NUMBER				
19020545	19020545	12	IR	37
MOTOROLA O.E. NUMBER				
8EA2001FA	19020545	12	IR	37
CARRIER PART NUMBER				
30-50005	19020545	12	IR	37
30-50009-00	19020545	12	IR	37
CUMMINS RECON PART NUMBER				
3675140RX	19020545	12	IR	37

Part Number	Reman Number	Volts	Reg	Amps
DIXIE PART NUMBER				
A-9212	19020545	12	IR	37
LESTER PART NUMBER				
7566	19020545	12	IR	37
PRESTOLITE PART NUMBER				
110-329	19020545	12	IR	37
WILSON PART NUMBER				
90-05-9136	19020545	12	IR	37

Motorola 19020546



Part Number	Reman Number	Volts	Reg	Amps
DELCO REMY REMANUFACTURED PART NUMBER				
19020546	19020546	12	IR	65
MOTOROLA O.E. NUMBERS				
8EM2012	19020546	12	IR	65
8EM2012NA	19020546	12	IR	65
CARRIER PART NUMBERS				
30-00349-01	19020546	12	IR	65
30-00363-01	19020546	12	IR	65
30-00363-04	19020546	12	IR	65
30-00363-00	19020546	12	IR	65
30-00363-03	19020546	12	IR	65
30-00423-00	19020546	12	IR	65
30-50307-00	19020546	12	IR	65

Part Number	Reman Number	Volts	Reg	Amps
CUMMINS RECON PART NUMBER				
3675141RX	19020546	12	IR	65
DIXIE PART NUMBER				
A-9217	19020546	12	IR	65
LESTER PART NUMBER				
7344	19020546	12	IR	65
PRESTOLITE PART NUMBER				
110-379	19020546	12	IR	65
WILSON PART NUMBER				
90-05-9147	19020546	12	IR	65

Motorola 19020582



Part Number	Reman Number	Volts	Reg	Amps
DELCO REMY REMANUFACTURED PART NUMBER				
19020582	19020582	12	IR	72
MOTOROLA O.E. NUMBER				
8MR2058P	19020582	12	IR	72
DIXIE PART NUMBER				
A-9219	19020582	12	IR	72

Part Number	Reman Number	Volts	Reg	Amps
LESTER PART NUMBER				
7489	19020582	12	IR	72
PRESTOLITE PART NUMBERS				
110-309	19020582	12	IR	72
110-521	19020582	12	IR	72
THERMO KING PART NUMBER				
44-6981	19020582	12	IR	72
WILSON PART NUMBER				
90-05-9164	19020582	12	IR	72

REMANUFACTURED ALTERNATORS



Nippondenso 10459436



Does not include pulley

Part Number	Reman Number	Volts	Reg	Amps
DELCO REMY REMANUFACTURED PART NUMBER				
10459436	10459436	12	IR	110
NIPPONDENSO O.E. NUMBER				
101211-7811	10459436	12	IR	110

Part Number	Reman Number	Volts	Reg	Amps
ISUZU PART NUMBER				
8-97500-342-0	10459436	12	IR	110

Nippondenso 10459439



Note: Does not include pulley

Part Number	Reman Number	Volts	Reg	Amps
DELCO REMY REMANUFACTURED PART NUMBER				
10459439	10459439	12	IR	80
NIPPONDENSO O.E. NUMBER				
101211-1733	10459439	12	IR	80

Part Number	Reman Number	Volts	Reg	Amps
CHEV/GMC PART NUMBER				
94052181	10459439	12	IR	80
ISUZU PART NUMBER				
2-91255-922-0	10459439	12	IR	80

Nippondenso 10459440



Note: Does not include pulley

Part Number	Reman Number	Volts	Reg	Amps
DELCO REMY REMANUFACTURED PART NUMBER				
10459440	10459440	12	IR	65
NIPPONDENSO O.E. NUMBER				
100211-1721	10459440	12	IR	65
CHEV/GMC PART NUMBER				
94052179	10459440	12	IR	65
DIXIE PART NUMBER				
A-8253	10459440	12	IR	65

Part Number	Reman Number	Volts	Reg	Amps
ISUZU PART NUMBER				
2-91255-920-0	10459440	12	IR	65
LESTER PART NUMBER				
14737	10459440	12	IR	65
WILSON PART NUMBER				
90-29-5106	10459440	12	IR	65

Nippondenso 10459441



Note: Does not include pulley

Part Number	Reman Number	Volts	Reg	Amps
DELCO REMY REMANUFACTURED PART NUMBER				
10459441	10459441	12	IR	80
NIPPONDENSO O.E. NUMBER				
101211-6030	10459441	12	IR	80
CHEV/GMC PART NUMBER				
94052393	10459441	12	IR	80

Part Number	Reman Number	Volts	Reg	Amps
ISUZU PART NUMBER				
2-91123-212-0	10459441	12	IR	80
LESTER PART NUMBER				
12066	10459441	12	IR	80
WILSON PART NUMBER				
90-27-5095	10459441	12	IR	80

Nippondenso 10459442



Note: Does not include pulley

Part Number	Reman Number	Volts	Reg	Amps
DELCO REMY REMANUFACTURED PART NUMBER				
10459442	10459442	12	IR	55
NIPPONDENSO O.E. NUMBER				
100211-6020	10459442	12	IR	55

Part Number	Reman Number	Volts	Reg	Amps
CHEV/GMC PART NUMBER				
94052406	10459442	12	IR	55
ISUZU PART NUMBER				
2-91123-950-0	10459442	12	IR	55

Nippondenso 10459443



Note: Does not include pulley

Part Number	Reman Number	Volts	Reg	Amps
DELCO REMY REMANUFACTURED PART NUMBER				
10459443	10459443	12	IR	90
NIPPONDENSO O.E. NUMBER				
100211-5940	10459443	12	IR	90

Part Number	Reman Number	Volts	Reg	Amps
CHEV/GMC PART NUMBER				
94052407	10459443	12	IR	90
ISUZU PART NUMBER				
2-91123-214-0	10459443	12	IR	90

REMANUFACTURED ALTERNATORS



Nippondenso 10459444



Note: Does not include pulley

Part Number	Reman Number	Volts	Reg	Amps
DELCO Remy REMANUFACTURED PART NUMBER				
10459444	10459444	12	ER	50
NIPPONDENSO O.E. NUMBER				
121000-1680	10459444	12	ER	50
CHEV/GMC PART NUMBER				
94052405	10459444	12	ER	50

Part Number	Reman Number	Volts	Reg	Amps
LESTER PART NUMBER				
14736	10459444	12	ER	50
ISUZU PART NUMBER				
2-91123-932-0	10459444	12	ER	50

Nippondenso 10459445



Note: Does not include pulley

Part Number	Reman Number	Volts	Reg	Amps
DELCO Remy REMANUFACTURED PART NUMBER				
10459445	10459445	12	IR	65
NIPPONDENSO O.E. NUMBER				
100211-2750	10459445	12	IR	65
CHEV/GMC PART NUMBER				
94052185	10459445	12	IR	65
DIXIE PART NUMBER				
A-8269	10459445	12	IR	65

Part Number	Reman Number	Volts	Reg	Amps
ISUZU PART NUMBER				
2-91255-926-0	10459445	12	IR	65
LESTER PART NUMBER				
12082	10459445	12	IR	65
WILSON PART NUMBER				
90-29-5117	10459445	12	IR	65

Nippondenso 10459465



Note: Does not include pulley

Part Number	Reman Number	Volts	Reg	Amps
DELCO REMY REMANUFACTURED PART NUMBER				
10459465	10459465	12	IR	80
NIPPONDENSO O.E. NUMBER				
100211-2760	10459465	12	IR	80

Part Number	Reman Number	Volts	Reg	Amps
CHEV/GMC PART NUMBER				
94052183	10459465	12	IR	80
ISUZU PART NUMBER				
2-91255-924-0	10459465	12	IR	80

Nippondenso 10459494



Part Number	Reman Number	Volts	Reg	Amps
DELCO REMY REMANUFACTURED PART NUMBER				
10459494	10459494	12	IR	35
NIPPONDENSO O.E. NUMBERS				
100211-0940	10459494	12	IR	35
100211-0980	10459494	12	IR	35
DIXIE PART NUMBER				
A-8447	10459494	12	IR	35

Part Number	Reman Number	Volts	Reg	Amps
LESTER PART NUMBER				
12061	10459494	12	IR	35
WILSON PART NUMBER				
90-29-5119	10459494	12	IR	35

Nippondenso 10459495



Part Number	Reman Number	Volts	Reg	Amps
DELCO REMY REMANUFACTURED PART NUMBER				
10459495	10459495	12	IR	120
NIPPONDENSO O.E. NUMBERS				
100211-6030	10459495	12	IR	120
100211-6031	10459495	12	IR	120
100211-6050	10459495	12	IR	120
100211-6051	10459495	12	IR	120

Part Number	Reman Number	Volts	Reg	Amps
DIXIE PART NUMBER				
A-8284	10459495	12	IR	120
LESTER PART NUMBER				
12066	10459495	12	IR	120
WILSON PART NUMBER				
90-29-5095	10459495	12	IR	120

REMANUFACTURED ALTERNATORS



Nippondenso 10459507



Part Number	Reman Number	Volts	Reg	Amps
DELCO REMY REMANUFACTURED PART NUMBER				
10459507	10459507	12	ER	120
NIPPONDENSO O.E. NUMBERS				
121000-404	10459507	12	ER	120
121000-4040	10459507	12	ER	120

Part Number	Reman Number	Volts	Reg	Amps
LESTER PART NUMBER				
13301	10459507	12	ER	120
WILSON PART NUMBER				
90-29-5112	10459507	12	ER	120

Nippondenso 10459515



Part Number	Reman Number	Volts	Reg	Amps
DELCO REMY REMANUFACTURED PART NUMBER				
10459515	10459515	12	IR	55
NIPPONDENSO O.E. NUMBERS				
100211-6930	10459515	12	IR	55
100211-6931	10459515	12	IR	55
DIXIE PART NUMBER				
A-8449	10459515	12	IR	55

Part Number	Reman Number	Volts	Reg	Amps
LESTER PART NUMBER				
12184	10459515	12	IR	55
WILSON PART NUMBER				
90-29-5183	10459515	12	IR	55

Nippondenso 10459516



Part Number	Reman Number	Volts	Reg	Amps
DELCO REMY REMANUFACTURED PART NUMBER				
10459516	10459516	12	IR	35
NIPPONDENSO O.E. NUMBER				
100211-4540	10459516	12	IR	35
DIXIE PART NUMBER				
A-8282	10459516	12	IR	35

Part Number	Reman Number	Volts	Reg	Amps
LESTER PART NUMBER				
12187	10459516	12	IR	35
WILSON PART NUMBER				
90-29-5181	10459516	12	IR	35

Nippondenso 10459517



Part Number	Reman Number	Volts	Reg	Amps
DELCO REMY REMANUFACTURED PART NUMBER				
10459517	10459517	12	IR	140
NIPPONDENSO O.E. NUMBER				
100211-6420	10459517	12	IR	140
DIXIE PART NUMBER				
A-8496	10459517	12	IR	140

Part Number	Reman Number	Volts	Reg	Amps
LESTER PART NUMBER				
12195	10459517	12	IR	140
WILSON PART NUMBER				
90-29-5296	10459517	12	IR	140

Nippondenso 10459519



Part Number	Reman Number	Volts	Reg	Amps
DELCO REMY REMANUFACTURED PART NUMBER				
10459519	10459519	12	IR	90
NIPPONDENSO O.E. NUMBERS				
100211-0081	10459519	12	IR	90
100211-0290	10459519	12	IR	90
100211-0291	10459519	12	IR	90
100211-0292	10459519	12	IR	90

Part Number	Reman Number	Volts	Reg	Amps
DIXIE PART NUMBER				
A-890	10459519	12	IR	90
LESTER PART NUMBER				
13143	10459519	12	IR	90
WILSON PART NUMBER				
90-29-5036	10459519	12	IR	90

Nippondenso 10459521



Part Number	Reman Number	Volts	Reg	Amps
DELCO REMY REMANUFACTURED PART NUMBER				
10459521	10459521	12	ER	35
NIPPONDENSO O.E. NUMBER				
021000-6840	10459521	12	ER	35
DIXIE PART NUMBER				
A-8309	10459521	12	ER	35

Part Number	Reman Number	Volts	Reg	Amps
LESTER PART NUMBER				
14510	10459521	12	ER	35
WILSON PART NUMBER				
90-29-5096	10459521	12	ER	35

REMANUFACTURED ALTERNATORS



Nippondenso 10459532



Part Number	Reman Number	Volts	Reg	Amps
DELCO REMY REMANUFACTURED PART NUMBER				
10459532	10459532	12	ER	120
NIPPONDENSO O.E. NUMBERS				
121000-4000	10459532	12	ER	120
121000-4010	10459532	12	ER	120
121000-4030	10459532	12	ER	120
121000-4090	10459532	12	ER	120
121000-4100	10459532	12	ER	120
121000-4110	10459532	12	ER	120

Part Number	Reman Number	Volts	Reg	Amps
LESTER PART NUMBER				
13304	10459532	12	ER	120
WILSON PART NUMBER				
90-29-5111	10459532	12	ER	120

Nippondenso 10459544



Part Number	Reman Number	Volts	Reg	Amps
DELCO REMY REMANUFACTURED PART NUMBER				
10459544	10459544	12	ER	136
NIPPONDENSO O.E. NUMBERS				
121000-428	10459544	12	ER	136
121000-4280	10459544	12	ER	136

Part Number	Reman Number	Volts	Reg	Amps
DIXIE PART NUMBER				
A-8781	10459544	12	ER	136
LESTER PART NUMBER				
13766	10459544	12	ER	136

Prestolite 10459527



110-555 See page 55.

Part Number	Reman Number	Volts	Reg	Amps
DELCO REMY REMANUFACTURED PART NUMBER				
10459527	10459527	12	ER	34
PRESTOLITE O.E. NUMBER				
ALK6207	10459527	12	ER	34
DIXIE PART NUMBER				
MA-505	10459527	12	ER	34

Part Number	Reman Number	Volts	Reg	Amps
LESTER PART NUMBER				
7317	10459527	12	ER	34
WILSON PART NUMBER				
90-06-1020M	10459527	12	ER	34



Test Equipment Bench Top Tester

**Remy Approved
Test Equipment
To Reduce Your
Warranty Cost!**



FEATURES:

- Reduce Warranty Charge Backs
- Accurately Diagnoses Functional or Failed Units
- Reduce Vehicle Downtime

Will test alternators and generators up to 160 amps with integral or remote regulation.

Heavy duty starters can be free spun to test basic circuit integrity.

Designed for fast, simple operation.

Part No.	Description
10457728	5 H.P. 230 Volt Single Phase Motor
10457729	5 H.P. 230 Volt Three Phase Motor
10457771	5 H.P. 480 Volt Three Phase Motor



Master Rebuild Kit 50DN

Perfectly matched system components

EVERYTHING YOU NEED TO PUT NEW LIFE INTO YOUR 50DN ALTERNATORS!

**Only the Delco Remy
50DN Rebuild Kit:**

**Includes the Patented
Stator Lead Insulator
Meets OE specification
requirements**



**New stator
design featuring
Patented
New Stator
Lead Insulator**



The redesigned Delco Remy 50DN features an increased copper lead diameter along with the removal of the stator lead sleeves by utilizing the **Patented New Stator Lead Insulator** providing:

- Greater Oil Cooling
- Lead Ground and Shorting Prevention
- Increased Conductivity
- Easy Reassembly

Improved seal and collar features increased seal hardness and an optimized collar alignment along w/ new seal alignment tool results in:

- Oil Leakage Prevention
- Increased Wear Durability
- Confidence in Rebuild Quality

50DN Belt Drive Master Rebuild Kit Part# 10502551

Part#	Description	Qty.	Part#	Description	Qty.	Part#	Description	Qty.
1956315	Rotor	1	1941039	1/4" Sleeves	3	10475418	Cover	1
10504154	24V Belt Stator	1	1941041	1/4" O-Rings	9	10457643	Field Coil	1
1941057	O-Ring - Stator	1	1941043	1/2" O-Rings	3	10467805	Washers	3
1852224	Stator Nuts	6	10502988	Insulators	3	10502987	Rectifier Housing	1
1941057	O-Ring - Stator	1	1941055	1/2" Sleeve	1	10497129	Bolts, Attaching	6
30205	Washer	1	1952193	Studs	3	11506056*	1/4" Star Washers	4
112432*	10/32 Brass Nuts	3	1952212	Insltr Bushings	3	121339	Elbow	1
114548*	1/2" Brass Nut (B+)	1	1954711	Inserts	3	1941052	Bearing Clamp	1
181379*	Bolt, Field Coils	4	1965246	Bushing	1	10502031	Seal	1
422967*	1/2" Brass Jam Nut	1	1965249	Bushings	3	1956313	Gasket	1
423336*	Bolt, Diode Leads	4	1967036	Rectifier Plates	3	10500227	Collar	1
444861*	Pipe Plug	1	1967037	O-Ring - Cover	1	1958286	O-Ring	1
453326*	1/4-28 Nuts	6	1967038	DC Terminal	1	1970261	Washer, Shaft	1
455849*	10/3 Lockwashers	3	1974209	Ground Cntr	1	1979400	Nut, Shaft	1
1891955	Relay Terminal	1	1987256	Tee	1	1986263	Screw, Brng Retainer	6
1893813	Insulating Washer	1	9421423*	1/4" Lockwashers	3	1987333	Oil Line Bracket	1
1894867	Diodes	6	103321*	3/8" Lockwashers	4	1987651	Oil Line	1
1902746	Insulating Washers	3	9421427*	1/2" Lockwasher	1	9440138	Roller Bearing	1
1905125	1/4" Flat Washers	3	9439713*	1/2" Star Washer	1	10467191	Bracket Screw	2
1914472*	10/32 Brs Washers	3	10415784	Cover Bolts	7	10497129	Attaching Bolt	6
1970577*	Name Plate	1	1911126*	Rivet	2	10499878	Ball Bearing (13)	1

* Available in Master Rebuild Kit only.



Road Gang® Electrical System

Specify a Road Gang® Premium Electrical System on your new Class 8 Truck

3 Year-350,000 Mile

Free Replacement Warranty On All Alternator, Starter and LVD Components

Road Gang® Heavy Duty Alternator

All Road Gang® Premium Brushless Alternators come equipped with Remote Sense™ technology, which optimizes the charging system by directly monitoring battery conditions. Radiant vents and heat tolerant internal components deliver long-life in temperatures up to 105°C. Part Numbers: 19011260 (J180 Hinge Mount), 19011261 (QUAD Mount), 19011262 (PAD Mount)



Road Gang® Heavy Duty Starter

The Delco Remy Heavy Duty 42MT with Over Crank Protection (OCP) and our Patented Semi-Solid Link Solenoid (SSL) maintains longer starter life in most applications. OCP prevents damage to the starter caused by low voltage operator misuse. Part Numbers: 10479265, 10479267, 10479266



Road Gang® LVD (Low Voltage Disconnect)

Battery Management System designed to ensure that your batteries have enough power to start your vehicle, every time. The LVD switch cuts off nonessential loads when battery voltage gets too low. It prevents damage to components caused by low voltage conditions and reserves voltage for starting. Part #19020480

Road Gang® High Cycle Group 31 Batteries (4) – Free replacement 18 month/150,000 mile warranty

700CCA, and 180RC. Heavy duty leak proof case. Increased plate density assures cold weather starts and back up power during engine idle and off periods. Built in Hydrometer indicates state-of-charge at a glance.



- Exceeds TMC RP139 for cycling
- Exceeds TMC RP125 for vibration
- Top Stud Terminals for Optimum Corrosion Protection
- Longer Battery Life In Most Applications

4 - DR2150 Batteries



Road Gang® Replacement Components

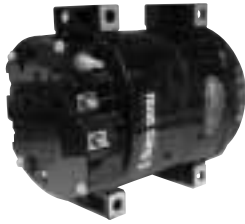

35SI

Genuine Road Gang® Replacement Alternators

OEM Number	Reman Number	Mounting	Volts	Amps
19011260	10459612	J180 Hinge Mount	12	135
19011261	10459613	Quad Mount	12	135
19011262	10459314	Pad Mount	12	135

33SI

OEM Number	Reman Number	OEM Number	Reman Number	Mount	Volts	Amps
35SI Upgrade						
19011200	10459450	19011260	10459612	35SI J180 Hinge Mount	12	135

34SI

OEM Number	Reman Number	OEM Number	Reman Number	Mount	Volts	Amps
35SI Upgrade						
19011201	10459451	19011261	10459613	35SI J180 Quad Mount	12	135
19011202	10459449	19011262	10459614	Pad Mount	12	135

With the 35SI upgrade program, you can convert any truck with a Road Gang® 33SI or 34SI to the new High Temperature 35SI model and receive full core credit for each 33SI and 34SI core returned. Effective 1/1/05, all 33SI, 34SI, and 35SI cores will be grouped by mounting style (J180 Hinge Mount, QUAD Mount, PAD Mount).



Genuine Road Gang® Replacement Starters with Over Crank Protection and Semi Solid Link Solenoid

OEM Number	Reman Number	Series	Volts	Pinion Teeth	Swp. Pos.	SAE Nose Hsg.
10479265	10462155	42MT OCP	12	11	082	03
10479266	10462196	42MT OCP	12	11	052	03
10479267	10462175	42MT OCP	12	11	088	03



Genuine Road Gang® Replacement LVD
OE#19020494 - New Service #10500389



Genuine Road Gang® Replacement 12 Volt Battery
Replacement #19049940

10MT



Part Number	Reman Number	Volts	Pinion Teeth	Switch Pos.	Mtg. Hole
DELCO REMY REMANUFACTURED PART NUMBERS					
10461597	10461597	12	9	80	.42
10461599	10461599	12	9	135	.42
10461600	10461600	12	10	136	.51
10461603	10461603	12	9	225	.42
10461605	10461605	12	9	280	.42
10461606	10461606	12	9	235	.42
10461611	10461611	12	10	231	.47
10461612	10461612	12	9	80	.42
10461613	10461613	12	9	235	.42
10461617	10461617	12	10	136	.43
10461620	10461620	12	10	120	.43
10461624	10461624	12	9	—	.55
10461625	10461625	12	9	—	.42
10461629	10461629	12	10	—	.42
10461649	10461649	12	9	—	.47
10461661	10461661	6	9	—	.47
10461662	10461662	12	9	—	.47
10461668	10461668	12	9	—	.47
10461669	10461669	12	9	—	.47
10461671	10461671	12	9	280	
10461677	10461677	12	11	300	.47
10461696	10461696	6	10	—	.47
10461700	10461700	6	9	—	.47
10461701	10461701	12	9	—	.42
10465060	10465060	12	9	80	.42
10465152	10465152	12	9	125	.48
10465153	10465153	12	9	146	.43
10465154	10465154	12	9	146	.43
10465155	10465155	12	9	100	.40
10465157	10465157	12	9	180	.50
10465158	10465158	12	9	126	.48
10465171	10465171	12	9	100	.42
10465352	10465352	12	9	230	.42
10465409	10465409	12	9	136	.52
10465410	10465410	12	10	225	.42
10465411	10465411	12	10	120	.42
10465412	10465412	12	10	235	.42
10465413	10465413	12	9	280	.42
10465414	10465414	12	9	135	.42
10465415	10465415	12	10	135	.42
10465416	10465416	12	10	135	.42
10465418	10465418	12	9	250	.42
10465419	10465419	12	9	165	.56

DELCO REMY O.E. PART NUMBERS

1107001	10461700	6	9	—	.47
1107009	10461700	6	9	—	.47
1107033	10461700	6	9	—	.47
1107047	10461700	6	9	—	.47

Part Number	Reman Number	Volts	Pinion Teeth	Switch Pos.	Mtg. Hole
DELCO REMY O.E. PART NUMBERS (CONT.)					
1107054	10461700	6	9	—	.47
1107055	10461700	6	9	—	.47
1107061	10461700	6	9	—	.47
1107103	10461700	6	9	—	.47
1107108	10461700	6	9	—	.47
1107204	10461606	12	9	235	.42
1107215	10461612	12	9	80	.42
1107226	10461649	12	9	—	.47
1107227	10461701	12	9	—	.42
1107245	10461597	12	9	80	.42
1107249	10461617	12	10	136	.43
1107295	10461606	12	9	235	.42
1107300	10461611	12	10	231	.47
1107308	10461603	12	9	225	.42
1107350	10461613	12	9	235	.42
1107356	10461669	12	9	—	.47
1107377	10461605	12	9	280	.42
1107378	10461605	12	9	280	.42
1107382	10461611	12	10	231	.47
1107386	10461599	12	9	135	.42
1107398	10465060	12	9	80	.42
1107399	10461600	12	10	136	.51
1107427	10461696	6	10	—	.47
1107448	10461696	6	10	—	.47
1107627	10461625	12	9	—	.42
1107640	10461625	12	9	—	.42
1107645	10461625	12	9	—	.42
1107649	10461625	12	9	—	.42
1107654	10465158	12	9	126	.48
1107670	10461625	12	9	—	.42
1107678	10461624	12	9	—	.55
1107679	10461624	12	9	—	.55
1107695	10461668	12	9	—	.47
1107726	10461649	12	9	—	.47
1107758	10461671	12	9	280	
1107785	10461613	12	9	235	.42
1107885	10461612	12	9	80	.42
1108284	10461620	12	10	120	.43
1108290	10461612	12	9	80	.42
1108319	10461600	12	10	136	.51
1108388	10461617	12	10	136	.43
1108390	10461620	12	10	120	.43
1108394	10461677	12	11	300	.47
1108421	10461613	12	9	235	.42
1108423	10461606	12	9	235	.42
1108438	10461613	12	9	235	.42
1108494	10461613	12	9	235	.42
1108508	10461603	12	9	225	.42
1108769	10465158	12	9	126	.48

REMANUFACTURED STARTERS



10MT (cont.)

Part Number	Reman Number	Volts	Pinion Teeth	Switch Pos.	Mtg. Hole
DELCO REMY O.E. PART NUMBERS (CONT.)					
1109053	10461597	12	9	80	.42
1109055	10465060	12	9	80	.42
1109085	10465060	12	9	80	.42
1109086	10461597	12	9	80	.42
1109087	10461603	12	9	225	.42
1109090	10461605	12	9	280	.42
1109091	10461605	12	9	280	.42
1109095	10461606	12	9	235	.42
1109420	10461617	12	10	136	.43
1109421	10461600	12	10	136	.51
1109424	10461599	12	9	135	.42
1109436	10461611	12	10	231	.47
1109438	10461612	12	9	80	.42
1109457	10461661	6	9	-	.47
1109576	10461600	12	10	136	.51
1998252	10465158	12	9	126	.48
1998262	10461597	12	9	80	.42
1998281	10465352	12	9	230	.42
1998293	10461629	12	10	-	.42
1998299	10461599	12	9	135	.42
1998313	10465419	12	9	165	.56
1998391	10465409	12	9	136	.42
1998485	10465410	12	10	225	.42
1998576	10465411	12	10	120	.42
1998599	10465157	12	9	180	.50
10455305	10465155	12	9	100	.40
10455309	10465152	12	9	125	.48
10455310	10465153	12	9	146	.43
10455311	10465154	12	9	146	.43
10455326	10465412	12	10	235	.42
10455333	10465413	12	9	280	.42
10455336	10465414	12	9	135	.42
10455337	10465415	12	10	135	.42
10455339	10465416	12	10	135	.42
10455340	10465352	12	9	230	.42
10455341	10465418	12	9	250	.42
10455347	10465409	12	9	136	.52
10455348	10465410	12	10	225	.42
10455349	10465411	12	10	120	.42
10455350	10465412	12	10	235	.42
10455351	10465413	12	9	280	.42
10455352	10465414	12	9	135	.42
10455353	10465415	12	10	135	.42
10455354	10465416	12	10	135	.42
10455355	10465352	12	9	230	.42
10455356	10465418	12	9	250	.42
10455357	10465419	12	9	165	.56
10465108	10465171	12	9	100	.42
10465157	10465158	12	9	126	.48
10465417	10465352	12	9	230	.42
10465423	10465409	12	9	136	.52
10465424	10465410	12	10	225	.42
10465425	10465411	12	10	120	.42
10465426	10465412	12	10	235	.42
10465427	10465413	12	9	280	.42
10465428	10465414	12	9	135	.42

Part Number	Reman Number	Volts	Pinion Teeth	Switch Pos.	Mtg. Hole
DELCO REMY O.E. PART NUMBERS (CONT.)					
10465429	10465415	12	10	135	.42
10465430	10465416	12	10	135	.42
10465431	10465352	12	9	230	.42
10465432	10465418	12	9	250	.42
10465433	10465419	12	9	165	.56
10465449	10465412	12	10	235	.42
10465450	10465415	12	10	135	.42

AC DELCO CATALOG NUMBERS

323-255	10465171	12	9	100	.42
323-484	10465153	12	9	146	.43
323-631	10461613	12	9	235	.42
323-632	10461605	12	9	280	.42
323-633	10461599	12	9	135	.42
323-636	10461606	12	9	235	.42
323-639	10461612	12	9	80	.42
323-645	10461603	12	9	225	.42
323-648	10461620	12	10	120	.42
323-651	10461597	12	9	80	.42
323-652	10461600	12	10	136	.42
323-653	10461611	12	10	231	.47
323-655	10461617	12	10	136	.43
323-1193	10465409	12	9	136	.52
323-1194	10465410	12	10	225	.42
323-1195	10465411	12	10	120	.42
323-1196	10465412	12	10	235	.42
323-1197	10465413	12	9	280	.42
323-1198	10465414	12	9	135	.42
323-1199	10465415	12	10	135	.42
323-1200	10465416	12	10	135	.42
323-1201	10465352	12	9	230	.42
323-1202	10465418	12	9	250	.42
323-1203	10465419	12	9	165	.56

BERMAN PART NUMBERS

DS-01	10465155	12	9	100	.40
DS-26	10465411	12	10	120	.42
DS-44	10465419	12	9	165	.56

CARGO PART NUMBERS

110469	10465352	12	9	230	.42
111049	10465411	12	10	120	.42
111260	10465419	12	9	165	.56

DIXIE PART NUMBERS

S-1009	10461700	6	9	-	.47
S-1043	10465419	12	9	165	.56
S-1060	10461624	12	9	-	.55
S-1172	10465154	12	9	146	.43
S-1181	10465153	12	9	146	.43
S-1182	10465152	12	9	125	.42
S-1251	10465158	12	9	126	.48
S-1388	10465155	12	9	100	.40
S-1443	10461625	12	9	-	.48

Remanufactured Starters

REMANUFACTURED STARTERS

10MT (cont.)

Part Number	Reman Number	Volts	Pinion Teeth	Switch Pos.	Mtg. Hole	Part Number	Reman Number	Volts	Pinion Teeth	Switch Pos.	Mtg. Hole
DIXIE PART NUMBERS (CONT.)						WILSON PART NUMBERS					
TS-1004	10461696	6	10	—	.47	91-01-3639	10461696	6	10	—	.47
TS-1014	10461668	12	9	—	.47	91-01-3646	10461700	6	9	—	.47
TS-1048	10461671	12	9	280		91-01-3659	10461668	12	9	—	.42
TS-1051	10461701	12	9	—	.42	91-01-3682	10461625	12	9	—	.42
TS-1087	10461613	12	9	235	.42	91-01-3736	10461624	12	9	—	.42
TS-1126	10461649	12	9	—	.47	91-01-3832	10465153	12	9	146	.43
TS-1153	10461612	12	9	80	.42	91-01-3853	10465158	12	9	126	.48
TS-1161	10461606	12	9	235	.42	91-01-3865	10465154	12	9	146	.43
TS-1168	10461669	12	9	—	.47	91-01-3882	10465155	12	9	100	.40
TS-1172	10461600	12	10	136	.51	91-01-3940	10461671	12	9	280	
TS-1226	10461599	12	9	135	.42	91-01-3942	10461701	12	9	—	.42
TS-1227	10461597	12	9	80	.42	91-01-3967	10461613	12	9	235	.42
TS-1239	10461605	12	9	280	.42	91-01-3996	10461649	12	9	—	.47
TS-1242	10461611	12	10	231	.47	91-01-4021	10461612	12	9	80	.42
TS-1245	10461620	12	10	120	.43	91-01-4025	10461606	12	9	235	.42
TS-1262	10461677	12	11	300	.47	91-01-4032	10461669	12	9	—	.47
TS-1283	10461603	12	9	225	.42	91-01-4036	10461600	12	10	136	.51
TS-1306A	10465060	12	9	80	.42	91-01-4176	10461599	12	9	135	.42
TS-1322	10461617	12	10	136	.43	91-01-4177	10461597	12	9	80	.42
TS-1326	10461629	12	10	—	.42	91-01-4188	10461605	12	9	280	.42
TS-1366	10465411	12	10	120	.42	91-01-4191	10461611	12	10	231	.47
TS-1377	10461661	6	9	—	.42	91-01-4194	10461620	12	10	120	.43
TS-1557	10465410	12	10	225	.42	91-01-4201	10461677	12	11	300	.47
TS-1559	10465158	12	9	126	.48	91-01-4203	10461603	12	9	225	.42
TS-1617	10465409	12	9	136	.42	91-01-4216	10461617	12	10	136	.43
TS-1631	10465352	12	9	230	.42	91-01-4225	10465158	12	9	126	.48
						91-01-4247	10465352	12	9	230	.42
						91-01-4248	10461629	12	10	—	.42
						91-01-4273	10465410	12	10	225	.42
						91-01-4274	10465411	12	10	120	.42
						91-01-4281	10465409	12	9	136	.52
						91-01-4432	10465412	12	10	235	.42
						91-01-4848	10461661	6	9	—	.47
MIDLAND PART NUMBERS											
RS110002X	10465158	12	9	126	.48						
RS110004X	10465158	12	9	126	.48						
RS110010X	10465155	12	9	100	.40						
RS110011X	10465158	12	9	126	.48						
RS110012X	10465154	12	9	146	.43						
RS110031X	10465153	12	9	146	.43						
RS110033X	10465152	12	9	125	.48						
RS110035X	10465352	12	9	230	.42						

REMANUFACTURED STARTERS



20, 22, 25MT



Part Number	Reman Number	Series	Volts	Pinion Teeth	Switch Pos.	Mtg. Hole
DELCO REMY REMANUFACTURED PART NUMBERS						
10461598	10461598	20MT	12	10	135	.47
10461602	10461602	20MT	12	9	235	.41
10461609	10461609	20MT	12	10	120	.41
10461610	10461610	20MT	12	10	120	.41
10461615	10461615	20MT	12	9	235	.41
10461616	10461616	20MT	12	10	207	.41
10461672	10461672	22MT	12	10	120	.41
10461673	10461673	22MT	12	10	120	.41
10461678	10461678	25MT	12	10	136	.41
10461697	10461697	25MT	12	9	105	.41
10461698	10461698	25MT	12	9	105	.41

Part Number	Reman Number	Series	Volts	Pinion Teeth	Switch Pos.	Mtg. Hole
DELCO REMY PART NUMBERS						
1107512	10461598	20MT	12	10	135	.47
1107522	10461615	20MT	12	9	235	.41
1107546	10461615	20MT	12	9	235	.41
1107550	10461697	25MT	12	9	105	.41
1107557	10461616	20MT	12	10	207	.41
1107578	10461615	20MT	12	9	235	.41
1107582	10461616	20MT	12	10	207	.41
1107583	10461598	20MT	12	10	135	.47
1107782	10461602	20MT	12	9	235	.41
1107853	10461598	20MT	12	10	135	.47
1107860	10461598	20MT	12	10	135	.47
1107870	10461598	20MT	12	10	135	.47
1108251	10461697	25MT	12	9	105	.41
1108665	10461615	20MT	12	9	235	.41
1108675	10461615	20MT	12	9	235	.41
1109143	10461609	20MT	12	10	120	.41
1109145	10461615	20MT	12	9	235	.41
1109149	10461610	20MT	12	10	120	.41
1109190	10461610	20MT	12	10	120	.41
1109251	10461678	25MT	12	10	136	.41
1109256	10461698	25MT	12	9	105	.41
1109426	10461602	20MT	12	9	235	.41
1998337	10461616	20MT	12	10	207	.41
1998352	10461615	20MT	12	9	235	.41
1998353	10461673	22MT	12	10	120	.41
1998505	10461672	22MT	12	10	120	.41

Part Number	Reman Number	Series	Volts	Pinion Teeth	Switch Pos.	Mtg. Hole
AC DELCO CATALOG NUMBERS						
323-642	10461602	20MT	12	9	235	.41
323-673	10461598	20MT	12	10	135	.47
323-675	10461616	20MT	12	10	207	.41
323-677	10461609	20MT	12	10	120	.41
323-681	10461615	20MT	12	9	235	.41
323-692	10461610	20MT	12	10	120	.41
323-695	10461678	25MT	12	10	136	.41

Part Number	Reman Number	Series	Volts	Pinion Teeth	Switch Pos.	Mtg. Hole
DIXIE PART NUMBERS						
S-1080	10461697	25MT	12	9	105	.41
S-1266	10461698	25MT	12	9	105	.41
TS-1036	10461598	20MT	12	10	135	.47
TS-1088	10461615	20MT	12	9	235	.41
TS-1195	10461616	20MT	12	10	207	.41
TS-1294	10461609	20MT	12	10	120	.41
TS-1331	10461602	20MT	12	9	235	.41
TS-1308	10461678	25MT	12	10	136	.41

Part Number	Reman Number	Series	Volts	Pinion Teeth	Switch Pos.	Mtg. Hole
WILSON PART NUMBERS						
91-01-3693	10461598	20MT	12	10	135	.47
91-01-3760	10461697	25MT	12	9	105	.41
91-01-3799	10461698	25MT	12	9	105	.41
91-01-3968	10461615	20MT	12	9	235	.41
91-01-4054	10461616	20MT	12	10	207	.41
91-01-4094	10461610	20MT	12	10	120	.41
91-01-4096	10461609	20MT	12	10	120	.41
91-01-4215	10461678	25MT	12	10	136	.41
91-01-4219	10461602	20MT	12	9	235	.41

Remanufactured Starters

REMANUFACTURED STARTERS

27MT



Part Number	Reman Number	Volts	Pinion Teeth	Switch Pos.	Mtg. Hole
DELCO REMY REMANUFACTURED PART NUMBERS					
10461070	10461070	12	10	165	.41
10465149	10465149	12	10	135	.43
10465347	10465347	12	10	136	.48
10465351	10465351	12	10	225	.42

Part Number	Reman Number	Volts	Pinion Teeth	Switch Pos.	Mtg. Hole
DELCO REMY O.E. PART NUMBERS					
1113593	10465149	12	10	135	.43
1988708	10465149	12	10	135	.43
1998367	10465347	12	10	136	.48
1998379	10465351	12	10	225	.42
1998418	10461070	12	10	165	.41
1998423	10465149	12	10	135	.43
1998456	10465149	12	10	135	.43
1998457	10465149	12	10	135	.43
1998490	10465149	12	10	135	.43

Part Number	Reman Number	Volts	Pinion Teeth	Switch Pos.	Mtg. Hole
AC DELCO CATALOG NUMBERS					
323-278	10461070	12	10	165	.41
323-823	10465149	12	10	135	.43
323-826	10465347	12	10	136	.48

Part Number	Reman Number	Volts	Pinion Teeth	Switch Pos.	Mtg. Hole
BERMAN PART NUMBER					
DS-45	10465149	12	10	135	.43

Part Number	Reman Number	Volts	Pinion Teeth	Switch Pos.	Mtg. Hole
CARGO PART NUMBERS					
110603	10465149	12	10	135	.43
111221	10465347	12	10	136	.48

Part Number	Reman Number	Volts	Pinion Teeth	Switch Pos.	Mtg. Hole
CUMMINS RECON PART NUMBER					
604482RX	10465149	12	10	135	.43

Part Number	Reman Number	Volts	Pinion Teeth	Switch Pos.	Mtg. Hole
DIXIE PART NUMBERS					
TS-1267	10465149	12	10	135	.43
TS-1308	10465347	12	10	136	.48
TS-1582	10461070	12	10	165	.41

Part Number	Reman Number	Volts	Pinion Teeth	Switch Pos.	Mtg. Hole
MIDLAND PART NUMBER					
RS127000X	10465149	12	10	135	.43

Part Number	Reman Number	Volts	Pinion Teeth	Switch Pos.	Mtg. Hole
WILSON PART NUMBERS					
91-01-3894	10465149	12	10	135	.43
91-01-4037	10465347	12	10	136	.48
91-01-4275	10461070	12	10	165	.41

28MT



Part Number	Reman Number	Volts	Pinion Teeth	Switch Pos.	Mtg. Hole
DELCO REMY REMANUFACTURED PART NUMBERS					
10461443	10461443	12	10	316	.48
10461444	10461444	24	10	316	.48
10461445	10461445	12	12	300	.41
10461446	10461446	12	10	315	.41
10461447	10461447	12	10	315	.41
10461448	10461448	12	12	055	.41
10461449	10461449	12	12	055	.41
10461450	10461450	12	10	055	.41
10461451	10461451	12	10	055	.41
10461452	10461452	12	10	070	.41
10461453	10461453	24	10	304	.41
10461454	10461454	12	9	233	.41
10461459	10461459	24	12	055	.41
10461460	10461460	12	10	300	.41
10461461	10461461	24	10	315	.41

Part Number	Reman Number	Volts	Pinion Teeth	Switch Pos.	Mtg. Hole
DELCO REMY REMANUFACTURED PART NUMBERS (CONT.)					
10461463	10461463	12	10	300	.41
10461464	10461464	24	10	300	.41
10461465	10461465	24	10	315	.41
10461466	10461466	12	10	315	.41
10461467	10461467	12	9	055	.41
10461468	10461468	24	10	315	.41
10461469	10461469	24	10	315	.41
10461470	10461470	24	9	233	.41
10461471	10461471	12	10	316	.48
10461472	10461472	24	10	055	.41
10461473	10461473	12	10	316	.48
10461474	10461474	12	10	315	.41
10461475	10461475	12	10	315	.41
10461476	10461476	12	9	233	.41
10461477	10461477	12	10	055	.41

REMANUFACTURED STARTERS



28MT (cont.)

Part Number	Reman Number	Volts	Pinion Teeth	Switch Pos.	Mtg. Hole
DELCO REMY REMANUFACTURED PART NUMBERS (CONT.)					
10461478	10461478	24	9	233	.41
10461479	10461479	12	10	315	.41
10461480	10461480	12	10	055	.41
10461481	10461481	12	10	315	.41
10461482	10461482	12	10	316	.48
10461483	10461483	12	10	120	.41
10461484	10461484	12	10	045	.41
10461485	10461485	12	10	300	.41
10461486	10461486	24	10	315	.41
10461487	10461487	12	10	070	.41
10465043	10465043	12	10	315	.41
10465150	10465150	12	10	120	.41
10465151	10465151	12	10	55	.41
10465168	10465168	12	10	304	.45
10465239	10465239	12	10	45	.41
10465295	10465295	12	10	300	.41
10465296	10465296	12	10	304	.41
10465315	10465315	12	9	55	.41
10465348	10465348	12	12	300	.41
10465349	10465349	12	10	55	.41
10465365	10465365	12	10	315	.41

DELCO REMY O.E. PART NUMBERS

1107577	10461443	12	10	316	.48
1107599	10461443	12	10	316	.48
1107863	10461443	12	10	316	.48
1107871	10461443	12	10	316	.48
1109496	10465315	12	12	55	.41
1113266	10465296	12	12	304	.41
1113267	10465168	12	12	304	.45
1113269	10465296	12	12	304	.41
1113270	10465168	12	12	304	.45
1113271	10461443	12	10	316	.48
1113272	10461444	24	10	316	.48
1113273	10461445	12	12	300	.41
1113274	10465295	12	12	300	.41
1113275	10461446	12	10	315	.41
1113276	10465043	12	12	315	.41
1113277	10461468	24	10	315	.41
1113278	10461447	12	10	315	.41
1113279	10461448	12	12	055	.41
1113280	10461449	12	12	055	.41
1113281	10461450	12	10	055	.41
1113282	10461451	12	10	055	.41
1113283	10461482	12	12	316	.48
1113284	10461483	12	12	120	.41
1113285	10465349	12	12	55	.41
1113286	10465315	12	12	55	.41
1113287	10461452	12	10	070	.41
1113288	10461484	12	12	045	.41
1113289	10465239	12	12	45	.41
1113290	10461485	12	12	300	.41
1113291	10461486	24	24	315	.41
1113292	10465365	12	12	315	.41
1113295	10465296	12	12	304	.41
1113296	10465168	12	12	304	.45
1113297	10461487	12	12	070	.41

Part Number	Reman Number	Volts	Pinion Teeth	Switch Pos.	Mtg. Hole
DELCO REMY O.E. PART NUMBERS (CONT.)					
1998380	10465315	12	12	55	.41
10461285	10465365	12	12	315	.41
10465013	10465296	12	12	304	.41
10465014	10465168	12	12	304	.45
10465403	10465043	12	12	315	.41
10465404	10465365	12	12	315	.41
10465407	10465043	12	12	315	.41
10465408	10465239	12	12	45	.41
10479600	10461459	24	12	055	.41
10479604	10461460	12	10	300	.41
10479605	10461461	24	10	315	.41
10479607	10461463	12	10	300	.41
10479608	10461464	24	10	300	.41
10479611	10461453	24	10	304	.41
10479613	10465348	12	12	300	.41
10479614	10465150	12	12	120	.41
10479615	10465151	12	12	55	.41
10479616	10461465	24	10	315	.41
10479617	10461466	12	10	315	.41
10479618	10465151	12	12	55	.41
10479619	10461452	12	10	070	.41
10479620	10461467	12	9	055	.41
10479621	10465043	12	12	315	.41
10479622	10461468	24	10	315	.41
10479623	10461469	24	10	315	.41
10479624	10465365	12	12	315	.41
10479625	10465151	12	12	55	.41
10479626	10461470	24	9	233	.41
10479628	10461471	12	10	316	.41
10479629	10461472	24	10	055	.41
10479630	10461473	12	10	316	.41
10479634	10461474	12	12	315	.41
10479636	10461475	12	12	315	.41
10479637	10461476	12	12	233	.41
10479638	10461477	12	12	055	.41
10479639	10461478	24	12	233	.41
10479640	10461479	12	12	315	.41
10479641	10461480	12	12	055	.41
10479642	10461481	12	12	315	.41
10479643	10461479	12	12	315	.41
10479644	10461480	12	12	055	.41
10479645	10461454	12	9	233	.41

AC DELCO CATALOG NUMBERS

323-408	10461453	24	10	304	.41
323-419	10465043	12	12	315	.41
323-437	10465295	12	12	300	.41
323-438	10461446	12	10	315	.41
323-439	10461447	12	10	315	.41
323-440	10461448	12	12	055	.41
323-442	10461450	12	10	055	.41
323-446	10465296	12	12	304	.41
323-447	10465168	12	12	304	.41
323-448	10465315	12	12	55	.41
323-450	10461487	12	12	070	.41
323-451	10461445	12	12	300	.41
323-482	10465239	12	12	45	.41

Remanufactured Starters

28MT (cont.)

Part Number	Reman Number	Volts	Pinion Teeth	Switch Pos.	Mtg. Hole
AC DELCO CATALOG NUMBERS (CONT.)					
323-486	10461452	12	10	070	.41
323-487	10465365	12	12	315	.41
323-504	10465151	12	12	55	.41
323-833	10465315	12	12	55	.41
323-911	10461468	24	10	315	.41
323-984	10461443	12	10	316	.48
323-1187	10465349	12	12	55	.41
323-1188	10465150	12	12	120	.41
323-1189	10465348	12	12	300	.41

BERMAN PART NUMBERS					
DS-48	10465043	12	12	315	.41
DS-49	10461450	12	10	055	.41
DS-50	10465151	12	12	55	.41
DS-52	10465168	12	12	304	.45
DS-55	10461446	12	10	315	.41
DS-62	10465348	12	12	300	.41

CARGO PART NUMBERS					
110590	10461450	12	10	055	.41
110603	10465043	12	12	315	.41
111038	10465348	12	12	300	.41
111041	10461446	12	10	315	.41
111221	10461443	12	10	316	.48
111222	10461484	12	12	045	.41
111255	10465295	12	12	300	.41
111256	10465168	12	12	304	.45
111383	10465349	12	12	55	.41

CUMMINS RECON PART NUMBERS					
3575130RX	10461483	12	12	120	.41
3604654RX	10465043	12	12	315	.41
3604677RX	10461486	24	24	315	.41
3675130RX	10461483	12	12	120	.41
3675172RX	10465151	12	12	55	.41
3675173RX	10465150	12	12	120	.41
3604654RX	10465365	12	12	315	.41
3675172RX	10465151	12	12	55	.41
3916854RX	10465043	12	12	315	.41
3918376RX	10465365	12	12	315	.41

DDC CATALOG NUMBERS					
R0461446	10461446	12	10	315	.41
R0465406	10461446	12	10	315	.41
R0465407	10465043	12	12	315	.41
R0465408	10465239	12	12	45	.41

DDC PART NUMBERS					
R0461446	10461446	12	10	315	.41
R0465406	10461446	12	10	315	.41
R0465407	10465043	12	12	315	.41
R0465408	10465239	12	12	45	.41

DIXIE PART NUMBERS					
S-8212	10465296	12	12	304	.41
S-8213	10465168	12	12	304	.45
TS-1436	10465315	12	12	55	.41
TS-1572	10461450	12	10	055	.41

Part Number	Reman Number	Volts	Pinion Teeth	Switch Pos.	Mtg. Hole
DIXIE PART NUMBERS (CONT.)					
TS-1573	10465315	12	12	55	.41
TS-1574	10461443	12	10	316	.48
TS-1575	10461445	12	12	300	.41
TS-1576	10465295	12	12	300	.41
TS-1578	10465043	12	12	315	.41
TS-1579	10461446	12	10	315	.41
TS-1580	10461448	12	12	055	.41
TS-1581	10461452	12	10	070	.41
TS-1582	10465239	12	12	45	.41
TS-1584	10461487	12	12	070	.41
TS-1602	10461468	24	10	315	.41
TS-1618	10461485	12	12	300	.41
TS-1619	10461461	24	10	315	.41
TS-1620	10461460	12	10	300	.41
TS-1621	10465365	12	12	315	.41
TS-1622	10461486	24	24	315	.41
TS-1623	10461484	12	12	045	.41
TS-1624	10461459	24	12	055	.41
TS-1625	10465151	12	12	55	.41
TS-1626	10465150	12	12	120	.41
TS-1627	10465348	12	12	300	.41
TS-1633	10465349	12	12	55	.41
TS-1639	10461453	24	10	304	.41
TS-1640	10461444	24	10	316	.48
TS-1641	10461464	24	10	300	.41
TS-1642	10461465	24	10	315	.41
TS-1644	10461463	12	10	300	.41
TS-1645	10461471	12	10	316	.48
TS-1646	10461482	12	12	316	.48
TS-1647	10461467	12	9	055	.41
TS-1649	10461466	12	10	315	.41
TS-1660	10461472	24	10	055	.41

MIDLAND PART NUMBERS					
RS128000X	10465043	12	12	315	.41
RS128002X	10465365	12	12	315	.41
RS128010X	10465150	12	12	120	.41
RS128011X	10465151	12	12	55	.41
RS128012X	10465168	12	12	304	.41
RS128013X	10465239	12	12	45	.41
RS128014X	10465295	12	12	300	.41
RS128015X	10465296	12	12	304	.41
RS128016X	10465315	12	12	55	.41
RS128017X	10465349	12	12	55	.41
RS128018X	10465348	12	12	300	.41

WILSON PART NUMBERS					
91-01-3926	10465296	12	12	304	.41
91-01-3927	10465168	12	12	304	.45
91-01-4271	10465315	12	12	55	.41
91-01-4309	10461445	12	12	300	.41
91-01-4310	10461450	12	10	055	.41
91-01-4311	10465295	12	12	300	.41
91-01-4312	10461446	12	10	315	.41
91-01-4313	10465043	12	12	315	.41
91-01-4314	10461448	12	12	055	.41
91-01-4315	10465315	12	12	55	.41
91-01-4316	10461452	12	10	070	.41

REMANUFACTURED STARTERS



28MT (cont.)

Part Number	Reman Number	Volts	Pinion Teeth	Switch Pos.	Mtg. Hole	Part Number	Reman Number	Volts	Pinion Teeth	Switch Pos.	Mtg. Hole
WILSON PART NUMBERS (CONT.)						WILSON PART NUMBERS (CONT.)					
91-01-4317	10461487	12	12	070	.41	91-01-4371	10465348	12	12	300	.41
91-01-4354	10465150	12	12	120	.41	91-01-4374	10461467	12	9	055	.41
91-01-4356	10465151	12	12	55	.41	91-01-4375	10465349	12	12	55	.41
91-01-4361	10461468	24	10	315	.41	91-01-4377	10461444	24	10	316	.48
91-01-4362	10461473	12	10	316	.48	91-01-4378	10465239	12	12	45	.41
91-01-4363	10461484	12	12	045	.41	91-01-4381	10461466	12	10	315	.41
91-01-4364	10461485	12	12	300	.41	91-01-4414	10461483	12	12	120	.41
91-01-4365	10461486	24	24	315	.41	91-01-4415	10461463	12	10	300	.41
91-01-4366	10465365	12	12	315	.41	91-01-4416	10461464	24	10	300	.41
91-01-4367	10461443	12	10	316	.41	91-01-4417	10461453	24	10	304	.41
91-01-4368	10461459	24	12	055	.41	91-01-4418	10461465	24	10	315	.41
91-01-4369	10461460	12	10	300	.41	91-01-4419	10461471	12	10	316	.48
91-01-4370	10461461	24	10	315	.41	91-01-4552	10461472	24	10	055	.41

29MT



Part Number	Reman Number	Volts	Pinion Teeth	Switch Pos.	Mtg. Hole	Nose Hsg.	Part Number	Reman Number	Volts	Pinion Teeth	Switch Pos.	Mtg. Hole	Nose Hsg.
DELCO REMY REMANUFACTURED PART NUMBERS							DELCO REMY O.E. PART NUMBERS (CONT.)						
10461764	10461764	12	10	055	.39	01	8200067	10461771	12	10	055	.43	01
10461765	10461765	12	10	315	.39	01	19011400	10461770	12	10	315	.43	01
10461770	10461770	12	10	315	.43	01	19011402	10461771	12	10	055	.43	01
10461771	10461771	12	10	055	.43	01	19011403	10461772	12	9	315	.43	01
10461772	10461772	12	9	315	.43	01	19011404	10461764	12	10	055	.39	01
DELCO REMY O.E. PART NUMBERS							19011407	10461764	12	10	055	.39	01
8200010	10461770	12	10	315	.43	01	19011409	10461765	12	10	315	.39	01
8200011	10461772	12	9	315	.43	01							

37MT



SAE No 1 Flange
180° Flywheel Opening



SAE No 1 Flange
215° Flywheel Opening



SAE No 3 Flange
180° Flywheel Opening

Remarks

- Commutator End Rotated 180°
- Solenoid Terminals Reversed
- 145° Nose Housing Opening
- Offset Nose Housing
- Ground Stud in Frame
- 3/8" Battery Terminal
- Special Battery Terminal
- 215° Nose Housing
- Nose Piece w/15° Mounting Pos. Offset by 7-1/2°
- Special Lever Housing
- Special Commutator End
- Provisions for Mounting Shield

Note:

* overcrank protection - OCP
insulated

Part Number	Reman Number	Volts	Pinion Teeth	Switch Pos.	Mtg. Hole	Nose Hsg.	Rem.	Part Number	Reman Number	Volts	Pinion Teeth	Switch Pos.	Mtg. Hole	Nose Hsg.	Rem.
DELCO REMY REMANUFACTURED PART NUMBERS								DELCO REMY REMANUFACTURED PART NUMBERS (CONT.)							
10461001	10461001	12	10	038	.42	01	-	10461010	10461010	12	12	030	.66	03	9,10
10461003	10461003	12	10	128	.42	01	-	10461013	10461013	12	12	330	.42	03	9

Remanufactured Starters

REMANUFACTURED STARTERS

37MT (cont.)

Remanufactured Starters

Part Number	Reman Number	Volts	Pinion Teeth	Switch Pos.	Mtg. Hole	Nose Hsg.	Rem.
DELCO REMY REMANUFACTURED PART NUMBERS (CONT.)							
10461015	10461015	24	10	052	.53	01	-
10461016	10461016	24	12	308	.66	03	-
10461018	10461018	12	12	322	.66	03	11
10461044	10461044	12	10	068	.66	03	4,5
10461058	10461058	12	10	308	.66	03	2,4
10461066	10461066	12	12	308	.53	03	5
10461069	10461069	12	10	278	.53	03	6
10461084	10461084	12	10	052	.42	01	4
10461089	10461089	12	12	082	.66	03	-
10461094	10461094	12	10	308	.41	01	5
10461098	10461098	12	10	308	.41	01	8
10461108	10461108	12	10	278	.53	03	-
10461110	10461110*#12	10	308	.41	01	01	5,8
10461130	10461130	24	10	068	.66	03	5
10461169	10461169#	12	12	082	.53	03	-
10461170	10461170#	12	10	278	.53	03	7
10461207	10461207	12	10	128	.41	01	1,8
10461209	10461209*#12	10	128	.41	01	01	1,8
10461225	10461225	12	10	128	.41	01	-
10461257	10461257	24	10	322	.41	01	4
10461274	10461274*	12	12	308	.53	03	-
10461276	10461276*	12	12	082	.66	03	-
10461277	10461277	12	12	082	.53	03	5
10461295	10461295	24	10	128	.41	01	1,6,8,12
10461296	10461296	24	11	052	.41	01	5,8
10461297	10461297	24	10	038	.45	01	5,6,12
10461298	10461298	12	10	322	.41	01	1,6,8
10461299	10461299	12	11	052	.41	01	6,8,12
10461300	10461300	12	10	038	.66	03	6,12
10461301	10461301	12	12	052	.41	01	6,9,12
10461302	10461302	12	10	052	.41	01	-
10461303	10461303	12	10	052	.41	03	-
10461316	10461316	12	12	315	.66	03	5
10461330	10461330*	12	12	315	.66	03	-
10461404	10461404*	12	10	308	.66	03	2
10461405	10461405	24	12	308	.41	01	5,8,12
10461416	10461416	12	10	308	.41	01	12
10461456	10461456	12	12	308	.41	01	-
10461457	10461457	24	10	308	.41	01	12
10461494	10461494	12	10	278	.53	03	7
10461500	10461500	24	12	082	.53	03	12
10461507	10461507	12	12	330	.66	03	9
10461525	10461525	24	10	322	.41	01	12

DELCO REMY O.E. PART NUMBERS

1113089	10461089	12	12	082	.66	03	-
1990308	10461044	12	10	068	.66	03	4,5
1990309	10461003	12	10	128	.41	01	-
1990311	10461069	12	10	278	.53	03	6
1990312	10461069	12	10	278	.53	03	6
1990315	10461003	12	10	128	.42	01	-
1990317	10461089	12	12	082	.41	03	-
1990318	10461003	12	10	128	.42	01	-
1990322	10461302	12	10	052	.41	01	-
1990330	10461016	24	12	308	.66	03	-
1990332	10461016	24	12	308	.66	03	-

Part Number	Reman Number	Volts	Pinion Teeth	Switch Pos.	Mtg. Hole	Nose Hsg.	Rem.
DELCO REMY O.E. PART NUMBERS (CONT.)							
1990347	10461058	12	10	308	.66	03	2,4
1990498	10461010	12	12	030	.66	03	9,10
1990499	10461525	24	10	322	.41	01	12
1993701	10461015	24	10	052	.53	01	-
1993705	10461003	12	10	128	.42	01	-
1993707	10461016	24	12	308	.41	03	-
1993712	10461003	12	10	128	.42	01	-
1993726	10461003	12	10	128	.42	01	-
1993729	10461016	24	12	308	.66	03	-
1993732	10461016	24	12	308	.66	03	-
1993738	10461044	12	10	068	.41	03	4,5
1993741	10461015	24	10	052	.53	01	-
1993742	10461018	12	12	322	.66	03	11
1993745	10461066	12	12	308	.53	03	5
1993754	10461003	12	10	128	.42	01	-
1993755	10461013	12	12	330	.42	03	9
1993759	10461044	12	10	068	.66	03	4,5
1993761	10461069	12	10	278	.53	03	6
1993765	10461302	12	10	052	.41	01	-
1993767	10461058	12	10	308	.66	03	2,4
1993769	10461003	12	10	128	.42	01	-
1993770	10461066	12	12	308	.53	3	5
1993789	10461044	12	10	068	.66	03	4,5
1993790	10461001	12	10	038	.42	01	-
1993791	10461301	12	12	052	.41	01	6,12
1993794	10461089	12	12	082	.66	03	-
1993799	10461001	12	10	038	.42	01	-
1993818	10461069	12	10	278	.53	03	6
1993829	10461015	24	10	052	.53	01	-
1993854	10461058	12	10	308	.66	03	2,4
1993866	10461404*	12	10	308	.66	03	2
1993869	10461089	12	12	082	.66	03	-
1993871	10461089	12	12	082	.66	03	-
1993873	10461010	12	12	030	.66	03	9,10
1993874	10461089	12	12	082	.66	03	-
1993878	10461013	12	12	330	.41	03	9
1993879	10461084	12	10	052	.42	01	4
1993880	10461108	12	10	278	.53	03	-
1993881	10461303	12	10	052	.41	03	-
1993884	10461302	12	10	052	.41	01	-
1993885	10461456	12	12	308	.41	01	-
1993886	10461225	12	10	128	.41	01	-
1993887	10461066	12	12	308	.41	03	5
1993891	10461301	12	12	052	.41	01	6,12
1993893	10461300	12	10	038	.41	03	6,12
1993901	10461016	24	12	308	.66	03	-
1993902	10461018	12	12	322	.66	03	11
1993903	10461525	24	10	322	.41	01	14
1993905	10461130	24	10	068	.41	03	5
1993917	10461457	24	10	308	.41	01	14
1993920	10461500	24	12	082	.41	03	14
1993928	10461277	12	12	082	.53	03	5
1993930	10461297	24	10	038	.45	01	5,6,12
1993947	10461110*#12	10	308	.41	01	01	5,8
1993950	10461094	12	10	308	.41	01	5
1993951	10461094	12	10	308	.41	01	5
1993954	10461525	24	10	322	.41	01	12

REMANUFACTURED STARTERS



37MT (cont.)

Part Number	Reman Number	Volts	Pinion Teeth	Switch Pos.	Mtg. Hole	Nose Hsg.	Rem.
DELCO REMY O.E. PART NUMBERS (CONT.)							
1993955	10461015	24	10	052	.53	01	-
1993963	10461098	12	10	308	.41	01	8
1993964	10461098	12	10	308	.41	01	8
1993967	10461299	12	11	052	.41	01	6,8,12
1993969	10461169#	12	12	082	.53	03	-
1993972	10461296	24	11	052	.41	01	5,8
1993974	10461274*	12	12	308	.41	03	-
1993979	10461507	12	12	330	.66	03	9
1993994	10461207	12	10	128	.41	01	1,8
1993997	10461276*	12	12	082	.66	03	-
10461006	10461058	12	10	308	.41	03	2,4
10461011	10461058	12	10	308	.41	03	2,4
10461012	10461066	12	12	308	.41	03	5
10461098	10461094	12	10	308	.41	01	5
10461192	10461276*	12	12	082	.66	03	-
10461199	10461069	12	10	278	.53	03	6
10461201	10461130	24	10	068	.66	03	5
10461231	10461170#	12	10	278	.53	03	7
10461273	10461225	12	10	128	.41	01	-
10461279	10461089	12	12	082	.66	03	-
10461284	10461295	24	10	128	.41	01	1,6,8,12
10461385	10461169#	12	12	082	.53	03	-
10461387	10461276*	12	12	082	.41	03	-
10478806	10461094	12	10	308	.41	01	5
10478811	10461405	24	12	308	.41	01	5,8,12
10478831	10461225	12	10	128	.41	01	-
10478890	10461170#	12	10	278	.53	03	7
10478921	10461494	12	10	278	.53	03	7
10478976	10461295	24	10	128	.41	01	1,6,8,12
10479015	10461416	12	10	308	.41	01	14
10479020	10461295	24	10	128	.41	01	1,6,8,12
10479068	10461207	12	10	128	.41	01	1,8
10479069	10461209*#12	10	12	128	.41	01	1,8
10479108	10461257	24	10	322	.41	01	4
10479176	10461316	12	12	315	.66	03	5
10479187	10461330*	12	12	315	.66	03	-
10479195	10461298	12	10	322	.41	01	1,6,8
10479214	10461170#	12	10	278	.53	03	7

AC DELCO CATALOG NUMBERS

323-818	10461044	12	10	068	.41	03	4,5
323-829	10461010	12	12	030	.66	03	9,10
323-834	10461069	12	10	278	.53	03	6
323-835	10461001	12	10	038	.42	01	-
323-836	10461303	12	10	052	.41	03	-
323-837	10461003	12	10	128	.42	01	-
323-840	10461058	12	10	308	.66	03	2,4
323-842	10461089	12	12	082	.66	03	-
323-843	10461066	12	12	308	.53	03	5
323-844	10461010	12	12	030	.66	03	9,10
323-845	10461058	12	10	308	.66	03	2,4
323-847	10461013	12	12	330	.42	03	9
323-849	10461015	24	10	052	.53	01	-
323-850	10461016	24	12	308	.66	03	-
323-852	10461018	12	12	322	.66	03	11
323-879	10461094	12	10	308	.41	01	5
323-880	10461110*#12	10	10	308	.41	01	5,8

Part Number	Reman Number	Volts	Pinion Teeth	Switch Pos.	Mtg. Hole	Nose Hsg.	Rem.
AC DELCO CATALOG NUMBERS (CONT.)							
323-884	10461108	12	10	278	.41	03	-
323-885	10461225	12	10	128	.41	01	-
323-886	10461084	12	10	052	.42	01	4
323-886	10461084	12	10	052	.42	01	4
323-887	10461207	12	10	128	.41	01	1,8
323-888	10461209*#12	10	12	128	.41	01	1,8
323-900	10461169#	12	12	082	.41	03	-
323-901	10461170#	12	10	278	.53	03	78
323-907	10461274*	12	12	308	.53	03	-
323-908	10461277	12	12	082	.53	03	5
323-910	10461089	12	12	082	.66	03	-
323-912	10461295	24	10	128	.41	01	1,6,8,12
323-913	10461296	24	11	052	.41	01	5,8
323-914	10461297	24	10	038	.45	01	5,6,12
323-915	10461298	12	10	322	.41	01	1,6,8
323-917	10461299	12	11	052	.41	01	6,8,12
323-918	10461300	12	10	038	.41	03	6,12
323-919	10461301	12	12	052	.41	01	6,12
323-920	10461302	12	10	052	.41	01	-
323-950	10461416	12	10	308	.41	01	12
323-958	10461405	24	12	308	.41	01	5,8,12
323-959	10461404*	12	10	308	.66	03	2
323-987	10461525	24	10	322	.41	01	12

CUMMINS RECON PART NUMBERS

3604323RX	10461010	12	12	030	.66	03	9,10
3604483RX	10461089	12	12	082	.66	03	-
3604671RX	10461044	12	10	068	.66	03	4,5
3604672RX	10461069	12	10	278	.53	03	6
3604672RX	10461108	12	10	278	.53	03	-
3604673RX	10461058	12	10	308	.66	03	2,4
3675115RX	10461303	12	10	052	.41	03	-
3675115RX	10461084	12	10	052	.41	01	4
3675116RX	10461257	24	10	322	.41	01	4
3675117RX	10461500	24	12	082	.53	03	12
3675121RX	10461089	12	12	082	.41	03	-
3675164RX	10461225	12	10	128	.41	01	-
3675172RX	10461170#	12	10	278	.41	03	7

DDC CATALOG NUMBERS

R0461197	10461225	12	10	128	.41	01	-
R0461199	10461069	12	10	278	.41	03	6
R0461200	10461010	12	12	030	.66	03	9,10
R0461201	10461130	24	10	068	.66	03	5
R0461385	10461169#	12	12	082	.53	03	-
R0461387	10461276*	12	12	082	.66	03	-

DDC PART NUMBERS

10461197	10461225	12	10	128	.41	01	-
10461199	10461069	12	10	278	.53	03	6
10461200	10461010	12	12	030	.66	03	9,10
10461201	10461130	24	10	068	.66	03	5
10461385	10461169#	12	12	082	.53	03	-
10461387	10461276*	12	12	082	.66	03	-

DIXIE PART NUMBERS

TS-1504	10461010	12	12	030	.66	03	9,10
TS-1534	10461303	12	10	052	.41	03	-

Remanufactured Starters

37MT (cont.)

Part Number	Reman Number	Volts	Pinion Teeth	Switch Pos.	Mtg. Hole	Nose Hsg.	Rem.
DIXIE PART NUMBERS (CONT.)							
TS-1534	10461084	12	10	052	.42	01	4
TS-1534	10461225	12	10	128	.41	01	-
TS-1536	10461301	12	12	052	.41	01	6,12
TS-1538	10461302	12	10	052	.41	01	-
TS-1539	10461066	12	12	308	.41	03	5
TS-1539	10461089	12	12	082	.66	03	-
TS-1539	10461277	12	12	082	.53	03	5
TS-1541	10461089	12	12	082	.66	03	-
TS-1545	10461016	24	12	308	.41	03	-
TS-1547	10461069	12	10	278	.41	03	6
TS-1547	10461108	12	10	278	.53	03	-
TS-1548	10461015	24	10	052	.53	01	-
TS-1551	10461044	12	10	068	.66	03	4,5
TS-1551	10461058	12	10	308	.66	03	2,4
TS-1560	10461130	24	10	068	.41	03	5
TS-1561	10461058	12	10	308	.41	03	2,4
TS-1563	10461001	12	10	038	.42	01	-
TS-1566	10461456	12	12	308	.41	01	-
TS-1567	10461010	12	12	030	.66	03	9,10
TS-1568	10461013	12	12	330	.42	03	9
TS-1606	10461169#	12	12	082	.41	03	-
TS-1607	10461094	12	10	308	.41	01	5
TS-1608	10461110*#	12	10	308	.41	01	5,8
TS-1609	10461094	12	10	308	.41	01	5
TS-1610	10461276*	12	12	082	.66	03	-
TS-1634	10461299	12	11	052	.41	01	6,8,12
TS-1635	10461170#	12	10	278	.41	03	7

MIDLAND PART NUMBERS

RS137000X	10461089	12	12	082	.66	03	-
RS137001X	10461058	12	10	308	.66	03	2,4
RS137003X	10461069	12	10	278	.53	03	6
RS137005X	10461404*	12	10	308	.66	03	2
RS137010X	10461066	12	12	308	.53	03	5
RS137011X	10461084	12	10	052	.42	01	4
RS137012X	10461098	12	10	308	.41	01	8
RS137013X	10461110*#	12	10	308	.41	01	5,8
RS137014X	10461169#	12	12	082	.53	03	-
RS137015X	10461170#	12	10	278	.53	03	7
RS137002X	10461069	12	10	278	.53	03	6

Part Number	Reman Number	Volts	Pinion Teeth	Switch Pos.	Mtg. Hole	Nose Hsg.	Rem.
MIDLAND PART NUMBERS (CONT.)							
RS137016X	10461108	12	10	278	.53	03	-
RS137017X	10461207	12	10	128	.41	01	1,8
RS137018X	10461209*#	12	10	128	.41	01	1,8
RS137019X	10461130	24	10	068	.41	03	5

WILSON PART NUMBERS

91-01-4140	10461069	12	10	278	.53	03	6
91-01-4140	10461108	12	10	278	.53	03	-
91-01-4146	10461015	24	10	052	.53	01	-
91-01-4148	10461225	12	10	128	.41	01	-
91-01-4161	10461010	12	12	030	.66	03	9,10
91-01-4163	10461010	12	12	030	.41	03	9,10
91-01-4165	10461044	12	10	068	.66	03	4,5
91-01-4165	10461058	12	10	308	.66	03	2,4
91-01-4167	10461089	12	12	082	.66	03	-
91-01-4167	10461277	12	12	082	.53	03	5
91-01-4168	10461044	12	10	068	.66	03	4,5
91-01-4169	10461058	12	10	308	.66	03	2,4
91-01-4278	10461010	12	12	030	.66	03	9,10
91-01-4285	10461089	12	12	082	.66	03	-
91-01-4287	10461058	12	10	308	.66	03	2,4
91-01-4291	10461013	12	12	330	.42	03	9
91-01-4303	10461302	12	10	052	.41	01	-
91-01-4304	10461301	12	12	052	.41	01	6,12
91-01-4306	10461066	12	12	308	.41	03	5
91-01-4307	10461094	12	10	308	.41	01	5
91-01-4332	10461001	12	10	038	.42	01	-
91-01-4333	10461303	12	10	052	.41	03	-
91-01-4335	10461299	12	11	052	.41	01	6,8,12
91-01-4337	10461456	12	12	308	.41	01	-
91-01-4339	10461089	12	12	082	.66	03	-
91-01-4341	10461300	12	10	038	.66	03	6,12
91-01-4353	10461257	24	10	322	.41	01	4
91-01-4396	10461169#	12	12	082	.53	03	-
91-01-4399	10461500	24	12	082	.53	03	12
91-01-4409	10461110*#	12	10	308	.41	01	5,8
91-01-4412	10461276*	12	12	082	.66	03	-
91-01-4413	10461094	12	10	308	.41	01	5
91-01-4429	10461016	24	12	308	.66	03	-
91-01-4439	10461094	12	10	308	.41	01	5

38MT



Note:
† IMS - integral magnetic switch

Part Number	Reman Number	Volts	Pinion Teeth	Switch Pos.	Mtg. Hole	SAE Nose Housing
DELCO REMY REMANUFACTURED PART NUMBERS						
8300005	8300005†	12	12	082	.53	03
8300021	8300021	12	10	128	.43	01

Part Number	Reman Number	Volts	Pinion Teeth	Switch Pos.	Mtg. Hole	SAE Nose Housing
DELCO REMY REMANUFACTURED PART NUMBERS (CONT.)						
8300022	8300022†	12	11	315	.43	01
8300023	8300023†	24	10	315	.43	01

REMANUFACTURED STARTERS



38MT (cont.)

Part Number	Reman Number	Volts	Pinion Teeth	Switch Pos.	Mtg. Hole	SAE Nose Housing	Part Number	Reman Number	Volts	Pinion Teeth	Switch Pos.	Mtg. Hole	SAE Nose Housing
DELCO REMY REMANUFACTURED PART NUMBERS (CONT.)							DELCO REMY O.E. PART NUMBERS						
8300024	8300024†	12	10	315	.43	01	8200025	8300005†	12	12	82.5	.53	03
8300025	8300025†	24	12	082	.53	03	8200072	8300025†	24	12	082	.53	03
8300026	8300026†	12	11	315	.43	01	8200076	8300021	12	10	128	.43	01
10461768	10461768	12	10	127	.43	01	19026026	8300025†	24	12	082	.53	03
10461769	10461769	12	12	082	.53	03	19026027	10461768	12	10	127	.43	01
DELCO REMY O.E. PART NUMBERS							DELCO REMY O.E. PART NUMBERS						
8200000	8300025†	24	12	082	.53	03	19026028	10461769	12	12	082	.53	03
8200005	8300005	12	12	82.5	.53	03	19026029	8300005†	12	12	082	.53	03
8200007	8300022†	12	11	315	.43	01	19026030	8300025†	24	12	082	.53	03
8200023	8300024†	12	10	315	.43	01	19026031	8300024†	12	10	315	.43	01
8200024	8300023†	24	10	315	.43	01	19026032	8300023†	24	10	315	.43	01
							19026035	8300026†	12	11	315	.43	01

39MT



Note:
 * overcrank protection - OCP
 † IMS - integral magnetic switch

Part Number	Reman Number	Volts	Pinion Teeth	SW. Pos. Degrees	Mtg. Hole	SAE Nose Hsg.	Part Number	Reman Number	Volts	Pinion Teeth	SW. Pos. Degrees	Mtg. Hole	SAE Nose Hsg.
DELCO REMY REMANUFACTURED PART NUMBERS							DELCO REMY O.E. PART NUMBERS (CONT.)						
8300004	8300004†	12	12	037	.53	03	8200039	10461756	24	11	278	.66	03
8300007	8300007*†	12	12	082	.53	03	8200040	10461753	12	11	082	.66	03
8300008	8300008*†	12	12	082	.53	03	8200041	10461754	24	11	082	.66	03
8300009	8300009*†	12	11	082	.66	03	8200042	10461757	12	12	082	.53	03
8300014	8300014†	24	12	308	.53	03	8200043	10461758	24	12	308	.53	03
8300016	8300016†	24	11	278	.66	03	8200044	10461759	24	12	082	.53	03
8300018	8300018†	24	11	082	.66	03	8200045	10461760	12	12	308	.53	03
8300019	8300019†	12	11	082	.66	03	19011500	10461334	12	11	052	.66	03
10461334	10461334	12	11	052	.66	03	19011505	10461334	12	11	052	.66	03
10461753	10461753	12	11	082	.66	03	19011506	10461753	12	11	082	.66	03
10461754	10461754	24	11	082	.66	03	19011507	10461754	24	11	082	.66	03
10461755	10461755	12	11	278	.66	03	19011508	10461755	12	11	278	.66	03
10461756	10461756	24	11	278	.66	03	19011509	10461756	24	11	278	.66	03
10461757	10461757	12	12	082	.53	03	19011510	10461757	12	12	082	.53	03
10461758	10461758	24	12	308	.53	03	19011511	10461758	24	12	308	.53	03
10461759	10461759	24	12	082	.53	03	19011512	10461759	24	12	082	.53	03
10461760	10461760	12	12	308	.53	03	19011513	10461760	12	12	308	.53	03
10461773	10461773	12	12	082	.66	03	19011514	10461773	12	12	082	.66	03
10461777	10461777†	12	11	082	.66	03	19011515	8300004†	12	12	037	.53	03
DELCO REMY O.E. PART NUMBERS							DELCO REMY O.E. PART NUMBERS (CONT.)						
8200027	10461759	24	12	082	.53	03	19011516	10461777†	12	11	082	.66	03
8200028	10461760	12	12	307	.53	03	19011517	10461757	12	12	082	.53	03
8200029	10461758	12	11	052	.66	03	19011518	10461753	12	11	082	.66	03
8200030	10461757	12	12	82.5	.53	03	19011521	8300009*†	12	11	082	.66	03
8200031	10461755	12	11	278	.66	03	19011522	8300018†	24	11	082	.66	03
8200032	10461756	24	11	278	.66	03	19011523	8300016†	24	11	278	.66	03
8200033	10461753	12	11	082	.66	03	19011524	8300014†	24	12	308	.53	03
8200034	10461754	24	11	082	.66	03	19011525	8300008*†	12	12	082	.53	03
8200037	10461334	12	11	052	.66	03	19011526	8300007*†	12	12	082	.53	03
8200038	10461755	12	11	278	.66	03	19011529	8300019†	12	11	082	.66	03
							19011530	10461753	12	11	082	.66	03
							19011531	10461334	12	11	52	.66	03

Remanufactured Starters

40MT



Remarks

1. Commutator End Rotated 180°
2. Solenoid Terminals Reversed
3. 145° Nose Housing Opening
4. Nose Piece w/15° Mounting Pos. Offset by 6°

Note:

- * overcrank protection - OCP
- ** counter clockwise rotation

Remanufactured Starters

Part Number	Reman Number	Volts	Pinion Teeth	Switch Pos.	Mtg. Hole	Nose Hsg.	Rem.
DELCO REMY REMANUFACTURED PART NUMBERS							
1114786	1114786	32	11	038	.66	03	-
1990210	1990210	24	11	052	.66	03	-
1990220	1990220	12	12	308	.66	03	2
10461045	10461045	12	11	052	.66	03	-
10461046	10461046	12	12	308	.66	03	-
10461047	10461047	24	11	308	.66	03	-
10461059	10461059	12	13	322	.66	03	-
10461060	10461060	12	12	082	.53	03	1
10461071	10461071**	12	11	292	.66	03	2
10461073	10461073	12	11	068	.66	03	3
10461107	10461107	24	12	308	.66	03	-

Part Number	Reman Number	Volts	Pinion Teeth	Switch Pos.	Mtg. Hole	Nose Hsg.	Rem.
DELCO REMY O.E. PART NUMBERS							
1108857	10461047	24	11	308	.66	03	-
1108858	10461047	24	11	308	.66	03	-
1108863	10461047	24	11	308	.66	03	-
1108873	10461047	24	11	308	.66	03	-
1109854	10461047	24	11	308	.66	03	-
1109862	10461047	24	11	308	.66	03	-
1109874	10461047	24	11	308	.66	03	-
1113706	10461047	24	11	308	.66	03	-
1113707	10461047	24	11	308	.66	03	-
1113708	10461047	24	11	308	.66	03	-
1113710	10461047	24	11	308	.66	03	-
1113783	10461047	24	11	308	.66	03	-
1113814	10461047	24	11	308	.66	03	-
1113818	10461047	24	11	308	.66	03	-
1113824	10461047	24	11	308	.66	03	-
1113825	10461047	24	11	308	.66	03	-
1113831	10461047	24	11	308	.66	03	-
1113842	10461047	24	11	308	.66	03	-
1113844	1114786	32	11	038	.66	03	-
1113845	10461047	24	11	308	.66	03	-
1113846	10461047	24	11	308	.66	03	-
1113849	10461047	24	11	308	.66	03	-
1113850	10461047	24	11	308	.66	03	-
1113851	10461047	24	11	308	.66	03	-
1113855	10461047	24	11	308	.66	03	-
1113856	1990210	24	11	052	.66	03	-
1113857	1990210	24	11	052	.66	03	-
1113858	10461047	24	11	308	.66	03	-
1113861	10461047	24	11	308	.66	03	-
1113862	10461047	24	11	308	.66	03	-
1113865	1114786	32	11	038	.66	03	-

Part Number	Reman Number	Volts	Pinion Teeth	Switch Pos.	Mtg. Hole	Nose Hsg.	Rem.
DELCO REMY O.E. PART NUMBERS (CONT.)							
1113866	10461047	24	11	308	.66	03	-
1113869	1114786	32	11	038	.66	03	-
1113872	10461047	24	11	308	.66	03	-
1113874	1990210	24	11	052	.66	03	-
1113875	1990210	24	11	052	.66	03	-
1113876	10461047	24	11	308	.66	03	-
1113877	1114786	32	11	038	.66	03	-
1113878	1114786	32	11	038	.66	03	-
1113883	10461047	24	11	308	.66	03	-
1113884	1114786	32	11	038	.66	03	-
1113887	10461047	24	11	308	.66	03	-
1113895	10461047	24	11	308	.66	03	-
1113898	10461047	24	11	308	.66	03	-
1113899	1114786	32	11	038	.66	03	-
1113900	10461047	24	11	308	.66	03	-
1113905	10461047	24	11	308	.66	03	-
1113907	1990210	24	11	052	.66	03	-
1113908	1114786	32	11	038	.66	03	-
1113909	1114786	32	11	038	.66	03	-
1113911	1114786	32	11	038	.66	03	-
1113914	10461047	24	11	308	.66	03	-
1113915	10461047	24	11	308	.66	03	-
1113916	10461047	24	11	308	.66	03	-
1113920	10461047	24	11	308	.66	03	-
1113924	10461047	24	11	308	.66	03	-
1113926	10461047	24	11	308	.66	03	-
1113931	10461045	12	11	052	.66	03	-
1113935	10461047	24	11	308	.66	03	-
1113952	10461047	24	11	308	.66	03	-
1113954	1114786	32	11	038	.66	03	-
1113955	10461047	24	11	308	.66	03	-
1113957	10461047	24	11	308	.66	03	-
1113965	10461047	24	11	308	.66	03	-
1113966	10461047	24	11	308	.66	03	-
1113968	10461047	24	11	308	.66	03	-
1113972	10461047	24	11	308	.66	03	-
1113973	10461047	24	11	308	.66	03	-
1113975	10461047	24	11	308	.66	03	-
1113976	10461047	24	11	308	.66	03	-
1113977	10461047	24	11	308	.66	03	-
1113979	1114786	32	11	038	.66	03	-
1113980	10461047	24	11	308	.66	03	-
1113983	10461047	24	11	308	.66	03	-
1113991	10461047	24	11	308	.66	03	-

REMANUFACTURED STARTERS



40MT (cont.)

Part Number	Reman Number	Volts	Pinion Teeth	Switch Pos.	Mtg. Hole	Nose Hsg.	Rem.	Part Number	Reman Number	Volts	Pinion Teeth	Switch Pos.	Mtg. Hole	Nose Hsg.	Rem.
DELCO REMY O.E. PART NUMBERS (CONT.)															
1113993	10461107	24	12	308	.66	03	-	1114140	10461045	12	11	052	.66	03	-
1113997	10461047	24	11	308	.66	03	-	1114141	10461046	12	12	308	.66	03	-
1113999	10461047	24	11	308	.66	03	-	1114143	10461045	12	11	052	.66	03	-
1114046	10461073	12	11	068	.66	03	3	1114144	10461046	12	12	308	.66	03	-
1114052	10461059	12	13	322	.66	03	-	1114145	10461045	12	11	052	.66	03	-
1114055	10461045	12	11	052	.66	03	-	1114146	10461059	12	13	322	.66	03	-
1114056	10461045	12	11	052	.66	03	-	1114147	10461073	12	11	068	.66	03	3
1114058	10461045	12	11	052	.66	03	-	1114148	10461045	12	11	052	.66	03	-
1114064	10461045	12	11	052	.66	03	-	1114149	10461046	12	12	308	.66	03	-
1114070	10461073	12	11	068	.66	03	3	1114150	10461045	12	11	052	.66	03	-
1114071	10461073	12	11	068	.66	03	3	1114151	10461046	12	12	308	.66	03	-
1114072	10461045	12	11	052	.66	03	-	1114152	1990220	12	12	308	.66	03	2
1114074	10461045	12	11	052	.66	03	-	1114153	10461046	12	12	308	.66	03	-
1114076	10461045	12	11	052	.66	03	-	1114154	10461059	12	13	322	.66	03	-
1114077	10461059	12	13	322	.66	03	-	1114156	10461046	12	12	308	.66	03	-
1114078	10461045	12	11	052	.66	03	-	1114157	10461045	12	11	052	.66	03	-
1114081	10461045	12	11	052	.66	03	-	1114158	10461046	12	12	308	.66	03	-
1114084	10461045	12	11	052	.66	03	-	1114161	10461073	12	11	068	.66	03	3
1114085	10461073	12	11	068	.66	03	3	1114162	10461046	12	12	308	.66	03	-
1114086	10461045	12	11	052	.66	03	-	1114163	10461073	12	11	068	.66	03	3
1114087	10461045	12	11	052	.66	03	-	1114164	10461045	12	11	052	.66	03	-
1114088	10461045	12	11	052	.66	03	-	1114165	10461045	12	11	052	.66	03	-
1114090	10461045	12	11	052	.66	03	-	1114166	1990220	12	12	308	.66	03	2
1114092	10461045	12	11	052	.66	03	-	1114167	10461046	12	12	308	.66	03	-
1114095	10461045	12	11	052	.66	03	-	1114168	10461059	12	13	322	.66	03	-
1114096	10461045	12	11	052	.66	03	-	1114169	10461046	12	12	308	.66	03	-
1114098	10461045	12	11	052	.66	03	-	1114170	10461045	12	11	052	.66	03	-
1114100	10461071**	12	11	292	.66	03	2	1114171	1990220	12	12	308	.66	03	2
1114101	10461059	12	13	322	.66	03	-	1114172	10461045	12	11	052	.66	03	-
1114102	10461045	12	11	052	.66	03	-	1114175	10461046	12	12	308	.66	03	-
1114105	10461073	12	11	068	.66	03	3	1114176	10461073	12	11	068	.66	03	3
1114107	10461045	12	11	052	.66	03	-	1114178	10461073	12	11	068	.66	03	3
1114109	10461046	12	12	308	.66	03	-	1114180	10461045	12	11	052	.66	03	-
1114110	10461046	12	12	308	.66	03	-	1114187	10461045	12	11	052	.66	03	-
1114111	10461045	12	11	052	.66	03	-	1114188	10461045	12	11	052	.66	03	-
1114112	1990220	12	12	308	.66	03	2	1114189	10461045	12	11	052	.66	03	-
1114113	10461045	12	11	052	.66	03	-	1114190	10461046	12	12	308	.66	03	-
1114114	10461046	12	12	308	.66	03	-	1114191	1990220	12	12	308	.66	03	2
1114115	10461045	12	11	052	.66	03	-	1114192	1990220	12	12	308	.66	03	2
1114117	10461046	12	12	308	.66	03	-	1114193	10461045	12	11	052	.66	03	-
1114119	10461045	12	11	052	.66	03	-	1114194	10461045	12	11	052	.66	03	-
1114120	1990220	12	12	308	.66	03	2	1114197	10461045	12	11	052	.66	03	-
1114121	1990220	12	12	308	.66	03	2	1114198	1990220	12	12	308	.66	03	2
1114122	10461045	12	11	052	.66	03	-	1114199	10461046	12	12	308	.66	03	-
1114124	10461045	12	11	052	.66	03	-	1114705	10461046	12	12	308	.66	03	-
1114126	10461045	12	11	052	.66	03	-	1114708	10461046	12	12	308	.66	03	-
1114127	10461046	12	12	308	.66	03	-	1114709	1990220	12	12	308	.66	03	2
1114128	10461045	12	11	052	.66	03	-	1114710	10461047	24	11	308	.66	03	-
1114129	10461046	12	12	308	.66	03	-	1114714	10461046	12	12	308	.66	03	-
1114130	10461045	12	11	052	.66	03	-	1114719	1114786	32	11	038	.66	03	-
1114133	10461045	12	11	052	.66	03	-	1114715	10461047	24	11	308	.66	03	-
1114135	10461073	12	11	068	.66	03	3	1114720	10461045	12	11	052	.66	03	-
1114136	10461046	12	12	308	.66	03	-	1114722	10461045	12	11	052	.66	03	-
1114137	10461073	12	11	068	.66	03	3	1114723	10461045	12	11	052	.66	03	-
1114138	10461046	12	12	308	.66	03	-	1114724	10461046	12	12	308	.66	03	-
1114139	10461046	12	12	308	.66	03	-	1114725	10461045	12	11	052	.66	03	-

Remanufactured Starters

REMANUFACTURED STARTERS

40MT (cont.)

Part Number	Reman Number	Volts	Pinion Teeth	Switch Pos.	Mtg. Hole	Nose Hsg.	Rem.
DELCO REMY O.E. PART NUMBERS (CONT.)							
1114726	10461045	12	11	052	.66	03	-
1114727	10461047	24	11	308	.66	03	-
1114728	10461047	24	11	308	.66	03	-
1114733	1990220	12	12	308	.66	03	2
1114734	10461060	12	12	082	.53	03	1
1114736	10461071**	12	11	292	.66	03	2
1114737	10461047	24	11	308	.66	03	-
1114738	10461047	24	11	308	.66	03	-
1114739	1990210	24	11	052	.66	03	-
1114741	10461045	12	11	052	.66	03	-
1114744	1990220	12	12	308	.66	03	2
1114745	10461060	12	12	082	.53	03	1
1114746	1990220	12	12	308	.66	03	2
1114747	10461045	12	11	052	.66	03	-
1114748	10461046	12	12	308	.66	03	-
1114749	10461045	12	11	052	.66	03	-
1114750	10461045	12	11	052	.66	03	-
1114751	10461045	12	11	052	.66	03	-
1114752	10461045	12	11	052	.66	03	-
1114753	10461046	12	12	308	.66	03	-
1114754	10461046	12	12	308	.66	03	-
1114755	10461047	24	11	308	.66	03	-
1114756	10461047	24	11	308	.66	03	-
1114757	10461073	12	11	068	.66	03	3
1114758	10461073	12	11	068	.66	03	3
1114761	10461045	12	11	052	.66	03	-
1114763	1114786	32	11	038	.66	03	-
1114769	10461045	12	11	052	.66	03	-
1114770	10461059	12	13	322	.66	03	-
1114771	10461059	12	13	322	.66	03	-
1114775	10461059	12	13	322	.66	03	-
1114776	10461107	24	12	308	.66	03	-
1114778	10461071**	12	11	292	.66	03	2
1114787	10461060	12	12	082	.53	03	1
1114789	10461059	12	13	322	.66	03	-
1114790	10461047	24	11	308	.66	03	-
1114791	10461045	12	11	052	.66	03	-
1114796	10461059	12	13	322	.66	03	-
1114799	10461045	12	11	052	.66	03	-
1114810	10461073	12	11	068	.66	03	3
1114812	10461045	12	11	052	.66	03	-
1114813	10461045	12	11	052	.66	03	-
1114814	10461045	12	11	052	.66	03	-
1114815	10461045	12	11	052	.66	03	-
1114816	10461045	12	11	052	.66	03	-
1114817	10461073	12	11	068	.66	03	3
1114818	10461073	12	11	068	.66	03	3
1114819	10461045	12	11	052	.66	03	-
1114820	10461045	12	11	052	.66	03	-
1114823	10461046	12	12	308	.66	03	-
1114824	10461046	12	12	308	.66	03	-
1114825	10461046	12	12	308	.66	03	-
1114826	1990220	12	12	308	.66	03	2
1114827	10461046	12	12	308	.66	03	-
1114828	10461046	12	12	308	.66	03	-
1114829	1990220	12	12	308	.66	03	2

Part Number	Reman Number	Volts	Pinion Teeth	Switch Pos.	Mtg. Hole	Nose Hsg.	Rem.
DELCO REMY O.E. PART NUMBERS (CONT.)							
1114830	1990220	12	12	308	.66	03	2
1114831	10461107	24	12	308	.66	03	-
1114832	10461046	12	12	308	.66	03	-
1114833	1990220	12	12	308	.66	03	2
1114834	10461046	12	12	308	.66	03	-
1114835	10461046	12	12	308	.66	03	-
1114839	10461059	12	13	322	.66	03	-
1114840	1990210	24	11	052	.66	03	-
1114842	10461047	24	11	308	.66	03	-
1114843	10461107	24	12	308	.66	03	-
1114844	10461047	24	11	308	.66	03	-
1114846	10461047	24	11	308	.66	03	-
1114847	10461047	24	11	308	.66	03	-
1114848	10461047	24	11	308	.66	03	-
1114849	10461047	24	11	308	.66	03	-
1114850	10461047	24	11	308	.66	03	-
1114851	10461047	24	11	308	.66	03	-
1114852	10461047	24	11	308	.66	03	-
1114853	10461047	24	11	308	.66	03	-
1114854	10461047	24	11	308	.66	03	-
1114855	10461047	24	11	308	.66	03	-
1114859	10461107	24	12	308	.66	03	-
1114866	1114786	32	11	038	.66	03	-
1114868	1114786	32	11	038	.66	03	-
1114867	1114786	32	11	038	.66	03	-
1114873	10461047	24	11	308	.66	03	-
1114874	10461047	24	11	308	.66	03	-
1114875	10461047	24	11	308	.66	03	-
1114878	10461047	24	11	308	.66	03	-
1114879	10461047	24	11	308	.66	03	-
1114880	10461047	24	11	308	.66	03	-
1114881	1990220	12	12	308	.66	03	2
1114882	10461046	12	12	308	.66	03	-
1114883	10461046	12	12	308	.66	03	-
1114884	10461060	12	12	082	.53	03	1
1114885	10461046	12	12	308	.66	03	-
1114886	10461060	12	12	082	.53	03	1
1114887	1990220	12	12	308	.66	03	2
1114888	10461046	12	12	308	.66	03	-
1114889	10461045	12	11	052	.66	03	-
1114890	10461045	12	11	052	.66	03	-
1114891	10461045	12	11	052	.66	03	-
1114892	10461045	12	11	052	.66	03	-
1114893	10461045	12	11	052	.66	03	-
1114894	10461045	12	11	052	.66	03	-
1114895	10461045	12	11	052	.66	03	-
1114896	10461045	12	11	052	.66	03	-
1114897	10461045	12	11	052	.66	03	-
1114898	10461045	12	11	052	.66	03	-
1114899	10461045	12	11	052	.66	03	-
1114900	10461045	12	11	052	.66	03	-
1114901	10461045	12	11	052	.66	03	-
1114902	10461071**	12	11	292	.66	03	2
1114903	10461047	24	11	308	.66	03	-
1114904	10461059	12	13	322	.66	03	-
1114905	10461107	24	12	308	.66	03	-

Remanufactured Starters

REMANUFACTURED STARTERS



40MT (cont.)

Part Number	Reman Number	Volts	Pinion Teeth	Switch Pos.	Mtg. Hole	Nose Hsg.	Rem.
DELCO REMY O.E. PART NUMBERS (CONT.)							
1114906	10461045	12	11	052	.66	03	-
1114907	10461047	24	11	308	.66	03	-
1114909	10461047	24	11	308	.66	03	-
1114911	10461046	12	12	308	.66	03	-
1114913	10461045	12	11	052	.66	03	-
1114915	10461047	24	11	308	.66	03	-
1114918	10461048*	12	11	052	.66	03	-
1114920	10461059	12	13	322	.66	03	-
1114922	1990210	24	11	052	.66	03	-
1114923	10461047	24	11	308	.66	03	-
1114924	1114786	32	11	038	.66	03	-
1114927	10461059	12	13	322	.66	03	-
1114928	10461045	12	11	052	.66	03	-
1114932	10461073	12	11	068	.66	03	3
1114933	10461046	12	12	308	.66	03	-
1114934	10461059	12	13	322	.66	03	-
1114935	10461047	24	11	308	.66	03	-
1114936	10461059	12	13	322	.66	03	-
1114937	10461045	12	11	052	.66	03	-
1114938	10461067*	12	11	052	.66	03	-
1114939	10461067*	12	11	052	.66	03	-
1114941	10461045	12	11	052	.66	03	-
1114944	10461059	12	13	322	.66	03	-
1114946	10461045	12	11	052	.66	03	-
1114947	10461047	24	11	308	.66	03	-
1114950	10461047	24	11	308	.66	03	-
1114951	10461047	24	11	308	.66	03	-
1114952	1990210	24	11	052	.66	03	-
1114958	10461047	24	11	308	.66	03	-
1114961	10461045	12	11	052	.66	03	-
1114963	10461047	24	11	308	.66	03	-
1114964	10461047	24	11	308	.66	03	-
1114966	1990220	12	12	308	.66	03	2
1114967	10461046	12	12	308	.66	03	-
1114970	10461047	24	11	308	.66	03	-
1114977	10461060	12	12	082	.53	03	1
1114978	10461045	12	11	052	.66	03	-
1114979	10461047	24	11	308	.66	03	-
1114981	10461047	24	11	308	.66	03	-
1114983	10461045	12	11	052	.66	03	-
1114984	10461045	12	11	052	.66	03	-
1114985	10461045	12	11	052	.66	03	-
1114986	10461046	12	12	308	.66	03	-
1114987	10461047	24	11	308	.66	03	-
1114988	10461073	12	11	068	.66	03	3
1114989	10461107	24	12	308	.66	03	-
1114997	10461073	12	11	068	.66	03	3
1114998	1990210	24	11	052	.66	03	-
1990200	10461061*	12	12	308	.66	03	-
1990205	1990220	12	12	308	.66	03	2
1990208	10461061*	12	12	308	.66	03	-
1990221	10461046	12	12	308	.66	03	-
1990281	10461046	12	12	308	.66	03	-
1990282	10461047	24	11	308	.66	03	-
1990283	10461107	24	12	308	.66	03	-
1990306	10461045	12	11	052	.66	03	-
1990323	10461045	12	11	052	.66	03	-

Part Number	Reman Number	Volts	Pinion Teeth	Switch Pos.	Mtg. Hole	Nose Hsg.	Rem.
DELCO REMY O.E. PART NUMBERS (CONT.)							
1990325	10461046	12	12	308	.66	03	-
1990340	1990210	24	11	052	.66	03	-
1990462	10461047	24	11	308	.66	03	-
1993703	10461046	12	12	308	.66	03	-
AC DELCO CATALOG NUMBERS							
323-611	10461059	12	13	322	.66	03	-
323-614	10461071**	12	11	292	.66	03	2
323-622	1114786	32	11	038	.66	03	-
323-623	10461060	12	12	082	.53	03	1
323-773	10461045	12	11	052	.66	03	-
323-774	10461046	12	12	308	.66	03	-
323-775	10461047	24	11	308	.66	03	-
323-776	10461073	12	11	068	.66	03	3
323-777	10461107	24	12	308	.66	03	-
323-781	10461047	24	11	308	.66	03	-
323-782	1990210	24	11	052	.66	03	-
323-791	1990220	12	12	308	.66	03	2
BERMAN PART NUMBERS							
DS-07	10461047	24	11	308	.66	03	-
DS-08	10461060	12	12	082	.53	03	1
DS-10	10461045	12	11	052	.66	03	-
DS-11	10461046	12	12	308	.66	03	-
CARGO PART NUMBERS							
110301	10461047	24	11	308	.66	03	-
110302	10461047	24	11	308	.66	03	-
110436	10461046	12	12	308	.66	03	-
111039	10461045	12	11	052	.66	03	-
CUMMINS RECON PART NUMBERS							
3603862RX	10461047	24	11	308	.66	03	-
3603863RX	10461045	12	11	052	.66	03	-
3603864RX	10461046	12	12	308	.66	03	-
3603865RX	10461059	12	13	322	.66	03	-
3604232RX	10461073	12	11	068	.66	03	3
3604233RX	10461107	24	12	308	.66	03	-
3604492RX	10461046	12	12	308	.66	03	-
3604493RX	10461046	12	12	308	.66	03	-
DDC CATALOG NUMBERS							
R0461178	10461045	12	11	052	.66	03	-
R0461179	10461047	24	11	308	.66	03	-
DDC PART NUMBERS							
10461178	10461045	12	11	052	.66	03	-
10461179	10461047	24	11	308	.66	03	-
DIXIE PART NUMBERS							
S-1083	10461047	24	11	308	.66	03	-
S-1104	10461059	12	13	322	.66	03	-
S-1107	10461045	12	11	052	.66	03	-
S-1108	10461073	12	11	068	.66	03	3
S-1132	10461046	12	12	308	.66	03	-
S-1139	10461107	24	12	308	.66	03	-
S-1192	10461061*	12	12	308	.66	03	-
TS-1160	1990210	24	11	052	.66	03	-

Remanufactured Starters

REMANUFACTURED STARTERS

40MT (cont.)

Part Number	Reman Number	Volts	Pinion Teeth	Switch Pos.	Mtg. Hole	Nose Hsg.	Rem.
DIXIE PART NUMBERS (CONT.)							
TS-1177	10461060	12	12	082	.53	03	1
TS-1191	10461071**	12	11	292	.66	03	2
TS-1327	1114786	32	11	038	.66	03	-
MIDLAND PART NUMBERS							
RS140000X	10461047	24	11	308	.66	03	-
RS140001X	10461045	12	11	052	.66	03	-
RS140002X	10461046	12	12	308	.66	03	-
RS140003X	10461059	12	13	322	.66	03	-
RS140005X	10461073	12	11	068	.66	03	3
RS140006X	10461107	24	12	308	.66	03	-
RS140015X	10461060	12	12	082	.53	03	1
RS140022X	10461071**	12	11	292	.66	03	2
WILSON PART NUMBERS							
91-01-3700	10461047	24	11	308	.66	03	-
91-01-3701	10461045	12	11	052	.66	03	-

Part Number	Reman Number	Volts	Pinion Teeth	Switch Pos.	Mtg. Hole	Nose Hsg.	Rem.
WILSON PART NUMBERS (CONT.)							
91-01-3702	10461046	12	12	308	.66	03	-
91-01-3703	10461107	24	12	308	.66	03	-
91-01-3772	10461045	12	11	052	.66	03	-
91-01-3774	10461045	12	11	052	.66	03	-
91-01-3787	10461059	12	13	322	.66	03	-
91-01-3791	1990220	12	12	308	.66	03	2
91-01-3793	10461045	12	11	052	.66	03	-
91-01-4024	1990210	24	11	052	.66	03	-
91-01-4040	10461046	12	12	308	.66	03	-
91-01-4050	10461046	12	12	308	.66	03	-
91-01-4083	1114786	32	11	038	.66	03	-
91-01-4104	10461045	12	11	052	.66	03	-
91-01-4131	10461047	24	11	308	.66	03	-
91-01-4137	10461047	24	11	308	.66	03	-

41MT



SAE No 1 Flange
215° Flywheel Opening



SAE No 3 Flange
180° Flywheel Opening

Remarks

1. Commutator End Rotated 180°
2. Solenoid Terminals Reversed
3. 145° Nose Housing Opening
4. Offset Nose Housing
5. Ground Stud in Frame
6. 215° Nose Housing
7. Nose Piece w/15° Mounting Pos. Offset by 7-1/2°
8. Ground Stud on CE Frame

*Note: overcrank protection - OCP

Part Number	Reman Number	Volts	Pinion Teeth	Switch Pos.	Mtg. Hole	Nose Hsg.	Rem.
DELCO REMY REMANUFACTURED PART NUMBERS							
10461171	10461171	12	12	082	.53	03	-
10461239	10461239	24	12	322	.53	03	-
10461240	10461240	12	12	322	.53	03	-
10461282	10461282	12	12	128	.41	01	5
10461304	10461304*	12	12	082	.53	03	-
10461318	10461318	12	11	082	.66	03	-
10461333	10461333	24	11	052	.66	03	-
10461408	10461408	24	11	052	.66	03	1
10461409	10461409	12	11	052	.66	03	1
10461417	10461417	24	12	308	.41	01	6,7
10461431	10461431*	12	12	128	.41	01	1,4,6
10461434	10461434	12	12	308	.41	01	6,7
10461435	10461435	12	12	082	.53	03	5
10461436	10461436	12	12	308	.41	01	5,6
10461439	10461439*	12	12	129	.41	01	6
10461458	10461458	24	12	278	.53	03	5
10461496	10461496	12	12	128	.41	01	15
10461503	10461503*	24	11	052	.66	03	-
10461504	10461504	24	11	322	.66	03	1
10461528	10461528*	24	12	082	.53	03	-

Part Number	Reman Number	Volts	Pinion Teeth	Switch Pos.	Mtg. Hole	Nose Hsg.	Rem.
DELCO REMY O.E. PART NUMBERS							
10461153	10461417	24	12	308	.41	01	6,7
10461182	10461333	24	11	052	.66	03	-
10461227	10461171	12	12	082	.53	03	-
10461319	10461318	12	11	082	.66	03	-
10461384	10461304*	12	12	082	.53	03	-
10461386	10461171	12	12	082	.53	03	-
10461390	10461408	24	11	052	.66	03	1
10461391	10461409	12	11	052	.66	03	1
10461395	10461417	24	12	308	.41	01	6,7
10478812	10461304*	12	12	082	.53	03	-
10478817	10461239	24	12	322	.53	03	-
10478818	10461240	12	12	322	.53	03	-
10478898	10461333	24	11	052	.66	03	-
10478961	10461417	24	12	308	.41	01	6,7
10478999	10461171	12	12	082	.53	03	-
10479013	10461417	24	12	308	.41	01	6,7
10479023	10461409	12	11	052	.66	03	1
10479024	10461408	24	11	052	.66	03	1
10479043	10461503*	24	11	052	.66	03	-
10479079	10461504	24	11	322	.66	03	1
10479102	10461282	12	12	128	.41	01	5

REMANUFACTURED STARTERS



41MT (cont.)

Part Number	Reman Number	Volts	Pinion Teeth	Switch Pos.	Mtg. Hole	Nose Hsg.	Rem.
DELCO REMY O.E. PART NUMBERS (CONT.)							
10479109	10461240	12	12	322	.53	03	-
10479148	10461528*	24	12	082	.53	03	-
10479165	10461318	12	11	082	.66	03	-
10479205	10461458	24	12	278	.53	03	5
10479206	10461434	12	12	308	.41	01	6,7
10479215	10461431*	12	12	128	.41	01	1,4,6
10479226	10461282	12	12	128	.41	01	5
10479232	10461528*	24	12	082	.53	03	-
10479242	10461496	12	12	128	.41	01	8
10479243	10461439*	12	12	129	.41	01	6
10479246	10461436	12	12	308	.41	01	5,6
10479249	10461496	12	12	128	.41	01	8
10479250	10461435	12	12	082	.53	03	5

AC DELCO CATALOG NUMBERS

323-897	10461171	12	12	082	.41	03	-
323-921	10461318	12	11	082	.66	03	-
323-946	10461408	24	11	052	.66	03	1
323-947	10461409	12	11	052	.66	03	1
323-951	10461417	24	12	308	.41	01	6,7

Part Number	Reman Number	Volts	Pinion Teeth	Switch Pos.	Mtg. Hole	Nose Hsg.	Rem.
DDC CATALOG NUMBERS							
R0461386	10461171	12	12	082	.41	03	-
R0461384	10461304*	12	12	082	.53	03	-
R0461182	10461333	24	11	052	.41	03	-

DDC PART NUMBERS

10461386	10461171	12	12	082	.41	03	-
10461384	10461304*	12	12	082	.53	03	-
10461182	10461333	24	11	052	.41	03	-

DIXIE PART NUMBERS

TS-1650	10461409	12	11	052	.66	03	1
TS-1651	10461240	12	12	322	.53	03	-
TS-1652	10461171	12	12	082	.41	03	-
TS-1653	10461333	24	11	052	.66	03	-
TS-1681	10461282	12	12	128	.41	01	5
TS-1682	10461431*	12	12	128	.41	01	1,4,6

WILSON NUMBERS

91-01-4360	10461239	24	12	322	.53	03	-
91-01-4466	10461304*	12	12	082	.53	03	-
91-01-4468	10461409	12	11	052	.66	03	1
91-01-4469	10461333	24	11	052	.66	03	-

42MT



SAE No 1 Flange
215° Flywheel Opening

SAE No 3 Flange
180° Flywheel Opening

SAE No 3 Flange
145° Flywheel Opening

Remarks

- Commutator End Rotated 180°
- Solenoid Terminals Reversed
- 145 Nose Housing Opening
- Offset Nose Housing
- 215° Nose Housing
- Nose Piece w/15° Mounting Pos. Offset by 7-1/2°
- Special Lever Housing
- Provisions for Mounting Shield

Note:

- * overcrank protection - OCP
- ** counter clockwise rotation
- † IMS - integral magnetic switch

Part Number	Reman Number	Volts	Pinion Teeth	Switch Pos.	Mtg. Hole	Nose Hsg.	Rem.
DELCO REMY REMANUFACTURED PART NUMBERS							
10461020	10461020	12	11	068	.66	03	-
10461021	10461021	12	12	082	.66	03	-
10461025	10461025	24	12	308	.66	03	-
10461050	10461050	12	12	082	.66	03	1
10461051	10461051	12	12	292	.66	03	2
10461052	10461052	12	11	082	.66	03	-
10461053	10461053	12	11	088	.66	03	7
10461054	10461054	24	11	088	.66	03	-
10461055	10461055*	12	11	082	.66	03	-
10461068	10461068	24	11	038	.66	03	-
10461075	10461075*	12	11	088	.66	03	-
10461077	10461077	12	12	082	.66	03	3
10461078	10461078*	12	12	082	.66	03	3
10461079	10461079*	12	12	278	.66	03	2
10461091	10461091	12	12	082	.66	03	-

Part Number	Reman Number	Volts	Pinion Teeth	Switch Pos.	Mtg. Hole	Nose Hsg.	Rem.
DELCO REMY REMANUFACTURED PART NUMBERS							
10461096	10461096*	12	11	052	.66	03	-
10461131	10461131	12	11	292	.66	03	2,3
10461132	10461132**	12	11	038	.66	03	-
10461133	10461133	12	13	322	.66	03	-
10461134	10461134	24	11	052	.66	03	-
10461135	10461135	24	11	292	.66	03	2
10461136	10461136	24	12	308	.53	03	-
10461137	10461137	24	13	322	.66	03	-
10461138	10461138*	12	11	292	.66	03	3
10461139	10461139*	24	11	292	.66	03	2,3
10461140	10461140*	24	11	038	.66	03	2
10461141	10461141*	24	11	052	.66	03	-
10461151	10461151†	12	12	082	.66	03	3
10461162	10461162†	12	12	052	.53	03	-
10461163	10461163*†	12	12	052	.53	03	-

42MT (cont.)

Part Number	Reman Number	Volts	Pinion Teeth	Switch Pos.	Mtg. Hole	Nose Hsg.	Rem.
DELCO REMY REMANUFACTURED PART NUMBERS (CONT.)							
10461164	10461164†	12	11	082	.66	03	-
10461165	10461165†	12	11	082	.66	03	-
10461166	10461166	12	12	270	.66	03	-
10461172	10461172*†	12	12	082	.66	03	3
10461233	10461233*	12	12	082	.53	03	-
10461265	10461265†	12	12	052	.53	03	-
10461266	10461266*†	12	12	052	.53	03	-
10461267	10461267†	12	11	082	.66	03	-
10461268	10461268†	12	11	082	.66	03	-
10461269	10461269†	12	12	082	.66	03	3
10461270	10461270*†	12	12	082	.66	03	3
10461271	10461271†	12	11	088	.66	03	-
10461272	10461272*†	12	11	088	.66	03	-
10461324	10461324*	12	12	285	.66	03	-
10461326	10461326	12	11	082	.66	03	8
10461328	10461328	12	12	038	.53	01	-
10461329	10461329*	12	12	038	.66	03	-
10461351	10461351	24	11	038	.53	03	2
10461353	10461353	24	11	038	.66	03	2
10461358	10461358	24	12	308	.66	03	-
10461360	10461360	24	11	082	.66	03	-
10461388	10461388*	12	12	128	.41	01	4,5
10461410	10461410	24	11	278	.66	03	1
10461411	10461411	12	11	088	.66	03	-
10461412	10461412	24	12	052	.53	SP	8
10461413	10461413	24	12	082	.66	03	3,8
10461414	10461414	12	12	082	.66	03	8
10461415	10461415	12	11	068	.66	03	1
10461418	10461418	24	12	082	.53	03	1,6
10461501	10461501	12	12	082	.53	03	11
10461585	10461585*	12	11	278	.66	03	11
10461591	10461591	12	11	278	.66	03	2,6
10461592	10461592	12	11	308	.66	03	-
10462155	10462155	12	11	082	.66	03	-
10462175	10462175	12	11	088	.66	03	-
10462196	10462196	12	11	052	.66	03	-

DELCO REMY O.E. PART NUMBERS

1990337	10461052	12	11	082	.66	03	-
1990344	10461068	24	11	038	.66	03	-
1990348	10461052	12	11	082	.66	03	-
1990352	10461052	12	11	082	.66	03	-
1990355	10461055*	12	11	082	.66	03	-
1990357	10461025	24	12	308	.66	03	-
1990358	10461052	12	11	082	.66	03	-
1990359	10461025	24	12	308	.66	03	-
1990360	10461025	24	12	308	.66	03	-
1990361	10461068	24	11	038	.66	03	-
1990362	10461021	12	12	082	.66	03	-
1990363	10461052	12	11	082	.66	03	-
1990364	10461136	24	12	308	.53	03	-
1990366	10461025	24	12	308	.66	03	-
1990367	10461068	24	11	038	.66	03	-
1990368	10461068	24	11	038	.66	03	-
1990369	10461051	12	12	292	.66	03	2
1990370	10461021	12	12	082	.66	03	-

Part Number	Reman Number	Volts	Pinion Teeth	Switch Pos.	Mtg. Hole	Nose Hsg.	Rem.
DELCO REMY O.E. PART NUMBERS (CONT.)							
1990372	10461077	12	12	082	.66	03	3
1990373	10461025	24	12	308	.66	03	-
1990375	10461052	12	11	082	.66	03	-
1990376	10461052	12	11	082	.66	03	-
1990377	10461132**	12	11	038	.66	03	-
1990378	10461068	24	11	038	.66	03	-
1990379	10461050	12	12	082	.66	03	1
1990380	10461131	12	11	292	.66	03	2,3
1990381	10461135	24	11	292	.66	03	2
1990382	10461068	24	11	038	.66	03	-
1990383	10461068	24	11	038	.66	03	-
1990386	10461052	12	11	082	.66	03	-
1990388	10461068	24	11	038	.66	03	-
1990391	10461055*	12	11	082	.66	03	-
1990393	10461055*	12	11	082	.66	03	-
1990394	10461021	12	12	082	.66	03	-
1990397	10461078*	12	12	082	.66	03	3
1990398	10461052	12	11	082	.66	03	-
1990400	10461052	12	11	082	.66	03	-
1990401	10461051	12	12	292	.66	03	2
1990402	10461025	24	12	308	.66	03	-
1990403	10461021	12	12	082	.66	03	-
1990404	10461050	12	12	082	.66	03	1
1990405	10461050	12	12	082	.66	03	1
1990406	10461233*	12	12	082	.66	03	-
1990407	10461051	12	12	292	.66	03	2
1990413	10461025	24	12	308	.66	03	-
1990415	10461341	24	12	278	.66	03	-
1990418	10461068	24	11	038	.66	03	-
1990419	10461051	12	12	292	.66	03	2
1990420	10461052	12	11	082	.66	03	-
1990421	10461096*	12	11	052	.66	03	-
1990422	10461068	24	11	038	.66	03	-
1990423	10461052	12	11	082	.66	03	-
1990424	10461052	12	11	082	.66	03	-
1990428	10461055*	12	11	082	.66	03	-
1990429	10461021	12	12	082	.66	03	-
1990430	10461132**	12	11	038	.66	03	-
1990431	10461020	12	11	068	.66	03	-
1990435	10461137	24	13	322	.66	03	-
1990436	10461134	24	11	052	.66	03	-
1990437	10461068	24	11	038	.66	03	-
1990438	10461132**	12	11	038	.66	03	-
1990446	10461020	12	11	068	.66	03	-
1990447	10461134	24	11	052	.66	03	-
1990450	10461052	12	11	082	.66	03	-
1990451	10461079*	12	12	278	.66	03	2
1990453	10461025	24	12	308	.66	03	-
1990455	10461025	24	12	308	.66	03	-
1990456	10461068	24	11	038	.66	03	-
1990460	10461068	24	11	038	.66	03	-
1990468	10461052	12	11	082	.66	03	-
1990470	10461052	12	11	082	.66	03	-
1990471	10461021	12	12	082	.66	03	-
1990474	10461025	24	12	308	.66	03	-
1990475	10461052	12	11	082	.66	03	-

REMANUFACTURED STARTERS



42MT (cont.)

Part Number	Reman Number	Volts	Pinion Teeth	Switch Pos.	Mtg. Hole	Nose Hsg.	Rem.	Part Number	Reman Number	Volts	Pinion Teeth	Switch Pos.	Mtg. Hole	Nose Hsg.	Rem.
DELCO REMY O.E. PART NUMBERS (CONT.)								DELCO REMY O.E. PART NUMBERS (CONT.)							
1990476	10461051	12	12	292	.66	03	2	1993941	10461360	24	11	082	.66	03	-
1990477	10461052	12	11	082	.66	03	-	1993943	10461414	12	12	082	.66	03	8
1990478	10461052	12	11	082	.66	03	-	1993944	10461358	24	12	308	.66	03	-
1990483	10461052	12	11	082	.66	03	-	1993961	10461021	12	12	082	.66	03	-
1990484	10461055*	12	11	082	.66	03	-	1993973	10461078*	12	12	082	.66	03	3
1990485	10461068	24	11	038	.66	03	-	1993982	10461326	12	11	082	.66	03	8
1990489	10461075*	12	11	088	.66	03	-	1993983	10461414	12	12	082	.66	03	8
1990490	10461053	12	11	088	.66	03	7	1993993	10461025	24	12	308	.66	03	-
1990491	10461054	24	11	088	.66	03	-	1993996	10461351	24	11	038	.53	03	2
1990492	10461050	12	12	082	.66	03	1	1993998	10461353	24	11	038	.66	03	2
1990493	10461068	24	11	038	.66	03	-	1993999	10461140*	24	11	038	.66	03	2
1990495	10461052	12	11	082	.66	03	-	10461022	10461132**	12	11	038	.66	03	-
1990496	10461414	12	12	082	.66	03	8	10461024	10461068	24	11	038	.66	03	-
1990497	10461358	24	12	308	.66	03	-	10461026	10461137	24	13	322	.66	03	-
1993776	10461055*	12	11	082	.66	03	-	10461027	10461134	24	11	052	.66	03	-
1993782	10461051	12	12	292	.66	03	2	10461028	10461055*	12	11	082	.66	03	-
1993783	10461050	12	12	082	.66	03	1	10461029	10461412	24	12	052	.53	SP	8
1993785	10461132**	12	11	038	.66	03	-	10461030	10461068	24	11	038	.66	03	-
1993788	10461141*	24	11	052	.66	03	-	10461031	10461358	24	12	308	.66	03	-
1993795	10461021	12	12	082	.66	03	-	10461032	10461414	12	12	082	.66	03	8
1993796	10461025	24	12	308	.66	03	-	10461033	10461052	12	11	082	.66	03	-
1993801	10461412	24	12	052	.53	SP	8	10461034	10461051	12	12	292	.66	03	2
1993802	10461360	24	11	082	.66	03	-	10461035	10461413	24	12	082	.66	03	3,8
1993803	10461052	12	11	082	.66	03	-	10461036	10461091	12	12	082	.66	03	-
1993804	10461358	24	12	308	.66	03	-	10461038	10461052	12	11	082	.66	03	-
1993805	10461360	24	11	082	.66	03	-	10461042	10461053	12	11	088	.66	03	7
1993806	10461414	12	12	082	.66	03	8	10461043	10461054	24	11	088	.66	03	-
1993807	10461052	12	11	082	.66	03	-	10461062	10461075*	12	11	088	.66	03	-
1993808	10461358	24	12	308	.66	03	-	10461063	10461233*	12	12	082	.66	03	-
1993810	10461360	24	11	082	.66	03	-	10461065	10461079*	12	12	278	.66	03	2
1993811	10461051	12	12	292	.66	03	2	10461068	10461068	24	11	038	.66	03	-
1993812	10461413	24	12	082	.66	03	3,8	10461076	10461077	12	12	082	.66	03	3
1993813	10461091	12	12	082	.66	03	-	10461080	10461141*	24	11	052	.66	03	-
1993814	10461358	24	12	308	.66	03	-	10461090	10461091	12	12	082	.66	03	-
1993815	10461358	24	12	308	.66	03	-	10461097	10461131	12	11	292	.66	03	2,3
1993816	10461052	12	11	082	.66	03	-	10461126	10461052	12	11	082	.66	03	-
1993820	10461021	12	12	082	.66	03	-	10461127	10461053	12	11	088	.66	03	7
1993821	10461140*	24	11	038	.66	03	2	10461133	10461132**	12	11	038	.66	03	-
1993822	10461136	24	12	308	.53	03	-	10461142	10461358	24	12	308	.66	03	-
1993824	10461079*	12	12	278	.66	03	2	10461143	10461360	24	11	082	.66	03	-
1993827	10461139*	24	11	292	.66	03	2,3	10461145	10461414	12	12	082	.66	03	8
1993833	10461136	24	12	308	.53	03	-	10461147	10461411	12	11	088	.66	03	-
1993842	10461360	24	11	082	.66	03	-	10461148	10461413	24	12	082	.66	03	3,8
1993849	10461138*	12	11	292	.66	03	3	10461183	10461055*	12	11	082	.66	03	-
1993856	10461091	12	12	082	.66	03	-	10461184	10461054	24	11	088	.66	03	-
1993857	10461132**	12	11	038	.66	03	-	10461185	10461075*	12	11	088	.66	03	-
1993863	10461166	12	12	270	.66	03	-	10461193	10461134	24	11	052	.66	03	-
1993872	10461051	12	12	292	.66	03	2	10461194	10461132**	12	11	038	.66	03	-
1993925	10461324*	12	12	285	.66	03	-	10461206	10461233*	12	12	082	.66	03	-
1993929	10461341	24	12	278	.66	03	-	10461211	10461172*†	12	12	082	.66	03	3
1993933	10461360	24	11	082	.66	03	-	10461212	10461151†	12	12	082	.66	03	3
1993935	10461414	12	12	082	.66	03	8	10461213	10461165†	12	11	082	.66	03	-
1993936	10461358	24	12	308	.66	03	-	10461214	10461164†	12	11	082	.66	03	-
1993937	10461414	12	12	082	.66	03	8	10461215	10461163*†	12	12	052	.53	03	-
1993938	10461414	12	12	082	.66	03	8	10461216	10461162†	12	12	052	.53	03	-
1993939	10461414	12	12	082	.66	03	8	10461217	10461134	24	11	052	.66	03	-

Remanufactured Starters

42MT (cont.)

Part Number	Reman Number	Volts	Pinion Teeth	Switch Pos.	Mtg. Hole	Nose Hsg.	Rem.
DELCO REMY O.E. PART NUMBERS (CONT.)							
10461228	10461078*	12	12	082	.66	03	3
10461232	10461096*	12	11	052	.66	03	-
10461323	10461324*	12	12	285	.66	03	-
10461327	10461326	12	11	082	.66	03	8
10461331	10461166	12	12	270	.66	03	-
10461332	10461079*	12	12	278	.66	03	2
10461337	10461135	24	11	292	.66	03	2
10461338	10461341	24	12	278	.66	03	-
10461339	10461341	24	12	278	.66	03	-
10461350	10461353	24	11	038	.66	03	2
10461351	10461351	24	11	038	.53	03	2
10461354	10461351	24	11	038	.53	03	2
10461355	10461140*	24	11	038	.66	03	2
10461357	10461358	24	12	308	.66	03	-
10461359	10461360	24	11	082	.66	03	-
10461365	10461410	24	11	278	.66	03	1
10461389	10461388*	12	12	128	.41	01	4,5
10461392	10461415	12	11	068	.66	03	1
10461393	10461411	12	11	088	.66	03	-
10461396	10461412	24	12	052	.53	SP	8
10461397	10461413	24	12	082	.66	03	3,8
10461398	10461414	12	12	082	.66	03	8
10478809	10461591	12	11	278	.66	03	2,6
10478810	10461592	12	11	308	.66	03	-
10478824	10461585*	12	11	278	.66	03	6
10478832	10461326	12	11	082	.66	03	8
10478835	10461414	12	12	082	.66	03	8
10478836	10461140*	24	11	038	.66	03	2
10478839	10461412	24	12	052	.53	SP	8
10478892	10461351	24	11	038	.53	03	2
10478893	10461353	24	11	038	.66	03	2
10478894	10461052	12	11	082	.66	03	-
10478895	10461052	12	11	082	.66	03	-
10478918	10461051	12	12	292	.66	03	2
10478931	10461414	12	12	082	.66	03	8
10478932	10461411	12	11	088	.66	03	-
10478934	10461414	12	12	082	.66	03	8
10478936	10461414	12	12	082	.66	03	8
10478937	10461360	24	11	082	.66	03	-
10478938	10461360	24	11	082	.66	03	-
10478939	10461358	24	12	308	.66	03	-
10478940	10461413	24	12	082	.66	03	3,8
10478941	10461358	24	12	308	.66	03	-
10478942	10461358	24	12	308	.66	03	-
10478943	10461360	24	11	082	.66	03	-
10478944	10461358	24	12	308	.66	03	-
10478945	10461412	24	12	052	.53	SP	8
10478946	10461360	24	11	082	.66	03	-
10478947	10461358	24	12	308	.66	03	-
10478952	10461360	24	11	082	.66	03	-
10478962	10461328	12	12	038	.53	01	-
10478965	10461079*	12	12	278	.66	03	2
10478966	10461166	12	12	270	.66	03	-
10478967	10461324*	12	12	285	.66	03	-
10478977	10461051	12	12	292	.66	03	2
10478978	10461132**	12	11	038	.66	03	-

Part Number	Reman Number	Volts	Pinion Teeth	Switch Pos.	Mtg. Hole	Nose Hsg.	Rem.
DELCO REMY O.E. PART NUMBERS (CONT.)							
10478979	10461140*	24	11	038	.66	03	2
10478980	10461068	24	11	038	.66	03	-
10478985	10461132**	12	11	038	.66	03	-
10478986	10461068	24	11	038	.66	03	-
10478988	10461360	24	11	082	.66	03	-
10478994	10461414	12	12	082	.66	03	8
10478995	10461358	24	12	308	.66	03	-
10478998	10461068	24	11	038	.66	03	-
10479003	10461051	12	12	292	.66	03	2
10479004	10461414	12	12	082	.66	03	8
10479006	10461326	12	11	082	.66	03	8
10479008	10461413	24	12	082	.66	03	3,8
10479009	10461358	24	12	308	.66	03	-
10479010	10461360	24	11	082	.66	03	-
10479012	10461412	24	12	052	.53	SP	8
10479017	10461411	12	11	088	.66	03	-
10479018	10461166	12	12	270	.66	03	-
10479019	10461324*	12	12	285	.66	03	-
10479021	10461415	12	11	068	.66	03	1
10479022	10461410	24	11	278	.66	03	1
10479026	10461162†	12	12	052	.53	03	-
10479027	10461163*†	12	12	052	.53	03	-
10479028	10461164†	12	11	082	.66	03	-
10479030	10461165†	12	11	082	.66	03	-
10479037	10461052	12	11	082	.66	03	-
10479038	10461055*	12	11	082	.66	03	-
10479040	10461151†	12	12	082	.66	03	3
10479041	10461172*†	12	12	082	.66	03	3
10479062	10461055*	12	11	082	.66	03	-
10479065	10461415	12	11	068	.66	03	1
10479072	10461052	12	11	082	.66	03	-
10479078	10461388*	12	12	128	.41	01	4,5
10479081	10461052	12	11	082	.66	03	-
10479082	10461055*	12	11	082	.66	03	-
10479100	10461410	24	11	278	.66	03	1
10479119	10461360	24	11	082	.66	03	-
10479120	10461358	24	12	308	.66	03	-
10479136	10461358	24	12	308	.66	03	-
10479149	10461360	24	11	082	.66	03	-
10479150	10461052	12	11	082	.66	03	-
10479154	10461265†	12	12	052	.53	03	-
10479155	10461266*†	12	12	052	.53	03	-
10479156	10461267†	12	11	082	.66	03	-
10479157	10461268†	12	11	082	.66	03	-
10479158	10461269†	12	12	082	.66	03	3
10479159	10461270*†	12	12	082	.66	03	3
10479160	10461271†	12	11	088	.66	03	-
10479161	10461272*†	12	11	088	.66	03	-
10479164	10461068	24	11	038	.66	03	-
10479168	10461410	24	11	278	.66	03	1
10479178	10461358	24	12	308	.66	03	-
10479191	10461328	12	12	038	.53	01	-
10479192	10461329*	12	12	038	.66	03	-
10479238	10461418	24	12	082	.53	03	1,6
10479251	10461501	12	12	082	.53	03	6
10479265	10462155	12	11	082	.66	03	-

REMANUFACTURED STARTERS



42MT (cont.)

Part Number	Reman Number	Volts	Pinion Teeth	Switch Pos.	Mtg. Hole	Nose Hsg.	Rem.
DELCO REMY O.E. PART NUMBERS (CONT.)							
10479266	10462196	12	11	052	.66	03	-
10479267	10462175	12	11	088	.66	03	-
10479277	10461052	12	11	082	.66	03	-
10479286	10461360	24	11	082	.66	03	-

AC DELCO CATALOG NUMBERS

323-829	10461051	12	12	292	.66	03	2
323-830	10461050	12	12	082	.66	03	1
323-854	10461020	12	11	068	.66	03	-
323-855	10461021	12	12	082	.66	03	-
323-856	10461132**	12	11	038	.66	03	-
323-857	10461132**	12	11	038	.66	03	-
323-858	10461068	24	11	038	.66	03	-
323-859	10461025	24	12	308	.66	03	-
323-864	10461055*	12	11	082	.66	03	-
323-865	10461137	24	13	322	.66	03	-
323-866	10461134	24	11	052	.66	03	-
323-867	10461052	12	11	082	.66	03	-
323-871	10461053	12	11	088	.66	03	7
323-872	10461054	24	11	088	.66	03	-
323-873	10461075*	12	11	088	.66	03	-
323-874	10461233*	12	12	082	.66	03	-
323-877	10461077	12	12	082	.66	03	3
323-878	10461141*	24	11	052	.66	03	-
323-882	10461091	12	12	082	.66	03	-
323-883	10461131	12	11	292	.66	03	2,3
323-889	10461172*†	12	12	082	.66	03	3
323-890	10461151†	12	12	082	.66	03	3
323-891	10461165†	12	11	082	.66	03	-
323-892	10461164†	12	11	082	.66	03	-
323-893	10461163*†	12	12	052	.53	03	-
323-894	10461162†	12	12	052	.53	03	-
323-898	10461078*	12	12	082	.66	03	3
323-902	10461096*	12	11	052	.66	03	-
323-922	10461324*	12	12	285	.66	03	-
323-924	10461326	12	11	082	.66	03	8
323-925	10461166	12	12	270	.66	03	-
323-926	10461079*	12	12	278	.66	03	2
323-927	10461135	24	11	292	.66	03	2
323-928	10461341	24	12	278	.66	03	-
323-930	10461353	24	11	038	.66	03	2
323-931	10461351	24	11	038	.53	03	2
323-932	10461140*	24	11	038	.66	03	2
323-933	10461358	24	12	308	.66	03	-
323-934	10461360	24	11	082	.66	03	-
323-937	10461410	24	11	278	.66	03	1
323-945	10461388*	12	12	128	.41	01	4,5
323-948	10461415	12	11	068	.66	03	1
323-949	10461411	12	11	088	.66	03	-
323-952	10461412	24	12	052	.53	SP	8
323-953	10461413	24	12	082	.66	03	3,8
323-954	10461414	12	12	082	.66	03	8
323-966	10461418	24	12	082	.53	03	1,6

Part Number	Reman Number	Volts	Pinion Teeth	Switch Pos.	Mtg. Hole	Nose Hsg.	Rem.
BERMAN PART NUMBERS							
DS-10	10461052	12	11	082	.66	03	-
DS-10	10461053	12	11	088	.66	03	7
DS-11	10461052	12	11	082	.66	03	-
DS-37	10461360	24	11	082	.66	03	-
DS-38	10461358	24	12	308	.66	03	-

CARGO PART NUMBERS

110999	10461358	24	12	308	.66	03	-
111000	10461068	24	11	038	.66	03	-

CUMMINS RECON PART NUMBERS

3604321RX	10461068	24	11	038	.66	03	-
3604322RX	10461052	12	11	082	.66	03	-
3604323RX	10461021	12	12	082	.66	03	-
3604324RX	10461132**	12	11	038	.66	03	-
3604484RX	10461358	24	12	308	.66	03	-
3604665RX	10461055*	12	11	082	.66	03	-
3604665RX	10461075*	12	11	088	.66	03	-
3604665RX	10461096*	12	11	052	.66	03	-
3675127RX	10461077	12	12	082	.66	03	3
3675128RX	10461078*	12	12	082	.66	03	3

DDC CATALOG NUMBERS

R0461126	10461052	12	11	082	.66	03	-
R0461127	10461053	12	11	088	.66	03	7
R0461132	10461132**	12	11	038	.66	03	-
R0461168	10461132**	12	11	038	.66	03	-
R0461183	10461055*	12	11	082	.66	03	-
R0461184	10461054	24	11	088	.66	03	-
R0461185	10461075*	12	11	088	.66	03	-
R0461194	10461132**	12	11	038	.66	03	-
R0461206	10461233*	12	12	082	.66	03	-
R0461217	10461134	24	11	052	.66	03	-
R0461339	10461341	24	12	278	.66	03	-

DDC PART NUMBERS

10461126	10461052	12	11	082	.66	03	-
10461127	10461053	12	11	088	.66	03	7
10461132	10461132**	12	11	038	.66	03	-
10461168	10461132**	12	11	038	.66	03	-
10461183	10461055*	12	11	082	.66	03	-
10461184	10461054	24	11	088	.66	03	-
10461185	10461075*	12	11	088	.66	03	-
10461194	10461132**	12	11	038	.66	03	-
10461206	10461233*	12	12	082	.66	03	-
10461217	10461134	24	11	052	.66	03	-
10461339	10461341	24	12	278	.66	03	-

DIXIE PART NUMBERS

S-1296	10461079*	12	12	278	.66	03	2
TS-1191	10461131	12	11	292	.66	03	2,3
TS-1500	10461050	12	12	082	.66	03	1
TS-1501	10461052	12	11	082	.66	03	-
TS-1501	10461591	12	11	278	.66	03	2,6
TS-1502	10461358	24	12	308	.66	03	-
TS-1503	10461358	24	12	308	.66	03	-
TS-1503	10461054	24	11	088	.66	03	-
TS-1502	10461025	24	12	308	.66	03	-

REMANUFACTURED STARTERS

42MT (cont.)

Part Number	Reman Number	Volts	Pinion Teeth	Switch Pos.	Mtg. Hole	Nose Hsg.	Rem.
DIXIE PART NUMBERS (CONT.)							
TS-1503	10461068	24	11	038	.66	03	-
TS-1504	10461051	12	12	292	.66	03	2
TS-1505	10461077	12	12	082	.66	03	3
TS-1506	10461132**	12	11	038	.66	03	-
TS-1509	10461413	24	12	082	.66	03	3,8
TS-1512	10461055*	12	11	082	.66	03	-
TS-1512	10461096*	12	11	052	.66	03	-
TS-1512	10461585*	12	11	278	.66	03	6
TS-1569	10461132**	12	11	038	.66	03	-
TS-1570	10461351	24	11	038	.53	03	2
TS-1570	10461134	24	11	052	.66	03	-
TS-1571	10461137	24	13	322	.66	03	-
TS-1597	10461020	12	11	068	.66	03	-
TS-1603	10461053	12	11	088	.66	03	7
TS-1604	10461075*	12	11	088	.66	03	-
TS-1605	10461078*	12	12	082	.66	03	3
TS-1611	10461233*	12	12	082	.66	03	-
TS-1612	10461141*	24	11	052	.66	03	-

MIDLAND PART NUMBERS							
RS142000X	10461068	24	11	038	.66	03	-
RS142001X	10461052	12	11	082	.66	03	-
RS142002X	10461050	12	12	082	.66	03	1
RS142003X	10461132**	12	11	038	.66	03	-
RS142005X	10461055*	12	11	082	.66	03	-
RS142006X	10461233*	12	12	082	.66	03	-
RS142007X	10461053	12	11	088	.66	03	7
RS142008X	10461077	12	12	082	.66	03	3
RS142015X	10461051	12	12	292	.66	03	2
RS142020X	10461050	12	12	082	.66	03	1
RS142021X	10461054	24	11	088	.66	03	-
RS142022X	10461075*	12	11	088	.66	03	-
RS142023X	10461078*	12	12	082	.66	03	3
RS142024X	10461077	12	12	082	.66	03	3
RS142025X	10461166	12	12	270	.66	03	-
RS142026X	10461096*	12	11	052	.66	03	-
RS142027X	10461134	24	11	052	.66	03	-

Part Number	Reman Number	Volts	Pinion Teeth	Switch Pos.	Mtg. Hole	Nose Hsg.	Rem.
WILSON PART NUMBERS							
91-01-4151	10461052	12	11	082	.66	03	-
91-01-4152	10461077	12	12	082	.66	03	3
91-01-4153	10461413	24	12	082	.66	03	3,8
91-01-4154	10461414	12	12	082	.66	03	8
91-01-4157	10461068	24	11	038	.66	03	-
91-01-4158	10461358	24	12	308	.66	03	-
91-01-4158	10461025	24	12	308	.66	03	-
91-01-4159	10461054	24	11	088	.66	03	-
91-01-4159	10461068	24	11	038	.66	03	-
91-01-4160	10461132**	12	11	038	.66	03	-
91-01-4161	10461021	12	12	082	.66	03	-
91-01-4161	10461050	12	12	082	.66	03	1
91-01-4161	10461051	12	12	292	.66	03	2
91-01-4161	10461162†	12	12	052	.53	03	-
91-01-4163	10461051	12	12	292	.66	03	2
91-01-4166	10461164†	12	11	082	.66	03	-
91-01-4166	10461052	12	11	082	.66	03	-
91-01-4166	10461053	12	11	088	.66	03	7
91-01-4290	10461137	24	13	322	.66	03	-
91-01-4295	10461055*	12	11	082	.66	03	-
91-01-4295	10461096*	12	11	052	.66	03	-
91-01-4296	10461075*	12	11	088	.66	03	-
91-01-4297	10461020	12	11	068	.66	03	-
91-01-4298	10461358	24	12	308	.66	03	-
91-01-4330	10461233*	12	12	082	.66	03	-
91-01-4330	10461079*	12	12	278	.66	03	2
91-01-4331	10461591	12	11	278	.66	03	2,6
91-01-4334	10461414	12	12	082	.66	03	8
91-01-4347	10461136	24	12	308	.53	03	-
91-01-4349	10461131	12	11	292	.66	03	2,3
91-01-4350	10461132**	12	11	038	.66	03	-
91-01-4351	10461135	24	11	292	.66	03	2
91-01-4372	10461412	24	12	052	.53	SP	8
91-01-4400	10461358	24	12	308	.66	03	-
91-01-4405	10461132**	12	11	038	.66	03	-
91-01-4407	10461233*	12	12	082	.66	03	-
91-01-4411	10461078*	12	12	082	.66	03	3
91-01-4420	10461055*	12	11	082	.66	03	-
91-01-4427	10461414	12	12	082	.66	03	8
91-01-4436	10461360	24	11	082	.66	03	-
91-01-4460	10461585*	12	11	278	.66	03	6

Remanufactured Starters

REMANUFACTURED STARTERS



50MT



SAE No 3 Flange
180° Flywheel Opening

SAE No 3 Flange
145° Flywheel Opening

Remarks

1. 145° Nose Housing Opening
2. 215° Nose Housing
3. Provisions for Mounting Shield
4. Nose Piece w/15° Mounting Pos. Offset by 6°

Part Number	Reman Number	Volts	Pinion Teeth	Switch Pos.	Mtg. Hole	Nose Hsg.	Rem.
DELCO REMY REMANUFACTURED PART NUMBERS							
1109555	1109555	24	11	038	.66	SP	-
1109792	1109792	24	12	158	.66	SP	2
1109793	1109793	24	11	068	.66	SP	2
1109795	1109795	24	12	068	.66	03	-
10461493	10461493	24	11	322	.66	03	-
10461159	10461159	32	11	308	.66	03	-
10461160	10461160	64	11	308	.66	03	-
10461161	10461161	32	11	308	.66	03	-
10461167	10461167	64	11	308	.66	03	-
10461382	10461382	24	11	038	.66	03	1
10461499	10461499	24	11	038	.66	03	-
10461586	10461586	24	11	38	.66	03	-
10461731	10461731	12	11	82	.66	03	-
10461732	10461732	24	11	38	.66	SP	-
10461733	10461733	24	11	38	.66	03	-
10461734	10461734	24	12	158	.66	SP	-
10461735	10461735	24	11	68	.66	SP	-
10461737	10461737	24	12	158	.66	SP	-
10461738	10461738	12	11	82	.66	03	-
10461739	10461739	24	11	38	.66	03	-
10461740	10461740	24	11	38	.66	03	-
10461741	10461741	12	11	38	.66	03	-
10461744	10461744	24	11	82	.66	03	3
10461745	10461745	24	11	52	.66	SP	-
10461746	10461746	24	11	68	.66	03	-
10461747	10461747	24	11	88	.66	03	4
10461748	10461748	24	12	308	.66	03	-
10461749	10461749	24	11	322	.66	03	-

DELCO REMY O.E. PART NUMBERS

1109222	10461057	24	11	038	.66	03	-
1109273	1109555	24	11	038	.66	SP	-
1109279	10461159	32	11	308	.66	03	-
1109280	10461159	32	11	308	.66	03	-
1109284	10461160	64	11	308	.66	03	-
1109285	10461057	24	11	038	.66	03	-
1109286	10461057	24	11	038	.66	03	-
1109287	10461057	24	11	038	.66	03	-
1109288	10461057	24	11	038	.66	03	-
1109289	10461057	24	11	038	.66	03	-
1109290	10461057	24	11	038	.66	03	-
1109291	10461057	24	11	038	.66	03	-

Part Number	Reman Number	Volts	Pinion Teeth	Switch Pos.	Mtg. Hole	Nose Hsg.	Rem.
DELCO REMY O.E. PART NUMBERS (CONT.)							
1109292	10461057	24	11	038	.66	03	-
1109293	10461057	24	11	038	.66	03	-
1109294	1109793	24	11	068	.66	SP	2
1109295	10461056	12	11	082	.66	03	-
1109296	10461057	24	11	038	.66	03	-
1109297	10461499	24	11	038	.66	03	-
1109298	10461057	24	11	038	.66	03	-
1109493	10461382	24	11	038	.66	03	1
1109494	10461057	24	11	038	.66	03	-
1109497	1109555	24	11	038	.66	SP	-
1109545	10461056	12	11	082	.66	03	-
1109553	10461057	24	11	038	.66	03	-
1109554	10461056	12	11	082	.66	03	-
1109624	1109795	24	12	068	.66	03	-
1109625	10461161	32	11	308	.66	03	-
1109628	1109795	24	12	068	.66	03	-
1109629	10461160	64	11	308	.66	03	-
1109630	10461382	24	11	038	.66	03	1
1109631	10461057	24	11	038	.66	03	-
1109632	1109555	24	11	038	.66	SP	-
1109633	1109793	24	11	068	.66	SP	2
1109634	1109795	24	12	068	.66	03	-
1109636	10461057	24	11	038	.66	03	-
1109637	1109795	24	12	068	.66	03	-
1109638	10461057	24	11	038	.66	03	-
1109640	1109795	24	12	068	.66	03	-
1109641	10461737	24	12	158	.66	SP	-
1109641	10461735	24	11	68	.66	SP	-
1109641	1109793	24	11	068	.66	SP	2
1109642	10461057	24	11	038	.66	03	-
1109643	10461057	24	11	038	.66	03	-
1109644	1109793	24	11	068	.66	SP	2
1109645	1109795	24	12	068	.66	03	-
1109646	10461382	24	11	038	.66	03	1
1109647	10461057	24	11	038	.66	03	-
1109648	10461499	24	11	038	.66	03	-
1109649	10461057	24	11	038	.66	03	-
1109755	10461057	24	11	038	.66	03	-
1109756	1109793	24	11	068	.66	SP	2
1109757	1109792	24	12	158	.66	SP	2
1109758	10461167	64	11	308	.66	03	-
1109759	10461057	24	11	038	.66	03	-
1109768	10461057	24	11	038	.66	03	-

Remanufactured Starters

REMANUFACTURED STARTERS

50MT (cont.)

Part Number	Reman Number	Volts	Pinion Teeth	Switch Pos.	Mtg. Hole	Nose Hsg.	Rem.	Part Number	Reman Number	Volts	Pinion Teeth	Switch Pos.	Mtg. Hole	Nose Hsg.	Rem.
DELCO REMY O.E. PART NUMBERS (CONT.)								DELCO REMY O.E. PART NUMBERS (CONT.)							
1109770	1109792	24	12	158	.66	SP	2	1109979	10461057	24	11	038	.66	03	-
1109771	10461057	24	11	038	.66	03	-	1109984	10461159	32	11	308	.66	03	-
1109772	10461057	24	11	038	.66	03	-	1109986	10461057	24	11	038	.66	03	-
1109773	10461057	24	11	038	.66	03	-	1109987	10461057	24	11	038	.66	03	-
1109774	10461057	24	11	038	.66	03	-	1109997	1109793	24	11	068	.66	SP	2
1109775	10461057	24	11	038	.66	03	-	1109998	1109795	24	12	068	.66	03	-
1109776	10461057	24	11	038	.66	03	-	1990227	1109793	24	11	068	.66	SP	2
1109777	10461057	24	11	038	.66	03	-	1990228	1109795	24	12	068	.66	03	-
1109778	10461057	24	11	038	.66	03	-	1990229	10461057	24	11	038	.66	03	-
1109780	10461057	24	11	038	.66	03	-	1990231	10461057	24	11	038	.66	03	-
1109781	10461732	24	11	38	.66	SP	-	1990232	1109792	24	12	158	.66	SP	2
1109781	1109555	24	11	038	.66	SP	-	1990233	1109555	24	11	038	.66	SP	-
1109782	10461057	24	11	038	.66	03	-	1990234	1109555	24	11	038	.66	SP	-
1109787	10461057	24	11	038	.66	03	-	1990235	10461057	24	11	038	.66	03	-
1109788	1109555	24	11	038	.66	SP	-	1990236	10461499	24	11	038	.66	03	-
1109789	1109555	24	11	038	.66	SP	-	1990237	10461057	24	11	038	.66	03	-
1109790	10461731	12	11	82	.66	03	-	1990238	1109793	24	11	068	.66	SP	2
1109790	10461056	12	11	082	.66	03	-	1990239	10461057	24	11	038	.66	03	-
1109791	10461057	24	11	038	.66	03	-	1990240	1109792	24	12	158	.66	SP	2
1109792	10461734	24	12	158	.66	SP	-	1990243	1109795	24	12	068	.66	03	-
1109796	10461161	32	11	308	.66	03	-	1990244	10461382	24	11	038	.66	03	1
1109797	10461159	32	11	308	.66	03	-	1990246	10461159	32	11	308	.66	03	-
1109798	10461382	24	11	038	.66	03	1	1990247	1109792	24	12	158	.66	SP	2
1109799	10461499	24	11	038	.66	03	-	1990248	10461057	24	11	038	.66	03	-
1109830	10461499	24	11	038	.66	03	-	1990249	10461057	24	11	038	.66	03	-
1109831	10461057	24	11	038	.66	03	-	1990250	10461057	24	11	038	.66	03	-
1109833	1109555	24	11	038	.66	SP	-	1990251	10461057	24	11	038	.66	03	-
1109834	1109555	24	11	038	.66	SP	-	1990258	10461160	64	11	308	.66	03	-
1109835	1109793	24	11	068	.66	SP	2	1990259	10461057	24	11	038	.66	03	-
1109836	1109555	24	11	038	.66	SP	-	1990260	10461057	24	11	038	.66	03	-
1109837	10461382	24	11	038	.66	03	1	1990261	10461056	12	11	082	.66	03	-
1109838	10461057	24	11	038	.66	03	-	1990262	10461057	24	11	038	.66	03	-
1109839	10461057	24	11	038	.66	03	-	1990263	10461057	24	11	038	.66	03	-
1109840	10461057	24	11	038	.66	03	-	1990264	10461057	24	11	038	.66	03	-
1109841	10461057	24	11	038	.66	03	-	1990265	10461499	24	11	038	.66	03	-
1109842	10461057	24	11	038	.66	03	-	1990266	10461057	24	11	038	.66	03	-
1109843	10461057	24	11	038	.66	03	-	1990267	10461382	24	11	038	.66	03	1
1109844	10461382	24	11	038	.66	03	1	1990268	10461057	24	11	038	.66	03	-
1109845	10461057	24	11	038	.66	03	-	1990269	10461740	24	11	38	.66	03	-
1109846	10461057	24	11	038	.66	03	-	1990269	10461057	24	11	038	.66	03	-
1109847	1109795	24	12	068	.66	03	-	1990270	10461057	24	11	038	.66	03	-
1109848	1109795	24	12	068	.66	03	-	1990271	10461057	24	11	038	.66	03	-
1109849	1109792	24	12	158	.66	SP	2	1990272	10461057	24	11	038	.66	03	-
1109884	10461159	32	11	308	.66	03	-	1990273	10461057	24	11	038	.66	03	-
1109961	10461057	24	11	038	.66	03	-	1990274	10461057	24	11	038	.66	03	-
1109962	10461499	24	11	038	.66	03	-	1990275	10461159	32	11	308	.66	03	-
1109963	10461159	32	11	308	.66	03	-	1990276	10461057	24	11	038	.66	03	-
1109965	10461057	24	11	038	.66	03	-	1990277	10461741	12	11	38	.66	03	-
1109969	1109793	24	11	068	.66	SP	2	1990277	10461056	12	11	082	.66	03	-
1109971	10461733	24	11	38	.66	03	-	1990278	10461382	24	11	038	.66	03	1
1109971	10461382	24	11	038	.66	03	1	1990284	10461057	24	11	038	.66	03	-
1109972	10461057	24	11	038	.66	03	-	1990291	1109555	24	11	038	.66	SP	-
1109973	10461057	24	11	038	.66	03	-	1990298	10461056	12	11	082	.66	03	-
1109977	10461057	24	11	038	.66	03	-	1990333	10461161	32	11	308	.66	03	-
1109978	10461057	24	11	038	.66	03	-	1993739	10461407	24	12	308	.66	03	-
1109979	10461739	24	11	38	.66	03	-	1993740	10461160	64	11	308	.66	03	-

REMANUFACTURED STARTERS



50MT (cont.)

Part Number	Reman Number	Volts	Pinion Teeth	Switch Pos.	Mtg. Hole	Nose Hsg.	Rem.
-------------	--------------	-------	--------------	-------------	-----------	-----------	------

DELCO REMY O.E. PART NUMBERS (CONT.)

1993743	10461167	64	11	308	.66	03	-
1993753	1109555	24	11	038	.66	SP	-
1993781	1109792	24	12	158	.66	SP	2
1993798	10461160	64	11	308	.66	03	-
1993839	10461407	24	12	308	.66	03	-
1993847	10461407	24	12	308	.66	03	-
1993860	10461406	24	11	088	.66	03	-
1993864	10461056	12	11	082	.66	03	-
1993989	10461407	24	12	308	.66	03	-
8200016	10461744	24	11	82	.66	03	3
10461056	10461056	12	11	082	.66	03	-
10461125	10461739	24	11	38	.66	03	-
10461129	10461056	12	11	082	.66	03	-
10461157	10461744	24	11	82	.66	03	3
10461158	10461407	24	12	308	.66	03	-
10461191	10461738	24	11	82	.66	03	-
10461368	10461160	64	11	308	.66	03	-
10461369	10461167	64	11	308	.66	03	-
10461377	10461744	24	11	82	.66	03	3
10461378	10461744	24	11	82	.66	03	3
10461381	10461382	24	11	038	.66	03	1
10461400	10461748	24	12	308	.66	03	-
10461401	10461747	24	11	88	.66	03	4
10461406	10461747	24	11	88	.66	03	4
10461407	10461748	24	12	308	.66	03	-
10478807	10461160	64	11	308	.66	03	-
10478808	10461160	64	11	308	.66	03	-
10478813	10461056	12	11	082	.66	03	-
10478829	10461160	64	11	308	.66	03	-
10478830	10461167	64	11	308	.66	03	-
10478847	10461407	24	12	308	.66	03	-
10478848	10461378	24	11	082	.66	03	-
10478860	10461407	24	12	308	.66	03	-
10478863	10461378	24	11	082	.66	03	-
10478864	10461407	24	12	308	.66	03	-
10478865	10461378	24	11	082	.66	03	-
10478866	10461378	24	11	082	.66	03	-
10478869	10461407	24	12	308	.66	03	-
10478877	10461056	12	11	082	.66	03	-
10478879	10461382	24	11	038	.66	03	1
10478880	10461057	24	11	038	.66	03	-
10478882	10461747	24	11	88	.66	03	4
10478882	10461406	24	11	088	.66	03	-
10478903	10461407	24	12	308	.66	03	-
10478904	10461056	12	11	082	.66	03	-
10478905	10461382	24	11	038	.66	03	1
10478906	10461056	12	11	082	.66	03	-
10478908	10461378	24	11	082	.66	03	-
10478910	10461056	12	11	082	.66	03	-
10478911	10461057	24	11	038	.66	03	-
10478916	10461160	64	11	308	.66	03	-
10478919	10461160	64	11	308	.66	03	-
10479144	10461745	24	11	52	.66	SP	-
10479145	10461378	24	11	082	.66	03	-
10479153	10461493	24	11	322	.66	03	-
10479190	10461378	24	11	082	.66	03	-

Part Number	Reman Number	Volts	Pinion Teeth	Switch Pos.	Mtg. Hole	Nose Hsg.	Rem.
-------------	--------------	-------	--------------	-------------	-----------	-----------	------

DELCO REMY O.E. PART NUMBERS (CONT.)

10479199	10461493	24	11	322	.66	03	-
10479200	10461749	24	11	322	.66	03	-
10479200	10461493	24	11	322	.66	03	-
10479218	10461586	24	11	038	.66	03	2
10479323	10461739	24	11	38	.66	03	-
10479327	10461499	24	11	038	.66	03	-
10479328	10461738	24	11	82	.66	03	-
10479331	10461159	32	11	308	.66	03	-
10479335	10461382	24	11	038	.66	03	1
10479336	10461738	24	11	82	.66	03	-
10479338	10461738	12	11	82	.66	03	-
10479343	10461744	24	11	82	.66	03	3
10479344	10461493	24	11	322	.66	03	-

AC DELCO CATALOG NUMBERS

323-761	10461057	24	11	038	.66	03	-
323-762	1109792	24	12	158	.66	SP	2
323-763	1109793	24	11	068	.66	SP	2
323-765	1109795	24	12	068	.66	03	-
323-766	10461161	32	11	308	.66	03	-
323-767	10461159	32	11	308	.66	03	-
323-769	10461499	24	11	038	.66	03	-
323-789	10461056	12	11	082	.66	03	-
323-790	1109555	24	11	038	.66	SP	-
323-938	10461160	64	11	308	.66	03	-
323-939	10461167	64	11	308	.66	03	-
323-942	10461378	24	11	082	.66	03	-
323-944	10461382	24	11	038	.66	03	1
323-956	10461407	24	12	308	.66	03	-
323-957	10461406	24	11	088	.66	03	-

BERMAN PART NUMBERS

DS-12	10461057	24	11	038	.66	03	-
DS-14	1109792	24	12	158	.66	SP	2
DS-15	1109793	24	11	068	.66	SP	2
DS-16	1109795	24	12	068	.66	03	-

CARGO PART NUMBERS

110347	10461057	24	11	038	.66	03	-
--------	-----------------	----	----	-----	-----	----	---

CUMMINS RECON PART NUMBERS

3604645RX	1109555	24	11	038	.66	SP	-
3604645RX	1109792	24	12	158	.66	SP	2
3604655RX	1109793	24	11	068	.66	SP	2
3603868RX	10461057	24	11	038	.66	03	-
3604680RX	10461056	12	11	082	.66	03	-
3604690RX	1109795	24	12	068	.66	03	-

DDC CATALOG NUMBERS

R0461125	10461057	24	11	038	.66	03	-
R0461129	10461056	12	11	082	.66	03	-

DDC PART NUMBERS

10461125	10461057	24	11	038	.66	03	-
10461129	10461056	12	11	082	.66	03	-

50MT (cont.)

Part Number	Reman Number	Volts	Pinion Teeth	Switch Pos.	Mtg. Hole	Nose Hsg.	Rem.
DIXIE PART NUMBERS							
S-1293	10461056	12	11	082	.66	03	-
TS-1061	10461057	24	11	038	.66	03	-
TS-1061	10461382	24	11	038	.66	03	1
TS-1207	1109792	24	12	158	.66	SP	2
TS-1252	10461407	24	12	308	.66	03	-
TS-1268	10461159	32	11	308	.66	03	-
TS-1268	10461161	32	11	308	.66	03	-
TS-1298	10461159	32	11	308	.66	03	-
TS-1298	10461161	32	11	308	.66	03	-
TS-1388	10461499	24	11	038	.66	03	-
TS-1452	1109555	24	11	038	.66	SP	-
TS-1596	10461382	24	11	038	.66	03	1
TS-1613	10461056	12	11	082	.66	03	-
TS-1614	10461406	24	11	088	.66	03	-
TS-1615	10461160	64	11	308	.66	03	-
TS-1616	10461160	64	11	308	.66	03	-
TS-1616	10461167	64	11	308	.66	03	-

MIDLAND PART NUMBERS							
RS150001X	1109795	24	12	068	.66	03	-
RS150001X	10461407	24	12	308	.66	03	-
RS150002X	10461057	24	11	038	.66	03	-

Part Number	Reman Number	Volts	Pinion Teeth	Switch Pos.	Mtg. Hole	Nose Hsg.	Rem.
MIDLAND PART NUMBERS (CONT.)							
RS150003X	1109792	24	12	158	.66	SP	2
RS150004X	1109793	24	11	068	.66	SP	2
RS150005X	10461057	24	11	038	.66	03	-
RS150010X	10461056	12	11	082	.66	03	-
RS150011X	10461159	32	11	308	.66	03	-
RS150011X	10461161	32	11	308	.66	03	-
RS150012X	10461160	64	11	308	.66	03	-
RS150013X	10461161	32	11	308	.66	03	-

WILSON PART NUMBERS							
91-01-3767	10461382	24	11	038	.66	03	1
91-01-3948	10461057	24	11	038	.66	03	-
91-01-4062	1109792	24	12	158	.66	SP	2
91-01-4074	10461161	32	11	308	.66	03	-
91-01-4107	10461056	12	11	082	.66	03	-
91-01-4108	10461057	24	11	038	.66	03	-
91-01-4109	10461407	24	12	308	.66	03	-
91-01-4111	1109555	24	11	038	.66	SP	-
91-01-4286	10461159	32	11	308	.66	03	-
91-01-4357	10461499	24	11	038	.66	03	-
91-01-4428	10461378	24	11	082	.66	03	-
91-01-4438	10461161	32	11	308	.66	03	-

Bosch 10461622



Part Number	Reman Number	Volts	Pinion Teeth	Type	Kw
DELCO REMY REMANUFACTURED PART NUMBER					
10461622	10461622	12	10	DD	3.0

BOSCH O.E. NUMBERS					
0-001-359-016	10461622	12	10	DD	3.0
0-001-359-090	10461622	12	10	DD	3.0
0-001-367-075	10461622	12	10	DD	3.0
0-001-367-078	10461622	12	10	DD	3.0
0-001-369-001	10461622	12	10	DD	3.0
0-001-369-005	10461622	12	10	DD	3.0

Part Number	Reman Number	Volts	Pinion Teeth	Type	Kw
DIXIE PART NUMBERS					
TS-6010	10461622	12	10	DD	3.0
TS-6146	10461622	12	10	DD	3.0

LESTER PART NUMBER					
16563	10461622	12	10	DD	3.0

WILSON PART NUMBER					
91-15-6872	10461622	12	10	DD	3.0

REMANUFACTURED STARTERS



Bosch 10461637



Part Number	Reman Number	Volts	Pinion Teeth	Type	Kw
-------------	--------------	-------	--------------	------	----

DELCO REMY REMANUFACTURED PART NUMBER

10461637	10461637	12	9	DD	2.7
----------	-----------------	----	---	----	-----

BOSCH O.E. NUMBERS

0-001-362-016	10461637	12	9	DD	2.7
0-001-362-034	10461637	12	9	DD	2.7
0-001-362-305	10461637	12	9	DD	2.7

Part Number	Reman Number	Volts	Pinion Teeth	Type	Kw
-------------	--------------	-------	--------------	------	----

DIXIE PART NUMBER

TS-6022	10461637	12	9	DD	2.7
---------	-----------------	----	---	----	-----

LESTER PART NUMBER

17075	10461637	12	9	DD	2.7
-------	-----------------	----	---	----	-----

WILSON PART NUMBER

91-15-6896	10461637	12	9	DD	2.7
------------	-----------------	----	---	----	-----

Bosch 10461638



Part Number	Reman Number	Volts	Pinion Teeth	Type	Kw
-------------	--------------	-------	--------------	------	----

DELCO REMY REMANUFACTURED PART NUMBER

10461638	10461638	12	10	DD	2.7
----------	-----------------	----	----	----	-----

BOSCH O.E. NUMBERS

0-001-362-310	10461638	12	10	DD	2.7
0-001-362-527	10461638	12	10	DD	2.7

DIXIE PART NUMBER

TS-6051	10461638	12	10	DD	2.7
---------	-----------------	----	----	----	-----

Part Number	Reman Number	Volts	Pinion Teeth	Type	Kw
-------------	--------------	-------	--------------	------	----

LESTER PART NUMBER

17077	10461638	12	10	DD	2.7
-------	-----------------	----	----	----	-----

WILSON PART NUMBER

91-15-6995	10461638	12	10	DD	2.7
------------	-----------------	----	----	----	-----

Bosch 10461639



Part Number	Reman Number	Volts	Pinion Teeth	Type	Kw
-------------	--------------	-------	--------------	------	----

DELCO REMY REMANUFACTURED PART NUMBER

10461639	10461639	12	10	DD	2.7
----------	-----------------	----	----	----	-----

BOSCH O.E. NUMBERS

0-001-362-312	10461639	12	10	DD	2.7
0-001-362-316	10461639	12	10	DD	2.7

Part Number	Reman Number	Volts	Pinion Teeth	Type	Kw
-------------	--------------	-------	--------------	------	----

DIXIE PART NUMBER

TS-6145	10461639	12	10	DD	2.7
---------	-----------------	----	----	----	-----

LESTER PART NUMBER

17095	10461639	12	10	DD	2.7
-------	-----------------	----	----	----	-----

WILSON PART NUMBER

91-15-6872	10461639	12	10	DD	2.7
------------	-----------------	----	----	----	-----

Ford 10459554



Part Number	Reman Number	Volts	Pinion Teeth	Type	Kw
-------------	--------------	-------	--------------	------	----

DELCO REMY REMANUFACTURED PART NUMBER

10459554	10459554	12	9	DD	NA
----------	-----------------	----	---	----	----

FORD O.E. NUMBER

B5CF11002C	10459554	12	9	DD	NA
------------	-----------------	----	---	----	----

Part Number	Reman Number	Volts	Pinion Teeth	Type	Kw
-------------	--------------	-------	--------------	------	----

WILSON PART NUMBER

91-02-5784	10459554	12	9	DD	NA
------------	-----------------	----	---	----	----

Ford 10461663



Part Number	Reman Number	Volts	Pinion Teeth	Type	Kw
-------------	--------------	-------	--------------	------	----

DELCO REMY REMANUFACTURED PART NUMBER

10461663	10461663	6	9	DD	NA
----------	-----------------	---	---	----	----

FORD O.E. NUMBERS

8N11001	10461663	6	9	DD	NA
9N11001	10461663	6	9	DD	NA
9N11002	10461663	6	9	DD	NA
SA-546	10461663	6	9	DD	NA

Part Number	Reman Number	Volts	Pinion Teeth	Type	Kw
-------------	--------------	-------	--------------	------	----

DIXIE PART NUMBER

TS-2000	10461663	6	9	DD	NA
---------	-----------------	---	---	----	----

LESTER PART NUMBER

3109	10461663	6	9	DD	NA
------	-----------------	---	---	----	----

WILSON PART NUMBER

91-02-5783	10461663	6	9	DD	NA
------------	-----------------	---	---	----	----

Ford 10461664



Part Number	Reman Number	Volts	Pinion Teeth	Type	Kw
-------------	--------------	-------	--------------	------	----

DELCO REMY REMANUFACTURED PART NUMBER

10461664	10461664	12	10	DD	NA
----------	-----------------	----	----	----	----

FORD O.E. NUMBERS

C5NF11001B	10461664	12	10	DD	NA
C7NF11001B	10461664	12	10	DD	NA
D0NF11001A	10461664	12	10	DD	NA
D1NN11001A	10461664	12	10	DD	NA
D7NN11001A	10461664	12	10	DD	NA
SA-640	10461664	12	10	DD	NA

Part Number	Reman Number	Volts	Pinion Teeth	Type	Kw
-------------	--------------	-------	--------------	------	----

DIXIE PART NUMBER

S-2014	10461664	12	10	DD	NA
--------	-----------------	----	----	----	----

LESTER PART NUMBER

3139	10461664	12	10	DD	NA
------	-----------------	----	----	----	----

WILSON PART NUMBER

91-02-5799	10461664	12	10	DD	NA
------------	-----------------	----	----	----	----

REMANUFACTURED STARTERS



Ford 10461705



Part Number	Reman Number	Volts	Pinion Teeth	Type	Kw
-------------	--------------	-------	--------------	------	----

DELCO REMY REMANUFACTURED PART NUMBER

10461705	10461705	12	9	DD	NA
----------	-----------------	----	---	----	----

FORD O.E. NUMBERS

B5C11002	10461705	12	9	DD	NA
C3NF11001A	10461705	12	9	DD	NA
C3NF11002D	10461705	12	9	DD	NA
FAC11002B	10461705	12	9	DD	NA
FAC11002G	10461705	12	9	DD	NA

Part Number	Reman Number	Volts	Pinion Teeth	Type	Kw
-------------	--------------	-------	--------------	------	----

DIXIE PART NUMBER

S-2009	10461705	12	9	DD	NA
--------	-----------------	----	---	----	----

LESTER PART NUMBER

3123	10461705	12	9	DD	NA
------	-----------------	----	---	----	----

WILSON PART NUMBERS

91-02-5792	10461705	12	9	DD	NA
91-02-5794	10461705	12	9	DD	NA

Ford 10461706



Part Number	Reman Number	Volts	Pinion Teeth	Type	Kw
-------------	--------------	-------	--------------	------	----

DELCO REMY REMANUFACTURED PART NUMBER

10461706	10461706	12	9	DD	NA
----------	-----------------	----	---	----	----

FORD O.E. NUMBER

C3NF11001C	10461706	12	9	DD	NA
------------	-----------------	----	---	----	----

DIXIE PART NUMBER

TS-2001	10461706	12	9	DD	NA
---------	-----------------	----	---	----	----

Part Number	Reman Number	Volts	Pinion Teeth	Type	Kw
-------------	--------------	-------	--------------	------	----

LESTER PART NUMBER

3136	10461706	12	9	DD	NA
------	-----------------	----	---	----	----

WILSON PART NUMBER

91-02-5784	10461706	12	9	DD	NA
------------	-----------------	----	---	----	----

Hitachi 10461621



Part Number	Reman Number	Volts	Pinion Teeth	Type	Kw
-------------	--------------	-------	--------------	------	----

DELCO REMY REMANUFACTURED PART NUMBER

10461621	10461621	12	9	DD	0.8
----------	-----------------	----	---	----	-----

HITACHI O.E. NUMBERS

S114-87	10461621	12	9	DD	0.8
S114-87K	10461621	12	9	DD	0.8
S114-55	10461621	12	9	DD	0.8
S114-87L	10461621	12	9	DD	0.8
S114-87N	10461621	12	9	DD	0.8
S114-87P	10461621	12	9	DD	0.8

Part Number	Reman Number	Volts	Pinion Teeth	Type	Kw
-------------	--------------	-------	--------------	------	----

DIXIE PART NUMBER

S-8022	10461621	12	9	DD	0.8
--------	-----------------	----	---	----	-----

LESTER PART NUMBER

16211	10461621	12	9	DD	0.8
-------	-----------------	----	---	----	-----

WILSON PART NUMBER

91-25-1000	10461621	12	9	DD	0.8
------------	-----------------	----	---	----	-----

Hitachi 10461659



Part Number	Reman Number	Volts	Pinion Teeth	Type	Kw
DELCO REMY REMANUFACTURED PART NUMBER					
10461659	10461659	12	NA	GR	2.0
HITACHI O.E. NUMBERS					
S13-94	10461659	12	NA	GR	2.0
S13-94A	10461659	12	NA	GR	2.0

Part Number	Reman Number	Volts	Pinion Teeth	Type	Kw
DIXIE PART NUMBER					
S-8488	10461659	12	NA	GR	2.0
LESTER PART NUMBER					
18051	10461659	12	NA	GR	2.0
WILSON PART NUMBER					
91-25-1072	10461659	12	NA	GR	2.0

Hitachi 10461660



Part Number	Reman Number	Volts	Pinion Teeth	Type	Kw
DELCO REMY REMANUFACTURED PART NUMBER					
10461660	10461660	12	8	DD	0.9
HITACHI O.E. NUMBERS					
S114-443	10461660	12	8	DD	0.9
S114-443A	10461660	12	8	DD	0.9
S114-653B	10461660	12	8	DD	0.9

Part Number	Reman Number	Volts	Pinion Teeth	Type	Kw
LESTER PART NUMBER					
18055	10461660	12	8	DD	0.9
WILSON PART NUMBER					
91-25-1109	10461660	12	8	DD	0.9

REMANUFACTURED STARTERS



Hitachi 10465437



Part Number	Reman Number	Volts	Pinion Teeth	Type	Kw
DELCO REMY REMANUFACTURED PART NUMBER					
10465437	10465437	12	9	OSGR	2.0
HITACHI O.E. NUMBER					
S13-84	10465437	12	9	OSGR	2.0
S13-84A	10465437	12	9	OSGR	2.0
S13-84B	10465437	12	9	OSGR	2.0
AC DELCO CATALOG NUMBER					
323-969	10465437	12	9	OSGR	2.0
CARRIER PART NUMBER					
20-45-1285	10465437	12	9	OSGR	2.0

Part Number	Reman Number	Volts	Pinion Teeth	Type	Kw
CUMMINS RECON PART NUMBER					
3675149RX	10465437	12	9	OSGR	2.0
DIXIE PART NUMBER					
S-8309	10465437	12	9	OSGR	2.0
LESTER PART NUMBER					
17088	10465437	12	9	OSGR	2.0
THERMO KING PART NUMBERS					
45-1285	10465437	12	9	OSGR	2.0
45-1229	10465437	12	9	OSGR	2.0
WILSON PART NUMBER					
91-25-1037	10465437	12	9	OSGR	2.0

Hitachi 10465438

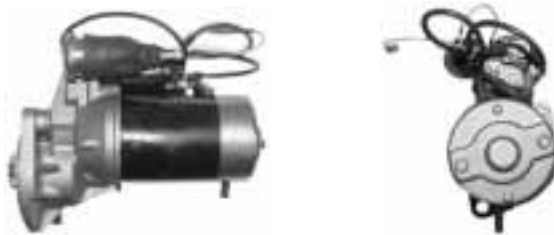

Part Number	Reman Number	Volts	Pinion Teeth	Type	Kw
DELCO REMY REMANUFACTURED PART NUMBER					
10465438	10465438	12	9	OSGR	2.0
HITACHI O.E. NUMBERS					
S13-89A	10465438	12	9	OSGR	2.0
S13-89B	10465438	12	9	OSGR	2.0
S13-89C	10465438	12	9	OSGR	2.0
S13-211	10465438	12	9	OSGR	2.0
S13-289	10465438	12	9	OSGR	2.0
S13-289A	10465438	12	9	OSGR	2.0
S13-89D	10465438	12	9	OSGR	2.0
AC DELCO CATALOG NUMBER					
323-970	10465438	12	9	OSGR	2.0
CARRIER PART NUMBERS					
20-45-1263	10465438	12	9	OSGR	2.0
20-45-1671	10465438	12	9	OSGR	2.0

Part Number	Reman Number	Volts	Pinion Teeth	Type	Kw
CUMMINS RECON PART NUMBER					
3675148RX	10465438	12	9	OSGR	2.0
DIXIE PART NUMBER					
S-8315	10465438	12	9	OSGR	2.0
LESTER PART NUMBER					
18067	10465438	12	9	OSGR	2.0
THERMO KING PART NUMBER					
45-1263	10465438	12	9	OSGR	2.0
WILSON PART NUMBER					
91-25-1048	10465438	12	9	OSGR	2.0

Lucas 10461623



Part Number	Reman Number	Volts	Pinion Teeth	Type	Kw
DELCO REMY REMANUFACTURED PART NUMBER					
10461623	10461623	12	10	DD	NA
LUCAS O.E. NUMBER					
26211A	10461623	12	10	DD	NA
DIXIE PART NUMBER					
TS-4014	10461623	12	10	DD	NA

Part Number	Reman Number	Volts	Pinion Teeth	Type	Kw
LESTER PART NUMBER					
16608	10461623	12	10	DD	NA
WILSON PART NUMBER					
91-17-8861	10461623	12	10	DD	NA

Lucas 10461631



Part Number	Reman Number	Volts	Pinion Teeth	Type	Kw
DELCO REMY REMANUFACTURED PART NUMBER					
10461631	10461631	12	11	DD	NA
LUCAS O.E. NUMBERS					
26167	10461631	12	11	DD	NA
26278	10461631	12	11	DD	NA
26278A	10461631	12	11	DD	NA
26278H	10461631	12	11	DD	NA
27413	10461631	12	11	DD	NA

Part Number	Reman Number	Volts	Pinion Teeth	Type	Kw
DIXIE PART NUMBER					
TS-4018	10461631	12	11	DD	NA
LESTER PART NUMBER					
16664	10461631	12	11	DD	NA
WILSON PART NUMBER					
91-17-8864	10461631	12	11	DD	NA

REMANUFACTURED STARTERS



Lucas 10461635



Part Number	Reman Number	Volts	Pinion Teeth	Type	Kw
DELCO Remy REMANUFACTURED PART NUMBERS					
10461635	10461635	12	11	DD	NA
LUCAS O.E. NUMBERS					
26336	10461635	12	11	DD	NA
26428	10461635	12	11	DD	NA
26428A	10461635	12	11	DD	NA
26433	10461635	12	11	DD	NA
27508	10461635	12	11	DD	NA
27556	10461635	12	11	DD	NA
27575	10461635	12	11	DD	NA

Part Number	Reman Number	Volts	Pinion Teeth	Type	Kw
DIXIE PART NUMBER					
TS-4030	10461635	12	11	DD	NA
LESTER PART NUMBER					
16984	10461635	12	11	DD	NA
WILSON PART NUMBER					
91-17-8877	10461635	12	11	DD	NA

Remanufactured Starters

Mitsubishi 10461497



Part Number	Reman Number	Volts	Pinion Teeth	Type	Kw
DELCO Remy REMANUFACTURED PART NUMBER					
10461497	10461497	12	12	PLGR	3.6
MITSUBISHI O.E. NUMBER					
M8T50171	10461497	12	12	PLGR	3.6
DIXIE PART NUMBER					
S-8727	10461497	12	12	PLGR	3.6

Part Number	Reman Number	Volts	Pinion Teeth	Type	Kw
FORD PART NUMBERS					
F4PU1100AA	10461497	12	12	PLGR	3.6
F4TZ11002B	10461497	12	12	PLGR	3.6
LESTER PART NUMBER					
17577	10461497	12	12	PLGR	3.6

Mitsubishi 10461498



Part Number	Reman Number	Volts	Pinion Teeth	Type	Kw
DELCO REMY REMANUFACTURED PART NUMBER					
10461498	10461498	12	12	PLGR	3.6
MITSUBISHI O.E. NUMBER					
M8T50071	10461498	12	12	PLGR	3.6
DIXIE PART NUMBER					
S-8423	10461498	12	12	PLGR	3.6

Part Number	Reman Number	Volts	Pinion Teeth	Type	Kw
FORD PART NUMBERS					
F4TZ11002A	10461498	12	12	PLGR	3.6
F5TU11000AA	10461498	12	12	PLGR	3.6
F5TU11000AB	10461498	12	12	PLGR	3.6
F5TU11000AD	10461498	12	12	PLGR	3.6
LESTER PART NUMBER					
17578	10461498	12	12	PLGR	3.6

Mitsubishi 10461608



Part Number	Reman Number	Volts	Pinion Teeth	Type	Kw
DELCO REMY REMANUFACTURED PART NUMBER					
10461608	10461608	12	10	OSGR	2.0
MITSUBISHI O.E. NUMBERS					
M2T56181	10461608	12	10	OSGR	2.0
M2T56182	10461608	12	10	OSGR	2.0

Part Number	Reman Number	Volts	Pinion Teeth	Type	Kw
MITSUBISHI O.E. NUMBERS (CONT.)					
M2T57271	10461608	12	10	OSGR	2.0
M2T57771	10461608	12	10	OSGR	2.0
LESTER PART NUMBER					
16853	10461608	12	10	OSGR	2.0

Mitsubishi 10461614



Part Number	Reman Number	Volts	Pinion Teeth	Type	Kw
DELCO REMY REMANUFACTURED PART NUMBER					
10461614	10461614	12	13	OSGR	2.2
MITSUBISHI O.E. NUMBERS					
M2T60171	10461614	12	13	OSGR	2.2
MD072654	10461614	12	13	OSGR	2.2

Part Number	Reman Number	Volts	Pinion Teeth	Type	Kw
DIXIE PART NUMBER					
S-8143	10461614	12	13	OSGR	2.2
LESTER PART NUMBER					
16854	10461614	12	13	OSGR	2.2

REMANUFACTURED STARTERS



Mitsubishi 10461632



Part Number	Reman Number	Volts	Pinion Teeth	Type	Kw
DELCO REMY REMANUFACTURED PART NUMBER					
10461632	10461632	12	8	DD	0.8
MITSUBISHI O.E. NUMBERS					
M3T21281	10461632	12	8	DD	0.8
M3T21282	10461632	12	8	DD	0.8
M2T21781	10461632	12	8	DD	0.8
M2T21881	10461632	12	8	DD	0.8
M3T21781D	10461632	12	8	DD	0.8
M3T21882	10461632	12	8	DD	0.8
M3T21882A	10461632	12	8	DD	0.8

Part Number	Reman Number	Volts	Pinion Teeth	Type	Kw
MITSUBISHI O.E. NUMBERS (CONT.)					
M3T38581	10461632	12	8	DD	0.8
M3T38682	10461632	12	8	DD	0.8
DIXIE PART NUMBER					
S-8153	10461632	12	8	DD	0.8
LESTER PART NUMBER					
16794	10461632	12	8	DD	0.8
WILSON PART NUMBER					
91-27-3000	10461632	12	8	DD	0.8

Mitsubishi 10461633



Part Number	Reman Number	Volts	Pinion Teeth	Type	Kw
DELCO REMY REMANUFACTURED PART NUMBER					
10461633	10461633	12	11	DD	0.8
MITSUBISHI O.E. NUMBERS					
M3T10473	10461633	12	11	DD	0.8
M3T10475	10461633	12	11	DD	0.8
M3T10476	10461633	12	11	DD	0.8
M3T10476D	10461633	12	11	DD	0.8

Part Number	Reman Number	Volts	Pinion Teeth	Type	Kw
DIXIE PART NUMBER					
S-8154	10461633	12	11	DD	0.8
LESTER PART NUMBER					
16795	10461633	12	11	DD	0.8
WILSON PART NUMBER					
91-27-3045	10461633	12	11	DD	0.8

Mitsubishi 10461641

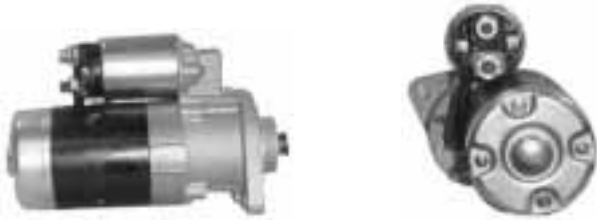

Part Number	Reman Number	Volts	Pinion Teeth	Type	Kw
-------------	--------------	-------	--------------	------	----

DELCO REMY REMANUFACTURED PART NUMBER

10461641	10461641	12	11	OSGR	1.2
----------	-----------------	----	----	------	-----

MITSUBISHI O.E. NUMBERS

M2T58581	10461641	12	11	OSGR	1.2
M2T58881	10461641	12	11	OSGR	1.2
MD171228	10461641	12	11	OSGR	1.2

Part Number	Reman Number	Volts	Pinion Teeth	Type	Kw
-------------	--------------	-------	--------------	------	----

DIXIE PART NUMBER

S-8325	10461641	12	11	OSGR	1.2
--------	-----------------	----	----	------	-----

LESTER PART NUMBER

17110	10461641	12	11	OSGR	1.2
-------	-----------------	----	----	------	-----

WILSON PART NUMBER

91-27-3094	10461641	12	11	OSGR	1.2
------------	-----------------	----	----	------	-----

Mitsubishi 10461651



Part Number	Reman Number	Volts	Pinion Teeth	Type	Kw
-------------	--------------	-------	--------------	------	----

DELCO REMY REMANUFACTURED PART NUMBER

10461651	10461651	12	9	PMGR	1.4
----------	-----------------	----	---	------	-----

MITSUBISHI O.E. NUMBERS

M1T60081	10461651	12	9	PMGR	1.4
M1T60381	10461651	12	9	PMGR	1.4

Part Number	Reman Number	Volts	Pinion Teeth	Type	Kw
-------------	--------------	-------	--------------	------	----

DIXIE PART NUMBER

S-8396	10461651	12	9	PMGR	1.4
--------	-----------------	----	---	------	-----

LESTER PART NUMBER

17437	10461651	12	9	PMGR	1.4
-------	-----------------	----	---	------	-----

WILSON PART NUMBER

91-27-3150	10461651	12	9	PMGR	1.4
------------	-----------------	----	---	------	-----

Mitsubishi 10461686



Part Number	Reman Number	Volts	Pinion Teeth	Type	Kw
-------------	--------------	-------	--------------	------	----

DELCO REMY REMANUFACTURED PART NUMBER

10461686	10461686	12	9	PMGR	1.7
----------	-----------------	----	---	------	-----

Part Number	Reman Number	Volts	Pinion Teeth	Type	Kw
-------------	--------------	-------	--------------	------	----

MITSUBISHI O.E. NUMBER

M1T66081	10461686	12	9	PMGR	1.7
----------	-----------------	----	---	------	-----

REMANUFACTURED STARTERS



Mitsubishi 10461715



Part Number	Reman Number	Volts	Pinion Teeth	Type	Kw
-------------	--------------	-------	--------------	------	----

DELCO REMY REMANUFACTURED PART NUMBER

10461715	10461715	12	9	DD	0.8
----------	-----------------	----	---	----	-----

mitsubishi O.E. NUMBERS

M3T20681	10461715	12	9	DD	0.8
M3T10672	10461715	12	9	DD	0.8

Part Number	Reman Number	Volts	Pinion Teeth	Type	Kw
-------------	--------------	-------	--------------	------	----

DIXIE PART NUMBER

S-8023	10461715	12	9	DD	0.8
--------	-----------------	----	---	----	-----

LESTER PART NUMBER

16203	10461715	12	9	DD	0.8
-------	-----------------	----	---	----	-----

WILSON PART NUMBER

91-27-3032	10461715	12	9	DD	0.8
------------	-----------------	----	---	----	-----

Mitsubishi 10465399



Part Number	Reman Number	Volts	Pinion Teeth	Type	Kw
-------------	--------------	-------	--------------	------	----

DELCO REMY REMANUFACTURED PART NUMBER

10465399	10465399	12	13	OSGR	3.6
----------	-----------------	----	----	------	-----

mitsubishi O.E. NUMBERS

M3T90071	10465399	12	13	OSGR	3.6
M3T90072	10465399	12	13	OSGR	3.6

DIXIE PART NUMBER

S-8150	10465399	12	13	OSGR	3.6
--------	-----------------	----	----	------	-----

Part Number	Reman Number	Volts	Pinion Teeth	Type	Kw
-------------	--------------	-------	--------------	------	----

FORD PART NUMBERS

E5TF11000AA	10465399	12	13	OSGR	3.6
E5TZ11002B	10465399	12	13	OSGR	3.6
E8TF11000AA	10465399	12	13	OSGR	3.6
E8TZ11002A	10465399	12	13	OSGR	3.6
F3TU11000AA	10465399	12	13	OSGR	3.6

LESTER PART NUMBER

17037	10465399	12	13	OSGR	3.6
-------	-----------------	----	----	------	-----

Nippondenso 10461518



Part Number	Reman Number	Volts	Pinion Teeth	Type	Kw
DELCO REMY REMANUFACTURED PART NUMBER					
10461518	10461518	12	13	OSGR	3.0
NIPPONDENSO O.E. NUMBER					
128000-2470	10461518	12	13	OSGR	3.0
CHEVROLET/GMC PART NUMBER					
94052173	10461518	12	13	OSGR	3.0
DIXIE PART NUMBER					
A-8314	10461518	12	13	OSGR	3.0

Part Number	Reman Number	Volts	Pinion Teeth	Type	Kw
ISUZU PART NUMBER					
2-91255-900-0	10461518	12	13	OSGR	3.0
LESTER PART NUMBER					
17306	10461518	12	13	OSGR	3.0
WILSON PART NUMBER					
91-29-5398	10461518	12	13	OSGR	3.0

Nippondenso 10461519



Part Number	Reman Number	Volts	Pinion Teeth	Type	Kw
DELCO REMY REMANUFACTURED PART NUMBER					
10461519	10461519	12	11	OSGR	2.5
NIPPONDENSO O.E. NUMBER					
028000-8630	10461519	12	11	OSGR	2.5
CHEVROLET/GMC PART NUMBER					
94052177	10461519	12	11	OSGR	2.5

Part Number	Reman Number	Volts	Pinion Teeth	Type	Kw
DIXIE PART NUMBER					
A-8596	10461519	12	11	OSGR	2.5
ISUZU PART NUMBER					
2-91255-908-0	10461519	12	11	OSGR	2.5
LESTER PART NUMBER					
16882	10461519	12	11	OSGR	2.5

REMANUFACTURED STARTERS



Nippondenso 10461520



Part Number	Reman Number	Volts	Pinion Teeth	Type	Kw
DELCO REMY REMANUFACTURED PART NUMBER					
10461520	10461520	12	11	OSGR	3.0
NIPPONDENSO O.E. NUMBERS					
128000-0490	10461520	12	11	OSGR	3.0
128000-0491	10461520	12	11	OSGR	3.0
CHEVROLET/GMC PART NUMBER					
94052175	10461520	12	11	OSGR	3.0

Part Number	Reman Number	Volts	Pinion Teeth	Type	Kw
DIXIE PART NUMBER					
S-8252	10461520	12	11	OSGR	3.0
ISUZU PART NUMBER					
2-91255-902-0	10461520	12	11	OSGR	3.0
LESTER PART NUMBER					
16881	10461520	12	11	OSGR	3.0
WILSON PART NUMBER					
91-29-5108	10461520	12	11	OSGR	3.0

Nippondenso 10461521



Part Number	Reman Number	Volts	Pinion Teeth	Type	Kw
DELCO REMY REMANUFACTURED PART NUMBER					
10461521	10461521	12	11	OSGR	3.0
NIPPONDENSO O.E. NUMBERS					
228000-280	10461521	12	11	OSGR	3.0
228000-2800	10461521	12	11	OSGR	3.0
228000-2804	10461521	12	11	OSGR	3.0
CHEVROLET/GMC PART NUMBER					
94052837	10461521	12	11	OSGR	3.0

Part Number	Reman Number	Volts	Pinion Teeth	Type	Kw
DIXIE PART NUMBER					
S-8679	10461521	12	11	OSGR	3.0
ISUZU PART NUMBER					
2-91123-420-0	10461521	12	11	OSGR	3.0
LESTER PART NUMBER					
18136	10461521	12	11	OSGR	3.0

Nippondenso 10461527



Part Number	Reman Number	Volts	Pinion Teeth	Type	Kw
DELCO REMY REMANUFACTURED PART NUMBER					
10461527	10461527	12	11	OSGR	3.0
NIPPONDENSO O.E. NUMBER					
228000-7002	10461527	12	11	OSGR	3.0

Part Number	Reman Number	Volts	Pinion Teeth	Type	Kw
CHEVROLET/GMC PART NUMBER					
97147778	10461527	12	11	OSGR	3.0
ISUZU PART NUMBER					
8-97147-778-1	10461527	12	11	OSGR	3.0

Nippondenso 10461626



Part Number	Reman Number	Volts	Pinion Teeth	Type	Kw
DELCO REMY REMANUFACTURED PART NUMBER					
10461626	10461626	12	10	DD	4.0
NIPPONDENSO O.E. NUMBERS					
028000-3290	10461626	12	10	DD	4.0
028000-3291	10461626	12	10	DD	4.0
028000-3292	10461626	12	10	DD	4.0
128000-0770	10461626	12	10	DD	4.0
128000-0771	10461626	12	10	DD	4.0
128000-0772	10461626	12	10	DD	4.0

Part Number	Reman Number	Volts	Pinion Teeth	Type	Kw
DIXIE PART NUMBER					
S-8033	10461626	12	10	DD	4.0
LESTER PART NUMBER					
16635	10461626	12	10	DD	4.0
WILSON PART NUMBER					
91-29-5018	10461626	12	10	DD	4.0

Nippondenso 10461627



Part Number	Reman Number	Volts	Pinion Teeth	Type	Kw
DELCO REMY REMANUFACTURED PART NUMBER					
10461627	10461627	12	10	DD	4.0
NIPPONDENSO O.E. NUMBERS					
028000-3970	10461627	12	10	DD	4.0
028000-3971	10461627	12	10	DD	4.0
9702800-397	10461627	12	10	DD	4.0

Part Number	Reman Number	Volts	Pinion Teeth	Type	Kw
DIXIE PART NUMBER					
S-8081	10461627	12	10	DD	4.0
LESTER PART NUMBER					
16644	10461627	12	10	DD	4.0
WILSON PART NUMBER					
91-29-5038	10461627	12	10	DD	4.0

REMANUFACTURED STARTERS



Nippondenso 10461628



Part Number	Reman Number	Volts	Pinion Teeth	Type	Kw
DELCO REMY REMANUFACTURED PART NUMBER					
10461628	10461628	24	10	DD	7.5
NIPPONDENSO O.E. NUMBERS					
028000-5250	10461628	24	10	DD	7.5
028000-5251	10461628	24	10	DD	7.5
9702800-525	10461628	24	10	DD	7.5

Part Number	Reman Number	Volts	Pinion Teeth	Type	Kw
DIXIE PART NUMBER					
S-8086	10461628	24	10	DD	7.5
LESTER PART NUMBER					
16655	10461628	24	10	DD	7.5
WILSON PART NUMBER					
91-29-5043	10461628	24	10	DD	7.5

Nippondenso 10461630



Part Number	Reman Number	Volts	Pinion Teeth	Type	Kw
DELCO REMY REMANUFACTURED PART NUMBER					
10461630	10461630	12	13	OSGR	2.5
NIPPONDENSO O.E. NUMBERS					
028000-5880	10461630	12	13	OSGR	2.5
028000-5881	10461630	12	13	OSGR	2.5
028000-5882	10461630	12	13	OSGR	2.5
9702809-558	10461630	12	13	OSGR	2.5
9702809-588	10461630	12	13	OSGR	2.5

Part Number	Reman Number	Volts	Pinion Teeth	Type	Kw
DIXIE PART NUMBER					
S-8074	10461630	12	13	OSGR	2.5
LESTER PART NUMBER					
16658	10461630	12	13	OSGR	2.5
WILSON PART NUMBER					
91-29-5035	10461630	12	13	OSGR	2.5

Nippondenso 10461640



Part Number	Reman Number	Volts	Pinion Teeth	Type	Kw
DELCO REMY REMANUFACTURED PART NUMBER					
10461640	10461640	12	9	OSGR	1.4
NIPPONDENSO O.E. NUMBER					
128000-0050	10461640	12	9	OSGR	1.4
DIXIE PART NUMBER					
S-8489	10461640	12	9	OSGR	1.4

Part Number	Reman Number	Volts	Pinion Teeth	Type	Kw
LESTER PART NUMBER					
17098	10461640	12	9	OSGR	1.4
WILSON PART NUMBER					
91-29-5193	10461640	12	9	OSGR	1.4

Nippondenso 10461642



Part Number	Reman Number	Volts	Pinion Teeth	Type	Kw
DELCO REMY REMANUFACTURED PART NUMBER					
10461642	10461642	12	-	OSGR	3.0
NIPPONDENSO O.E. NUMBERS					
228000-5730	10461642	12	-	OSGR	3.0
228000-5731	10461642	12	-	OSGR	3.0

Part Number	Reman Number	Volts	Pinion Teeth	Type	Kw
DIXIE PART NUMBER					
S-8642	10461642	12	-	OSGR	3.0
LESTER PART NUMBER					
17199	10461642	12	-	OSGR	3.0
WILSON PART NUMBER					
91-29-5406	10461642	12	-	OSGR	3.0

Nippondenso 10461643



Part Number	Reman Number	Volts	Pinion Teeth	Type	Kw
DELCO REMY REMANUFACTURED PART NUMBER					
10461643	10461643	12	NA	OSGR	3.0
NIPPONDENSO O.E. NUMBER					
228000-5510	10461643	12	NA	OSGR	3.0
DIXIE PART NUMBER					
S-8810	10461643	12	NA	OSGR	3.0

Part Number	Reman Number	Volts	Pinion Teeth	Type	Kw
LESTER PART NUMBER					
17250	10461643	12	NA	OSGR	3.0
WILSON PART NUMBER					
91-29-5437	10461643	12	NA	OSGR	3.0

Nippondenso 10461644



Part Number	Reman Number	Volts	Pinion Teeth	Type	Kw
DELCO REMY REMANUFACTURED PART NUMBER					
10461644	10461644	12	10	OSGR	2.5
NIPPONDENSO O.E. NUMBERS					
028000-6780	10461644	12	10	OSGR	2.5
028000-6781	10461644	12	10	OSGR	2.5

Part Number	Reman Number	Volts	Pinion Teeth	Type	Kw
DIXIE PART NUMBER					
S-8097	10461644	12	10	OSGR	2.5
LESTER PART NUMBER					
17348	10461644	12	10	OSGR	2.5
WILSON PART NUMBER					
91-29-5148	10461644	12	10	OSGR	2.5

REMANUFACTURED STARTERS



Nippondenso 10461645



Part Number	Reman Number	Volts	Pinion Teeth	Type	Kw
DELCO REMY REMANUFACTURED PART NUMBER					
10461645	10461645	12	10	DD	4.0
NIPPONDENSO O.E. NUMBERS					
028000-7430	10461645	12	10	DD	4.0
028000-7431	10461645	12	10	DD	4.0
128000-4340	10461645	12	10	DD	4.0
128000-5330	10461645	12	10	DD	4.0
128000-5331	10461645	12	10	DD	4.0

Part Number	Reman Number	Volts	Pinion Teeth	Type	Kw
DIXIE PART NUMBERS					
S-8098	10461645	12	10	DD	4.0
S-8285	10461645	12	10	DD	4.0
LESTER PART NUMBER					
17353	10461645	12	10	DD	4.0
WILSON PART NUMBER					
91-29-5060	10461645	12	10	DD	4.0

Nippondenso 10461646



Part Number	Reman Number	Volts	Pinion Teeth	Type	Kw
DELCO REMY REMANUFACTURED PART NUMBER					
10461646	10461646	12	9	DD	0.8
NIPPONDENSO O.E. NUMBERS					
028000-7460	10461646	12	9	DD	0.8
028000-7461	10461646	12	9	DD	0.8
028000-7462	10461646	12	9	DD	0.8A
028000-7470	10461646	12	9	DD	0.8
028000-7471	10461646	12	9	DD	0.8
028000-9570	10461646	12	9	DD	0.8

Part Number	Reman Number	Volts	Pinion Teeth	Type	Kw
DIXIE PART NUMBERS					
S-8147	10461646	12	9	DD	0.8
LESTER PART NUMBER					
17354	10461646	12	9	DD	0.8
WILSON PART NUMBER					
91-29-5112	10461646	12	9	DD	0.8

Nippondenso 10461647



Part Number	Reman Number	Volts	Pinion Teeth	Type	Kw
DELCO REMY REMANUFACTURED PART NUMBER					
10461647	10461647	12	11	OSGR	2.5
NIPPONDENSO O.E. NUMBERS					
028000-8400	10461647	12	11	OSGR	2.5
028000-8401	10461647	12	11	OSGR	2.5
028000-8402	10461647	12	11	OSGR	2.5
028000-8403	10461647	12	11	OSGR	2.5
028000-8404	10461647	12	11	OSGR	2.5
9702800-840	10461647	12	11	OSGR	2.5

Part Number	Reman Number	Volts	Pinion Teeth	Type	Kw
DIXIE PART NUMBER					
S-8278	10461647	12	11	OSGR	2.5
LESTER PART NUMBER					
17362	10461647	12	11	OSGR	2.5
WILSON PART NUMBER					
91-29-5106	10461647	12	11	OSGR	2.5

Nippondenso 10461648



Part Number	Reman Number	Volts	Pinion Teeth	Type	Kw
DELCO REMY REMANUFACTURED PART NUMBER					
10461648	10461648	24	10	DD	7.5
NIPPONDENSO O.E. NUMBER					
128000-0480	10461648	24	10	DD	7.5
DIXIE PART NUMBER					
S-8292	10461648	24	10	DD	7.5

Part Number	Reman Number	Volts	Pinion Teeth	Type	Kw
LESTER PART NUMBER					
17371	10461648	24	10	DD	7.5
WILSON PART NUMBER					
91-29-5118	10461648	24	10	DD	7.5

Nippondenso 10461650



Part Number	Reman Number	Volts	Pinion Teeth	Type	Kw
DELCO REMY REMANUFACTURED PART NUMBER					
10461650	10461650	24	10	OSGR	5.5
NIPPONDENSO O.E. NUMBERS					
128000-2560	10461650	24	10	OSGR	5.5
128000-2561	10461650	24	10	OSGR	5.5
128000-2562	10461650	24	10	OSGR	5.5
128000-2563	10461650	24	10	OSGR	5.5

Part Number	Reman Number	Volts	Pinion Teeth	Type	Kw
DIXIE PART NUMBER					
S-8283	10461650	24	10	OSGR	5.5
LESTER PART NUMBER					
17391	10461650	24	10	OSGR	5.5
WILSON PART NUMBER					
91-29-5196	10461650	24	10	OSGR	5.5

REMANUFACTURED STARTERS



Nippondenso 10461652



Part Number	Reman Number	Volts	Pinion Teeth	Type	Kw
DELCO REMY REMANUFACTURED PART NUMBER					
10461652	10461652	12	10	OSGR	2.7
NIPPONDENSO O.E. NUMBER					
228000-5210	10461652	12	10	OSGR	2.7
DIXIE PART NUMBER					
S-8500	10461652	12	10	OSGR	2.7

Part Number	Reman Number	Volts	Pinion Teeth	Type	Kw
LESTER PART NUMBER					
17458	10461652	12	10	OSGR	2.7
WILSON PART NUMBER					
91-29-5129	10461652	12	10	OSGR	2.7

Nippondenso 10461653



Part Number	Reman Number	Volts	Pinion Teeth	Type	Kw
DELCO REMY REMANUFACTURED PART NUMBER					
10461653	10461653	12	11	OSGR	2.7
NIPPONDENSO O.E. NUMBERS					
228000-581	10461653	12	11	OSGR	2.7
228000-5810	10461653	12	11	OSGR	2.7
228000-5811	10461653	12	11	OSGR	2.7

Part Number	Reman Number	Volts	Pinion Teeth	Type	Kw
DIXIE PART NUMBER					
S-8650	10461653	12	11	OSGR	2.7
LESTER PART NUMBER					
17462	10461653	12	11	OSGR	2.7
WILSON PART NUMBER					
91-29-5382	10461653	12	11	OSGR	2.7

Nippondenso 10461654



Part Number	Reman Number	Volts	Pinion Teeth	Type	Kw
DELCO REMY REMANUFACTURED PART NUMBER					
10461654	10461654	12	10	OSGR	1.4
NIPPONDENSO O.E. NUMBER					
128000-5590	10461654	12	10	OSGR	1.4
DIXIE PART NUMBER					
S-8304	10461654	12	10	OSGR	1.4

Part Number	Reman Number	Volts	Pinion Teeth	Type	Kw
LESTER PART NUMBER					
17612	10461654	12	10	OSGR	1.4
WILSON PART NUMBER					
91-29-5194	10461654	12	10	OSGR	1.4

Nippondenso 10461655



Part Number	Reman Number	Volts	Pinion Teeth	Type	Kw
DELCO REMY REMANUFACTURED PART NUMBER					
10461655	10461655	12	10	OSGR	2.5
NIPPONDENSO O.E. NUMBERS					
128000-5600	10461655	12	10	OSGR	2.5
128000-5601	10461655	12	10	OSGR	2.5
DIXIE PART NUMBER					
S-8305	10461655	12	10	OSGR	2.5

Part Number	Reman Number	Volts	Pinion Teeth	Type	Kw
LESTER PART NUMBER					
17613	10461655	12	10	OSGR	2.5
WILSON PART NUMBER					
91-29-5195	10461655	12	10	OSGR	2.5

Nippondenso 10461656



Part Number	Reman Number	Volts	Pinion Teeth	Type	Kw
DELCO REMY REMANUFACTURED PART NUMBER					
10461656	10461656	12	10	DD	4.0
NIPPONDENSO O.E. NUMBERS					
128000-5970	10461656	12	10	DD	4.0
128000-5971	10461656	12	10	DD	4.0
128000-5972	10461656	12	10	DD	4.0
128000-5973	10461656	12	10	DD	4.0
228000-2360	10461656	12	10	DD	4.0
228000-4600	10461656	12	10	DD	4.0
228000-4601	10461656	12	10	DD	4.0

Part Number	Reman Number	Volts	Pinion Teeth	Type	Kw
DIXIE PART NUMBER					
S-8294	10461656	12	10	DD	4.0
LESTER PART NUMBER					
17618	10461656	12	10	DD	4.0
WILSON PART NUMBER					
91-29-5168	10461656	12	10	DD	4.0

Nippondenso 10461657

NO PICTURE AVAILABLE

Part Number	Reman Number	Volts	Pinion Teeth	Type	Kw
DELCO REMY REMANUFACTURED PART NUMBER					
10461657	10461657	24	10	DD	7.5
NIPPONDENSO O.E. NUMBER					
128000-7240	10461657	24	10	DD	7.5
DIXIE PART NUMBER					
S-8470	10461657	24	10	DD	7.5

Part Number	Reman Number	Volts	Pinion Teeth	Type	Kw
LESTER PART NUMBER					
17626	10461657	24	10	DD	7.5
WILSON PART NUMBER					
91-29-5169	10461657	24	10	DD	7.5

REMANUFACTURED STARTERS



Nippondenso 10461658



Part Number	Reman Number	Volts	Pinion Teeth	Type	Kw
-------------	--------------	-------	--------------	------	----

DELCO REMY REMANUFACTURED PART NUMBER

10461658	10461658	12	10	DD	4.0
----------	-----------------	----	----	----	-----

NIPPONDENSO O.E. NUMBERS

228000-237	10461658	12	10	DD	4.0
228000-2370	10461658	12	10	DD	4.0

Part Number	Reman Number	Volts	Pinion Teeth	Type	Kw
-------------	--------------	-------	--------------	------	----

DIXIE PART NUMBER

S-8505	10461658	12	10	DD	4.0
--------	-----------------	----	----	----	-----

LESTER PART NUMBER

18008	10461658	12	10	DD	4.0
-------	-----------------	----	----	----	-----

WILSON PART NUMBER

91-29-5361	10461658	12	10	DD	4.0
------------	-----------------	----	----	----	-----

Nippondenso 10461683



Part Number	Reman Number	Volts	Pinion Teeth	Type	Kw
-------------	--------------	-------	--------------	------	----

DELCO REMY REMANUFACTURED PART NUMBER

10461683	10461683	12	9	OSGR	1.4
----------	-----------------	----	---	------	-----

NIPPONDENSO O.E. NUMBERS

028000-9270	10461683	12	9	OSGR	1.4
128000-0620	10461683	12	9	OSGR	1.4
128000-0622	10461683	12	9	OSGR	1.4
128000-1250	10461683	12	9	OSGR	1.4
128000-1251	10461683	12	9	OSGR	1.4

Part Number	Reman Number	Volts	Pinion Teeth	Type	Kw
-------------	--------------	-------	--------------	------	----

DIXIE PART NUMBER

S-8192	10461683	12	9	OSGR	1.4
--------	-----------------	----	---	------	-----

LESTER PART NUMBER

16790	10461683	12	9	OSGR	1.4
-------	-----------------	----	---	------	-----

WILSON PART NUMBER

91-29-5064	10461683	12	9	OSGR	1.4
------------	-----------------	----	---	------	-----

Nippondenso 10461684



Part Number	Reman Number	Volts	Pinion Teeth	Type	Kw
-------------	--------------	-------	--------------	------	----

DELCO REMY REMANUFACTURED PART NUMBER

10461684	10461684	12	-	DD	1.4
----------	-----------------	----	---	----	-----

Part Number	Reman Number	Volts	Pinion Teeth	Type	Kw
-------------	--------------	-------	--------------	------	----

NIPPONDENSO O.E. NUMBER

128000-4390	10461684	12	-	DD	1.4
-------------	-----------------	----	---	----	-----

Nippondenso 10461685



Part Number	Reman Number	Volts	Pinion Teeth	Type	Kw
DELCO REMY REMANUFACTURED PART NUMBER					
10461685	10461685	12	10	OSGR	4.0
NIPPONDENSO O.E. NUMBER					
228000-8510	10461685	12	10	OSGR	4.0

Part Number	Reman Number	Volts	Pinion Teeth	Type	Kw
WILSON PART NUMBER					
91-29-5449	10461685	12	10	OSGR	4.0

Nippondenso 10461714



Part Number	Reman Number	Volts	Pinion Teeth	Type	Kw
DELCO REMY REMANUFACTURED PART NUMBER					
10461714	10461714	12	9	OSGR	0.8
NIPPONDENSO O.E. NUMBERS					
028000-1730	10461714	12	9	OSGR	0.8
028000-1740	10461714	12	9	OSGR	0.8
028000-2000	10461714	12	9	OSGR	0.8
028000-2001	10461714	12	9	OSGR	0.8

Part Number	Reman Number	Volts	Pinion Teeth	Type	Kw
NIPPONDENSO O.E. NUMBERS (CONT.)					
028000-4270	10461714	12	9	OSGR	0.8
DIXIE PART NUMBER					
S-8018	10461714	12	9	OSGR	0.8
LESTER PART NUMBER					
16218	10461714	12	9	OSGR	0.8

REMANUFACTURED STARTERS



Nippondenso 10465440



Part Number	Reman Number	Volts	Pinion Teeth	Type	Kw
DELCO REMY REMANUFACTURED PART NUMBER					
10465440	10465440	12	15	OSGR	1.4
NIPPONDENSO O.E. NUMBERS					
0128000-0710	10465440	12	15	OSGR	1.4
0128000-5730	10465440	12	15	OSGR	1.4
128000-0710	10465440	12	15	OSGR	1.4
AC DELCO PART NUMBER					
323-971	10465440	12	15	OSGR	1.4
CARRIER PART NUMBER					
20-45-1312	10465440	12	15	OSGR	1.4

Part Number	Reman Number	Volts	Pinion Teeth	Type	Kw
CUMMINS RECON PART NUMBER					
3675205RX	10465440	12	15	OSGR	1.4
DIXIE PART NUMBERS					
S-8089	10465440	12	15	OSGR	1.4
S-8788	10465440	12	15	OSGR	1.4
LESTER PART NUMBER					
16657	10465440	12	15	OSGR	1.4
THERMO KING PART NUMBERS					
45-1312	10465440	12	15	OSGR	1.4
45-1748	10465440	12	15	OSGR	1.4
WILSON PART NUMBERS					
91-29-5042	10465440	12	15	OSGR	1.4
91-29-5202	10465440	12	15	OSGR	1.4

Remanufactured Starters

Nippondenso 10465442



Part Number	Reman Number	Volts	Pinion Teeth	Type	Kw
DELCO REMY REMANUFACTURED PART NUMBER					
10465442	10465442	12	9	OSGR	2.0
NIPPONDENSO O.E. NUMBERS					
028000-6440	10465442	12	9	OSGR	2.0
028000-7790	10465442	12	9	OSGR	2.0
028000-7791	10465442	12	9	OSGR	2.0
128000-0020	10465442	12	9	OSGR	2.0
128000-0960	10465442	12	9	OSGR	2.0
128000-2880	10465442	12	9	OSGR	2.0
128000-2881	10465442	12	9	OSGR	2.0
AC DELCO PART NUMBER					
323-972	10465442	12	9	OSGR	2.0

Part Number	Reman Number	Volts	Pinion Teeth	Type	Kw
CUMMINS RECON PART NUMBER					
3675152RX	10465442	12	9	OSGR	2.0
DIXIE PART NUMBER					
S-8152	10465442	12	9	OSGR	2.0
LESTER PART NUMBER					
16739	10465442	12	9	OSGR	2.0
MIDLAND PART NUMBERS					
RS312700X	10465442	12	9	OSGR	2.0
RS312800X	10465442	12	9	OSGR	2.0
THERMO KING PART NUMBERS					
45-1229	10465442	12	9	OSGR	2.0
45-5657	10465442	12	9	OSGR	2.0
45-5674	10465442	12	9	OSGR	2.0

Nippondenso 10465444



Part Number	Reman Number	Volts	Pinion Teeth	Type	Kw
DELCO REMY REMANUFACTURED PART NUMBER					
10465444	10465444	12	15	GR	1.4
NIPPONDENSO O.E. NUMBERS					
128000-0720	10465444	12	15	GR	1.4
128000-0721	10465444	12	15	GR	1.4
AC DELCO PART NUMBER					
323-973	10465444	12	15	GR	1.4
CARRIER PART NUMBER					
20-045-1251	10465444	12	15	GR	1.4
CUMMINS RECON PART NUMBER					
3675150RX	10465444	12	15	GR	1.4

Part Number	Reman Number	Volts	Pinion Teeth	Type	Kw
DIXIE PART NUMBER					
S-8316	10465444	12	15	GR	1.4
LESTER PART NUMBER					
17117	10465444	12	15	GR	1.4
THERMO KING PART NUMBERS					
45-904	10465444	12	15	GR	1.4
45-1251	10465444	12	15	GR	1.4
WILSON PART NUMBER					
91-29-5109	10465444	12	15	GR	1.4

Nippondenso 10465445



Part Number	Reman Number	Volts	Pinion Teeth	Type	Kw
DELCO REMY REMANUFACTURED PART NUMBER					
10465445	10465445	12	9	OSGR	2.0
NIPPONDENSO O.E. NUMBERS					
128000-2280	10465445	12	9	OSGR	2.0
128000-0570	10465445	12	9	OSGR	2.0
AC DELCO PART NUMBER					
323-974	10465445	12	9	OSGR	2.0
CARRIER PART NUMBERS					
25-39316-00	10465445	12	9	OSGR	2.0
30-00308-01	10465445	12	9	OSGR	2.0
30-00308-02	10465445	12	9	OSGR	2.0

Part Number	Reman Number	Volts	Pinion Teeth	Type	Kw
DIXIE PART NUMBER					
S-8316	10465445	12	9	OSGR	2.0
LESTER PART NUMBERS					
17373	10465445	12	9	OSGR	2.0
17375	10465445	12	9	OSGR	2.0
THERMO KING PART NUMBERS					
45-267	10465445	12	9	OSGR	2.0
45-338	10465445	12	9	OSGR	2.0
45-1170	10465445	12	9	OSGR	2.0
WILSON PART NUMBER					
91-29-5235	10465445	12	9	OSGR	2.0

REMANUFACTURED STARTERS



Nippondenso 10465528



Part Number	Reman Number	Volts	Pinion Teeth	Type	Kw
DELCO REMY REMANUFACTURED PART NUMBER					
10465528	10465528	12	13	OSGR	3
NIPPONDENSO O.E. NUMBERS					
128000-4220	10465528	12	13	OSGR	3
228000-3310	10465528	12	13	OSGR	3
228000-3311	10465528	12	13	OSGR	3
CUMMINS RECON PART NUMBER					
3604486RX	10465528	12	13	OSGR	3

Part Number	Reman Number	Volts	Pinion Teeth	Type	Kw
DIXIE PART NUMBER					
S-8275	10465528	12	13	OSGR	3
LESTER PART NUMBER					
17600	10465528	12	13	OSGR	3
WILSON PART NUMBER					
91-29-5176	10465528	12	13	OSGR	3

Remanufactured Starters

Nippondenso 10465529



Part Number	Reman Number	Volts	Pinion Teeth	Type	Kw
DELCO REMY REMANUFACTURED PART NUMBER					
10465529	10465529	12	9	OSGR	1.4
NIPPONDENSO O.E. NUMBER					
128000-4900	10465529	12	9	OSGR	1.4
CARRIER PART NUMBER					
25-35465-00	10465529	12	9	OSGR	1.4
CUMMINS RECON PART NUMBER					
675206RX	10465529	12	9	OSGR	1.4

Part Number	Reman Number	Volts	Pinion Teeth	Type	Kw
DIXIE PART NUMBER					
S-8790	10465529	12	9	OSGR	1.4
LESTER PART NUMBER					
17606	10465529	12	9	OSGR	1.4
WILSON PART NUMBER					
91-29-5147	10465529	12	9	OSGR	1.4

Nippondenso 10465530



Part Number	Reman Number	Volts	Pinion Teeth	Type	Kw
DELCO REMY REMANUFACTURED PART NUMBER					
10465530	10465530	12	13	OSGR	2.7
NIPPONDENSO O.E. NUMBERS					
228000-2290	10465530	12	13	OSGR	2.7
228000-2291	10465530	12	13	OSGR	2.7
CUMMINS RECON PART NUMBER					
3604684RX	10465530	12	13	OSGR	2.7

Part Number	Reman Number	Volts	Pinion Teeth	Type	Kw
DIXIE PART NUMBER					
S-8544	10465530	12	13	OSGR	2.7
WILSON PART NUMBER					
91-29-5245	10465530	12	13	OSGR	2.7
LESTER PART NUMBER					
17548	10465530	12	13	OSGR	2.7

Nippondenso 10465531



Part Number	Reman Number	Volts	Pinion Teeth	Type	Kw
DELCO REMY REMANUFACTURED PART NUMBER					
10465531			12	11	OSGR 1.4
NIPPONDENSO O.E. NUMBERS					
128000-0140	10465531	12	11	OSGR	1.4
128000-0141	10465531	12	11	OSGR	1.4
228000-1070	10465531	12	11	OSGR	1.4
228000-1071	10465531	12	11	OSGR	1.4 A
CARRIER PART NUMBERS					
25-37640-00	10465531	12	11	OSGR	1.4
25-37725-00	10465531	12	11	OSGR	1.4
25-38750-00	10465531	12	11	OSGR	1.4
29-39135-00	10465531	12	11	OSGR	1.4

Part Number	Reman Number	Volts	Pinion Teeth	Type	Kw
DIXIE PART NUMBER					
S-8261	10465531	12	11	OSGR	1.4
LESTER PART NUMBER					
17367	10465531	12	11	OSGR	1.4
WILSON PART NUMBER					
91-29-5107	10465531	12	11	OSGR	1.4

REMANUFACTURED STARTERS



Nippondenso 10465532



Part Number	Reman Number	Volts	Pinion Teeth	Type	Kw
DELCO REMY REMANUFACTURED PART NUMBER					
10465532	10465532	12	13	OSGR	2.5
NIPPONDENSO O.E. NUMBERS					
128000-9500	10465532	12	13	OSGR	2.5
128000-9501	10465532	12	13	OSGR	2.5
DIXIE PART NUMBER					
S-8299	10465532	12	13	OSGR	2.5

Part Number	Reman Number	Volts	Pinion Teeth	Type	Kw
LESTER PART NUMBER					
16990	10465532	12	13	OSGR	2.5
WILSON PART NUMBER					
91-29-5138	10465532	12	13	OSGR	2.5

Nippondenso 10465533



Part Number	Reman Number	Volts	Pinion Teeth	Type	Kw
DELCO REMY REMANUFACTURED PART NUMBER					
10465533	10465533	12	13	OSGR	2.7
NIPPONDENSO O.E. NUMBERS					
228000-195	10465533	12	13	OSGR	2.7
228000-1950	10465533	12	13	OSGR	2.7
228000-1951	10465533	12	13	OSGR	2.7
228000-1952	10465533	12	13	OSGR	2.7
228000-1953	10465533	12	13	OSGR	2.7

Part Number	Reman Number	Volts	Pinion Teeth	Type	Kw
DIXIE PART NUMBER					
S-8299	10465533	12	13	OSGR	2.7
LESTER PART NUMBER					
16990	10465533	12	13	OSGR	2.7
WILSON PART NUMBER					
91-29-5138	10465533	12	13	OSGR	2.7

Nippondenso 10465534



Part Number	Reman Number	Volts	Pinion Teeth	Type	Kw
DELCO REMY REMANUFACTURED PART NUMBER					
10465534	10465534	24	10	OSGR	4.5
NIPPONDENSO O.E. NUMBERS					
228000-0630	10465534	24	10	OSGR	4.5
228000-0631	10465534	24	10	OSGR	4.5
228000-1750	10465534	24	10	OSGR	4.5
228000-1751	10465534	24	10	OSGR	4.5
228000-6670	10465534	24	10	OSGR	4.5

Part Number	Reman Number	Volts	Pinion Teeth	Type	Kw
CUMMINS RECON PART NUMBER					
3675248RX	10465534	24	10	OSGR	4.5
DIXIE PART NUMBER					
S-8543	10465534	24	10	OSGR	4.5
WILSON PART NUMBER					
91-29-5368	10465534	24	10	OSGR	4.5

Nippondenso 10465535



Part Number	Reman Number	Volts	Pinion Teeth	Type	Kw
DELCO REMY REMANUFACTURED PART NUMBER					
10465535	10465535	12	13	OSGR	2.7
NIPPONDENSO O.E. NUMBER					
128000-4910	10465535	12	13	OSGR	2.7
DIXIE PART NUMBER					
S-8244	10465535	12	13	OSGR	2.7

Part Number	Reman Number	Volts	Pinion Teeth	Type	Kw
LESTER PART NUMBER					
17215	10465535	12	13	OSGR	2.7
WILSON PART NUMBER					
91-29-5141	10465535	12	13	OSGR	2.7

Nippondenso 10465536



Part Number	Reman Number	Volts	Pinion Teeth	Type	Kw
DELCO REMY REMANUFACTURED PART NUMBER					
10465536	10465536	24	10	OSGR	5.5
NIPPONDENSO O.E. NUMBERS					
228000-5000	10465536	24	10	OSGR	5.5
228000-5001	10465536	24	10	OSGR	5.5
228000-5050	10465536	24	10	OSGR	5.5

Part Number	Reman Number	Volts	Pinion Teeth	Type	Kw
DIXIE PART NUMBER					
S-8643	10465536	24	10	OSGR	5.5
WILSON PART NUMBER					
91-29-5425	10465536	24	10	OSGR	5.5

Nippondenso 10465537



Part Number	Reman Number	Volts	Pinion Teeth	Type	Kw
DELCO REMY REMANUFACTURED PART NUMBER					
10465537	10465537	12	10	OSGR	4.0
NIPPONDENSO O.E. NUMBER					
228000-5620	10465537	12	10	OSGR	4.0

Part Number	Reman Number	Volts	Pinion Teeth	Type	Kw
CUMMINS RECON PART NUMBER					
3675245RX	10465537	12	10	OSGR	4.0

REMANUFACTURED STARTERS



Nippondenso 10465538



Part Number	Reman Number	Volts	Pinion Teeth	Type	Kw
-------------	--------------	-------	--------------	------	----

DELCO REMY REMANUFACTURED PART NUMBER

10465538	10465538	24	10	OSGR	7.5
----------	-----------------	----	----	------	-----

NIPPONDENSO O.E. NUMBER

228000-5630	10465538	24	10	OSGR	7.5
-------------	-----------------	----	----	------	-----

Part Number	Reman Number	Volts	Pinion Teeth	Type	Kw
-------------	--------------	-------	--------------	------	----

CUMMINS RECON PART NUMBER

3675247RX	10465538	24	10	OSGR	7.5
-----------	-----------------	----	----	------	-----

Nippondenso 10465539



Part Number	Reman Number	Volts	Pinion Teeth	Type	Kw
-------------	--------------	-------	--------------	------	----

DELCO REMY REMANUFACTURED PART NUMBER

10465539	10465539	12	10	OSGR	4.8
----------	-----------------	----	----	------	-----

NIPPONDENSO O.E. NUMBER

228000-5900	10465539	12	10	OSGR	4.8
-------------	-----------------	----	----	------	-----

Part Number	Reman Number	Volts	Pinion Teeth	Type	Kw
-------------	--------------	-------	--------------	------	----

CUMMINS RECON PART NUMBER

3675246RX	10465539	12	10	OSGR	4.8
-----------	-----------------	----	----	------	-----

WILSON PART NUMBER

90-29-5426	10465539	12	10	OSGR	4.8
------------	-----------------	----	----	------	-----

Nippondenso 10465540



Part Number	Reman Number	Volts	Pinion Teeth	Type	Kw
-------------	--------------	-------	--------------	------	----

DELCO REMY REMANUFACTURED PART NUMBER

10465540	10465540	12	13	OSGR	2.5
----------	-----------------	----	----	------	-----

NIPPONDENSO O.E. NUMBERS

128000-0210	10465540	12	13	OSGR	2.5
128000-0211	10465540	12	13	OSGR	2.5
128000-0212	10465540	12	13	OSGR	2.5
128000-0213	10465540	12	13	OSGR	2.5
128000-0540	10465540	12	13	OSGR	2.5
128000-0541	10465540	12	13	OSGR	2.5
128000-0542	10465540	12	13	OSGR	2.5
128000-0543	10465540	12	13	OSGR	2.5
128000-2270	10465540	12	13	OSGR	2.5

Part Number	Reman Number	Volts	Pinion Teeth	Type	Kw
-------------	--------------	-------	--------------	------	----

CUMMINS RECON PART NUMBERS

3604485RX	10465540	12	13	OSGR	2.5
3604660RX	10465540	12	13	OSGR	2.5
3675154RX	10465540	12	13	OSGR	2.5

DIXIE PART NUMBER

S-8254	10465540	12	13	OSGR	2.5
--------	-----------------	----	----	------	-----

WILSON PART NUMBER

91-29-5138	10465540	12	13	OSGR	2.5
------------	-----------------	----	----	------	-----

Nippondenso 10465541



Part Number	Reman Number	Volts	Pinion Teeth	Type	Kw
DELCO REMY REMANUFACTURED PART NUMBER					
10465541	10465541	12	13	OSGR	3.0
NIPPONDENSO O.E. NUMBERS					
228000-2670	10465541	12	13	OSGR	3.0
228000-3320	10465541	12	13	OSGR	3.0
228000-3321	10465541	12	13	OSGR	3.0

Part Number	Reman Number	Volts	Pinion Teeth	Type	Kw
CUMMINS RECON PART NUMBER					
3675155RX	10465541	12	13	OSGR	3.0
DIXIE PART NUMBER					
S-8275	10465541	12	13	OSGR	3.0
WILSON PART NUMBER					
91-29-5176	10465541	12	13	OSGR	3.0

Nippondenso 10465584



Part Number	Reman Number	Volts	Pinion Teeth	Type	Kw
DELCO REMY REMANUFACTURED PART NUMBER					
10465584	10465584	12	15	OSGR	1.0
NIPPONDENSO O.E. NUMBER					
128000-0740	10465584	12	15	OSGR	1.0
DIXIE PART NUMBER					
S-8124	10465584	12	15	OSGR	1.0

Part Number	Reman Number	Volts	Pinion Teeth	Type	Kw
LESTER PART NUMBER					
17375	10465584	12	15	OSGR	1.0
THERMO KING PART NUMBER					
45-1335	10465584	12	15	OSGR	1.0
WILSON PART NUMBER					
91-29-5140	10465584	12	15	OSGR	1.0

Prestolite 10461680



Part Number	Reman Number	Volts	Pinion Teeth	Type	Kw
DELCO REMY REMANUFACTURED PART NUMBER					
10461680	10461680	12	9	DD	NA
PRESTOLITE O.E. NUMBERS					
MDU-7102	10461680	12	9	DD	NA
MDU-7102A	10461680	12	9	DD	NA

Part Number	Reman Number	Volts	Pinion Teeth	Type	Kw
DIXIE PART NUMBER					
TS-5007	10461680	12	9	DD	NA
LESTER PART NUMBER					
5246	10461680	12	9	DD	NA
WILSON PART NUMBER					
91-06-1925	10461680	12	9	DD	NA

REMANUFACTURED STARTERS



Prestolite 10461681



Part Number	Reman Number	Volts	Pinion Teeth	Type	Kw
DELCO REMY REMANUFACTURED PART NUMBER					
10461681	10461681	12	9	DD	NA
PRESTOLITE O.E. NUMBERS					
MDU-7104	10461681	12	9	DD	NA
MDU-7104A	10461681	12	9	DD	NA
DIXIE PART NUMBER					
TS-5007	10461681	12	9	DD	NA

Part Number	Reman Number	Volts	Pinion Teeth	Type	Kw
LESTER PART NUMBER					
5246	10461681	12	9	DD	NA
WILSON PART NUMBER					
91-06-1925	10461681	12	9	DD	NA

Prestolite 10461682



Part Number	Reman Number	Volts	Pinion Teeth	Type	Kw
DELCO REMY REMANUFACTURED PART NUMBER					
10461682	10461682	12	9	DD	NA
PRESTOLITE O.E. NUMBERS					
MDU-7115	10461682	12	9	DD	NA
MDU-7115A	10461682	12	9	DD	NA
DIXIE PART NUMBER					
TS-5069	10461682	12	9	DD	NA

Part Number	Reman Number	Volts	Pinion Teeth	Type	Kw
LESTER PART NUMBER					
5750	10461682	12	9	DD	NA
WILSON PART NUMBER					
91-06-1891	10461682	12	9	DD	NA

Prestolite 10461709



Part Number	Reman Number	Volts	Pinion Teeth	Type	Kw
DELCO REMY REMANUFACTURED PART NUMBER					
10461709	10461709	12	9	DD	-
PRESTOLITE O.E. PART NUMBERS					
MDT6013	10461709	12	9	DD	-
MDT6013A	10461709	12	9	DD	-
MDT6021	10461709	12	9	DD	-
MDT6021	10461709	12	9	DD	-

Part Number	Reman Number	Volts	Pinion Teeth	Type	Kw
DIXIE PART NUMBER					
TS-5058	10461709	12	9	DD	-
LESTER PART NUMBER					
5613	10461709	12	9	DD	-
WILSON PART NUMBER					
91-06-1881	10461709	12	9	DD	-

Prestolite 10461710



Part Number	Reman Number	Volts	Pinion Teeth	Type	Kw
-------------	--------------	-------	--------------	------	----

DELCO REMY REMANUFACTURED PART NUMBER

10461710	10461710	12	10	DD	-
----------	-----------------	----	----	----	---

PRESTOLITE O.E. PART NUMBERS

MBG4140	10461710	12	10	DD	-
MBG4141	10461710	12	10	DD	-

DIXIE PART NUMBER

TS-5068	10461710	12	10	DD	-
---------	-----------------	----	----	----	---

Part Number	Reman Number	Volts	Pinion Teeth	Type	Kw
-------------	--------------	-------	--------------	------	----

LESTER PART NUMBER

5494	10461710	12	10	DD	-
------	-----------------	----	----	----	---

WILSON PART NUMBER

91-06-1890	10461710	12	10	DD	-
------------	-----------------	----	----	----	---

Prestolite 10461711



Part Number	Reman Number	Volts	Pinion Teeth	Type	Kw
-------------	--------------	-------	--------------	------	----

DELCO REMY REMANUFACTURED PART NUMBER

10461711	10461711	6	10	DD	NA
----------	-----------------	---	----	----	----

PRESTOLITE O.E. PART NUMBERS

MZ4118	10461711	6	10	DD	NA
MZ4175	10461711	6	10	DD	NA
MZ4184	10461711	6	10	DD	NA
MZ4192	10461711	6	10	DD	NA
MZ4194	10461711	6	10	DD	NA

Part Number	Reman Number	Volts	Pinion Teeth	Type	Kw
-------------	--------------	-------	--------------	------	----

DIXIE PART NUMBER

TS-5000	10461711	6	10	DD	NA
---------	-----------------	---	----	----	----

LESTER PART NUMBER

5450	10461711	6	10	DD	NA
------	-----------------	---	----	----	----

WILSON PART NUMBER

91-06-1801	10461711	6	10	DD	NA
------------	-----------------	---	----	----	----

Prestolite 10461712



Part Number	Reman Number	Volts	Pinion Teeth	Type	Kw
-------------	--------------	-------	--------------	------	----

DELCO REMY REMANUFACTURED PART NUMBER

10461712	10461712	12	9	DD	NA
----------	-----------------	----	---	----	----

PRESTOLITE O.E. PART NUMBERS

ML4358	10461712	12	9	DD	NA
ML4376	10461712	12	9	DD	NA
ML4377	10461712	12	9	DD	NA

Part Number	Reman Number	Volts	Pinion Teeth	Type	Kw
-------------	--------------	-------	--------------	------	----

DIXIE PART NUMBER

S-2011	10461712	12	9	DD	NA
--------	-----------------	----	---	----	----

LESTER PART NUMBER

5384	10461712	12	9	DD	NA
------	-----------------	----	---	----	----

WILSON PART NUMBER

91-02-5796	10461712	12	9	DD	NA
------------	-----------------	----	---	----	----

REMANUFACTURED STARTERS



Prestolite 10461713



Part Number	Reman Number	Volts	Pinion Teeth	Type	Kw	Mtg. Hole
DELCO REMY REMANUFACTURED PART NUMBER						
10461713	10461713	12	9	DD	NA	
PRESTOLITE O.E. PART NUMBERS						
MDU6003	10461713	12	9	DD	NA	
MDU6013	10461713	12	9	DD	NA	
MDU7001	10461713	12	9	DD	NA	

Part Number	Reman Number	Volts	Pinion Teeth	Type	Kw	Mtg. Hole
DIXIE PART NUMBER						
S-5037	10461713	12	9	DD	NA	
LESTER PART NUMBER						
3460	10461713	12	9	DD	NA	
WILSON PART NUMBER						
91-06-1836	10461713	12	9	DD	NA	

Solenoid



Part Number	Reman Number	Starter Applications	Volt
DELCO REMY REMANUFACTURED PART NUMBERS			
10456390	10456390	40/50MT	12
10456391	10456391	40/50MT	24
10456392	10456392	37MT	12
10456393	10456393	42MT	12
DELCO REMY NEW SERVICE PART NUMBERS			
1115673		42MT	24
DELCO REMY O.E. PART NUMBERS			
1115502	10456390	40/50MT	12
1115544	10456391	40/50MT	24
1115548	10456391	40/50MT	24
1115556	10456390	40/50MT	12
1115557	10456391	40/50MT	24
1115559	10456391	40/50MT	24
1115593	10456393	42MT	12
1115595	1115673	42MT	24
1115609	10456392	37MT	12
1115611	10456392	37MT	12
1119832	10456391	40/50MT	24
1119835	10456390	40/50MT	12

Part Number	Reman Number	Starter Applications	Volt
DELCO REMY O.E. PART NUMBERS (CONT.)			
1119843	10456391	40/50MT	24
1119848	10456391	40/50MT	24
1119853	10456390	40/50MT	12
1119878	10456390	40/50MT	12
1945399	10456391	40/50MT	24
1969194	10456391	40/50MT	24
CHAMPION PART NUMBERS			
211	10456390	40/50MT	12
260	10456391	40/50MT	24
265	10456393	42MT	12
CUMMINS RECON PART NUMBERS			
3603869RX	10456391	40/50MT	24
3603870RX	10456390	40/50MT	12
3604230RX	10456390	40/50MT	12
3604231RX	10456391	40/50MT	24
3604649RX	10456393	42MT	12
3604651RX	10456392	37MT	12

REMANUFACTURED STARTERS

Semi-Solid Link Solenoid



*Note: rev term

Part Number	SSL Number	Starter Applications	Volt
-------------	------------	----------------------	------

DELCO REMY REMANUFACTURED PART NUMBERS

10512653	10512653	42MT	12
----------	-----------------	------	----

Part Number	SSL Number	Starter Applications	Volt
-------------	------------	----------------------	------

DELCO REMY O.E. PART NUMBERS

1115593	10512653	42MT	12
1115688	10512653	42MT	12
1115703	10512653	42MT	12
1115707	10512653	42MT	12
1115712	10512653	42MT	12
10456393	10512653	42MT	12

Remanufactured Starters

REMANUFACTURED STARTERS

Any starter motor model may have combinations of these features.

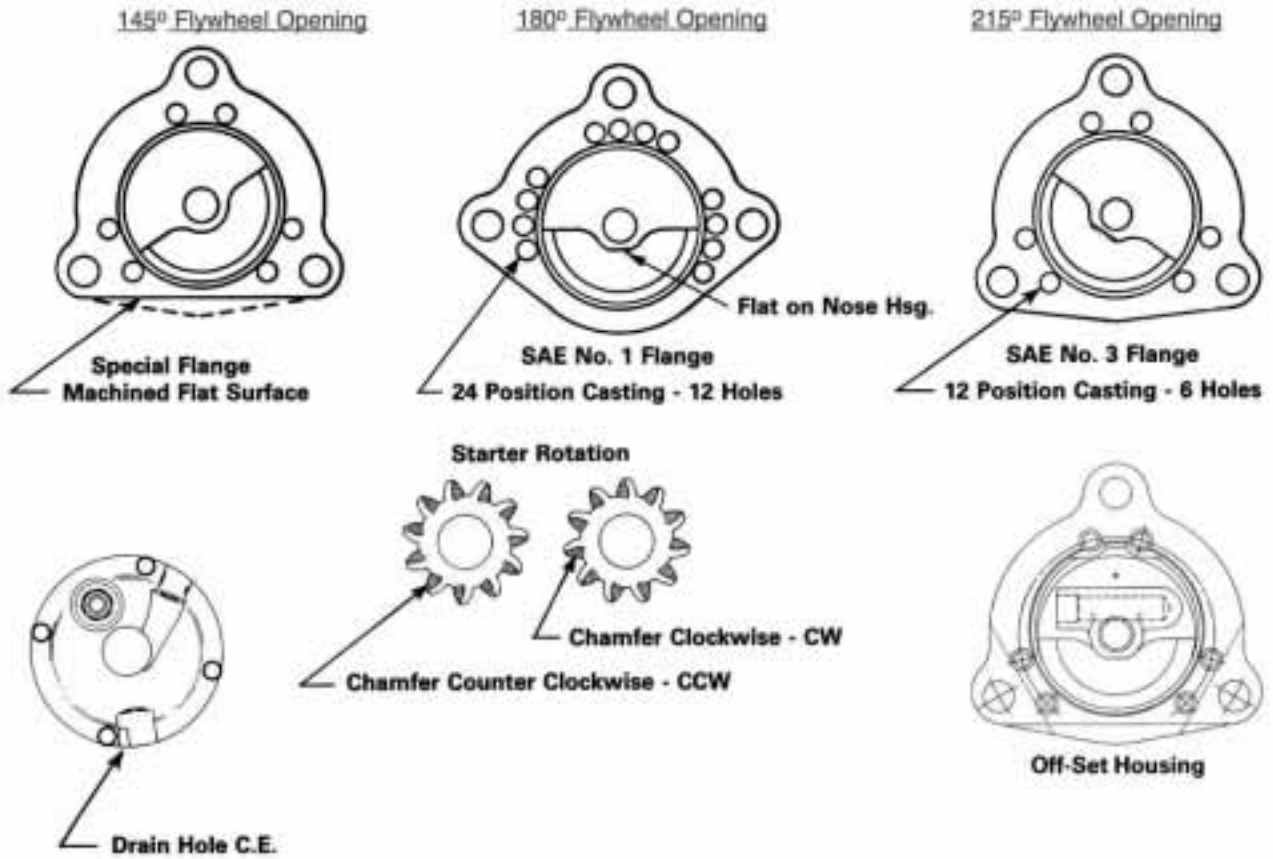

37MT, 41MT & 42 MT SERIES Solenoid Terminals Reversed

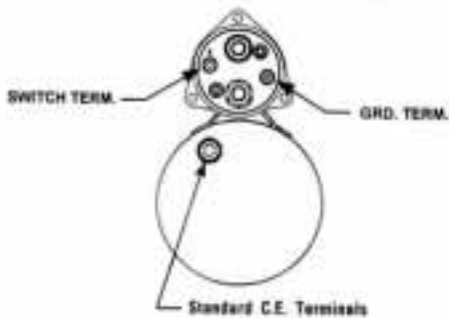

Standard Solenoid Terminals

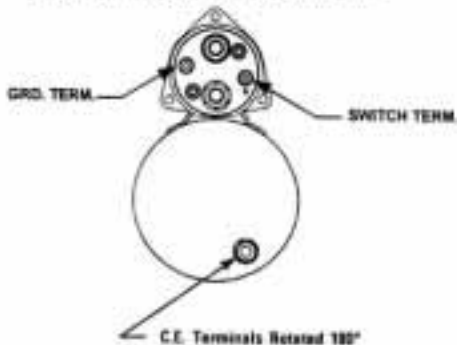

40MT & 50 MT SERIES Solenoid Terminals Reversed

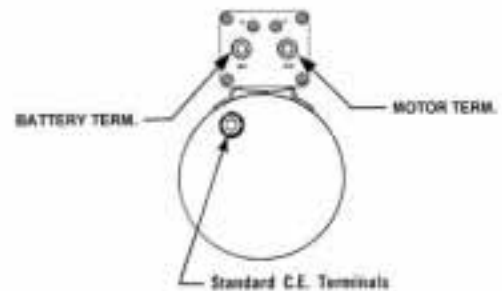

Standard Solenoid Terminals

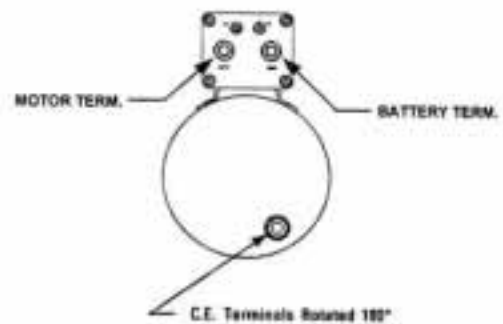

Remanufactured Starters

37, 40, 41, 42 & 50MT

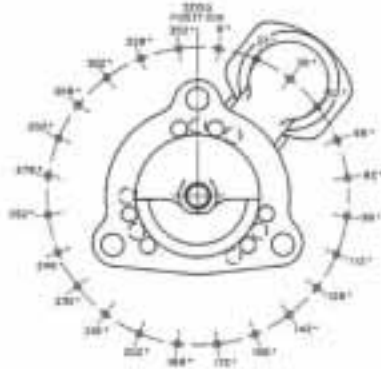

- 12 OR 24 POSITION
 12 POSITION — ENDING IN 2° OR 8°
 EVERY 30°
 24 POSITION — ENDING IN 2° AND 8°
 EVERY 15°

40MT

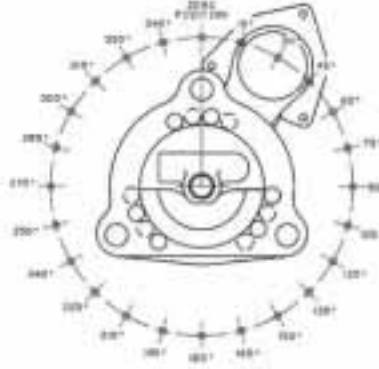

- 12 OR 24 POSITION
 12 POSITION — ENDING IN 0° OR 5°
 EVERY 30°
 24 POSITION — ENDING IN 0° AND 5°
 EVERY 15°

40 & 42 MT

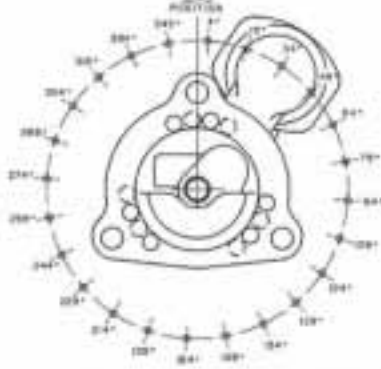

- 12 OR 24 POSITION 12 POSITION
 12 POSITION — ENDING IN 4° OR 9°
 EVERY 30°
 24 POSITION — ENDING IN 4° AND 9°
 EVERY 15°

42MT

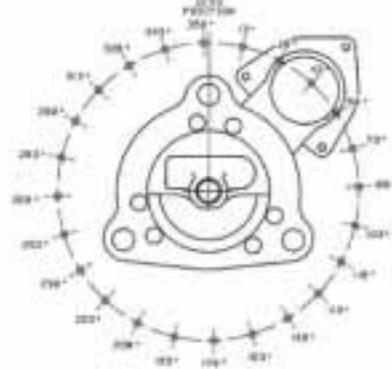

- 12 POSITION
 12 POSITION — ENDING IN 3° OR 6°
 EVERY 30°

After nose housing has been re-positioned insert starting motor to engine mounting bolt in each mounting hole to determine if 12 point head mounting bolt may be required.

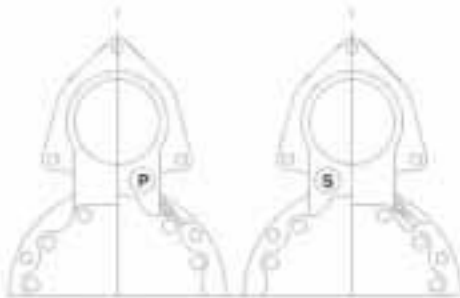

SOLENOID POSITION VIEWED FROM DRIVE END OF STARTING MOTOR.

24-position nose housings (12 holes) may use either P or S lever housings. On 12-position nose housings (6 holes: all angles ending in 2 degrees use "S" lever housing and all angles ending in 8 degrees use "P" lever housing.

POPULAR NEW SERVICE ALTERNATORS



11SI



Model	Volts	Battery Term	R Term	I Term	Amps
POPULAR NEW SERVICE PART NUMBERS					
19020207	12	M8	CONN	CONN	70
19020208	12	M8	CONN	CONN	95
19020209	24	M8	CONN	CONN	45
8600000	12	M8	CONN	CONN	95

New Service Part Number	Volts	Battery Term	R Term	I Term	Amps
POPULAR NEW SERVICE PART NUMBERS (CONT.)					
8600075	24	M8	CONN	CONN	45
8600030	12	M8	CONN	CONN	95
8600031	24	M8	CONN	CONN	45

19SI

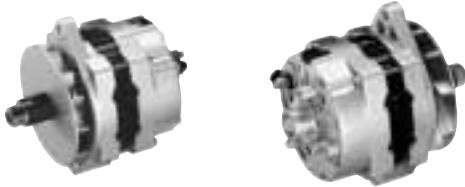

New Service Part Number	Volts	Battery Term	R Term	I Term	Amps
POPULAR NEW SERVICE PART NUMBER					
19009951	12	M6	Blade	Blade	105

21SI

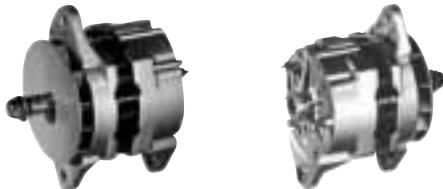

New Service Part Number	Volts	Battery Term	R Term	I Term	Amps
POPULAR NEW SERVICE PART NUMBERS					
1117965	12	5/16	#10	#10	100
19010100	12	1/4	PIN	-	100
19010105	12	5/16	#10	#10	100

New Service Part Number	Volts	Battery Term	R Term	I Term	Amps
POPULAR NEW SERVICE PART NUMBERS (CONT.)					
19010110	12	5/16	#10	-	160
19010112	12	5/16	#10	-	100
19010126	12	5/16	#10	#10	160

*Refer to Electrical Specifications and Selections Guide for additional New Service part numbers.

22SI



Part Number	New Service Part Number	Volts	Battery Term	R Term	I Term	Amps
POPULAR NEW SERVICE PART NUMBERS						
19020307	19020307	24	M6	M4	M4	70
19020308	19020308	12	1/4	#10	#10	100
19020309	19020309	12	1/4	#10	#10	130
19020310	19020310	12	1/4	#10	#10	150

CHAMPION PART NUMBER

6940	19020309	12	1/4	#10	#10	130
------	-----------------	----	-----	-----	-----	-----

CUMMINS RECON PART NUMBERS

3603858RX	19020308	12	1/4	#10	#10	100
3603859RX	19020308	12	1/4	#10	#10	100
3604234RX	19020309	12	1/4	#10	#10	130

DIXIE PART NUMBERS

A-1492	19020308	12	1/4	#10	#10	100
A-1493	19020309	12	1/4	#10	#10	130
A-1494	19020310	12	1/4	#10	#10	145

Part Number	New Service Part Number	Volts	Battery Term	R Term	I Term	Amps
LEECE NEVILLE PART NUMBER						
110555N	19020309	12	1/4	#10	#10	130

LESTER PART NUMBERS

8070	19020308	12	1/4	#10	#10	100
8073	19020309	12	1/4	#10	#10	130
8076	19020310	12	1/4	#10	#10	145

MOTOROLA/PRESTOLITE PART NUMBERS

110-250	19020308	12	1/4	#10	#10	100
110-255	19020310	12	1/4	#10	#10	145
110-255	19020309	12	1/4	#10	#10	130

WILSON PART NUMBERS

90-01-4295	19020309	12	1/4	#10	#10	130
90-01-4296	19020308	12	1/4	#10	#10	100
90-01-4297	19020310	12	1/4	#10	#10	145

22SI QuaDRAMOUNT®



New Service Part Number	Volts	Battery Term	R Term	I Term	Amps
POPULAR NEW SERVICE PART NUMBERS					
19020888	12	5/16	#10	#10	130
19020889	12	5/16	#10	#10	150

23SI

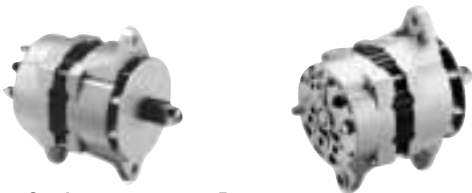

New Service Part Number	Volts	Battery Term	R Term	I Term	Amps
POPULAR NEW SERVICE PART NUMBERS					
19011009	12	1/4	PIN	#10	100
19011016	12	5/16	#10	#10	100
19011017	12	5/16	#10	#10	130

POPULAR NEW SERVICE ALTERNATORS



24SI



PAD Mount



J180

Part Number	Volts	Battery Term	Gnd Term	Mtg	Amps
POPULAR NEW SERVICE PART NUMBERS					
8600032	12	5/16	1/4	J180	100
8600043	12	5/16	1/4	PAD	160
8600067	12	5/16	1/4	J180	145
8600068	12	5/16	CONN	J180	160

Part Number	Volts	Battery Term	Gnd Term	Mtg	Amps
POPULAR NEW SERVICE PART NUMBERS (CONT.)					
19020900	12	5/16	1/4	PAD	145
19020901	12	5/16	1/4	J180	145
19020902	12	5/16	1/4	PAD	130
19020903	12	5/16	1/4	J180	130

31SI



New Service Part Number	Volts	Battery Term	R Term	I Term	Amps
POPULAR NEW SERVICE PART NUMBERS					
19011100	12	1/4	PIN	#10	160
19011101	12	1/4	#10	#10	160
19011104	12	5/16	PIN	#10	200

New Service Part Number	Volts	Battery Term	R Term	I Term	Amps
POPULAR NEW SERVICE PART NUMBERS (CONT.)					
19011105	12	5/16	#10	#10	200
19011107	12	5/16	#10	#10	160
19011108	24	1/4	#10	#10	140

33SI



New Service Part Number	Volts	Battery Term	R Term	I Term	Amps
POPULAR NEW SERVICE PART NUMBERS					
19011150	12	1/4	#10	#10	110
19011155	12	1/4	#10	#10	135
19011212	12	1/4	#10	#10	135

Popular New Service Alternators

*Refer to Electrical Specifications and Selections Guide for additional New Service part numbers.

POPULAR NEW SERVICE ALTERNATORS

34SI QUAD Mount



* remote sense

New Service Part Number	Volts	Battery Term	R Term	I Term	Amps
-------------------------	-------	--------------	--------	--------	------

POPULAR NEW SERVICE PART NUMBERS

19011157	12	1/4	#10	#10	110
19011167	12	1/4	#10	#10	135

New Service Part Number	Volts	Battery Term	R Term	I Term	Amps
-------------------------	-------	--------------	--------	--------	------

POPULAR NEW SERVICE PART NUMBERS (CONT.)

19011179*	12	1/4	#10	#10	135
19011214	12	1/4	#10	#10	135

34SI PAD Mount



* remote sense

New Service Part Number	Volts	Battery Term	R Term	I Term	Amps
-------------------------	-------	--------------	--------	--------	------

POPULAR NEW SERVICE PART NUMBERS

19011177	12	1/4	#10	#10	135
19011187*	12	1/4	#10	#10	135
19011216	12	1/4	#10	#10	135

35SI



*Note: remote sense

New Service Part Number	Volts	Battery Term	R Term	I Term	Amps
-------------------------	-------	--------------	--------	--------	------

POPULAR NEW SERVICE PART NUMBERS

19011227	12	1/4	#10	#10	110
19011228	12	1/4	PIN	#10	110
19011229	12	1/4	P/T	#10	135
19011231	12	1/4	#10	#10	110
19011232	12	1/4	#10	#10	135

New Service Part Number	Volts	Battery Term	R Term	I Term	Amps
-------------------------	-------	--------------	--------	--------	------

POPULAR NEW SERVICE PART NUMBERS (CONT.)

19011248	12	1/4	#10	#10	135
19011260	12	1/4	#10	#10	135
19011263	12	1/4	#10	#10	110
19011264	12	1/4	#10	#10	135

POPULAR NEW SERVICE ALTERNATORS



35SI QUAD Mount



*Note: remote sense

New Service Part Number	Volts	Battery Term	R Term	I Term	Amps
POPULAR NEW SERVICE PART NUMBERS					
19011234	12	1/4	#10	#10	110
19011244	12	1/4	#10	#10	135
19011246	12	1/4	#10	#10	110
19011249	12	1/4	#10	#10	135

New Service Part Number	Volts	Battery Term	R Term	I Term	Amps
POPULAR NEW SERVICE PART NUMBERS (CONT.)					
19011255	12	1/4	#10	#10	135
19011261	12	1/4	#10	#10	135
19011265	12	1/4	#10	#10	110
19011266	12	1/4	#10	#10	135

35SI PAD Mount



*Note: remote sense

New Service Part Number	Volts	Battery Term	R Term	I Term	Amps
POPULAR NEW SERVICE PART NUMBERS					
19011252	12	1/4	#10	#10	110
19011253	12	1/4	#10	#10	135
19011258	12	1/4	#10	#10	135
19011262	12	1/4	#10	#10	135

New Service Part Number	Volts	Battery Term	R Term	I Term	Amps
POPULAR NEW SERVICE PART NUMBERS (CONT.)					
19011267	12	1/4	#10	#10	110
19011268	12	1/4	#10	#10	135
19011272	12	1/4	#10	#10	110
19011273	12	1/4	#10	#10	135

35SI HP



J180 Mount



QUAD Mount



PAD Mount

New Service Part Number	Volts	Battery Term	R Term	I Term	Mtg	Amps
POPULAR NEW SERVICE PART NUMBERS						
8600064	12	1/4	#10	#10	J180	140
8600065	12	1/4	#10	#10	QUAD	140
8600066	12	1/4	#10	#10	PAD	140

Popular New Service Alternators

T1 Alternator



Part Number	New Service Part Number	Starter Applications	Volts
POPULAR NEW SERVICE PART NUMBERS			
19025330	19025330	24	140
19025331	19025331	24	140
19025333	19025333	24	140
19025335	19025335	24	120
19025336	19025336	24	120
19025337	19025337	24	140

BOSCH PART NUMBERS			
0-120-689-503	19025330	24	140
0-120-689-506	19025336	24	120
0-120-689-507	19025333	24	140
0-120-689-508	19025330	24	140
0-120-689-511	19025331	24	140
0-120-689-512	19025330	24	140
0-120-689-513	19025330	24	140
0-120-689-517	19025333	24	140
0-120-689-520	19025330	24	140
0-120-689-522	19025333	24	140
0-120-689-526	19025335	24	120
0-120-689-527	19025333	24	140
0-120-689-530	19025330	24	140

Part Number	New Service Part Number	Starter Applications	Volts
BOSCH PART NUMBERS (CONT.)			
0-120-689-533	19025330	24	140
0-120-689-535	19025330	24	140
0-120-689-540	19025333	24	140
0-120-689-541	19025333	24	140
0-120-689-542	19025333	24	140
0-120-689-545	19025330	24	140
0-120-689-546	19025333	24	140
0-120-689-548	19025331	24	140
0-120-689-552	19025337	24	140
0-120-689-566	19025337	24	140
0-120-689-567	19025333	24	140
0-120-689-571	19025330	24	140
0-986-031-600	19025330	24	140
0-986-033-520	19025330	24	140
0-986-033-550	19025330	24	140
0-986-034-610	19025331	24	140
0-986-034-910	19025330	24	140
0-986-037-420	19025330	24	140
0-986-038-290	19025330	24	140
0-986-039-140	19025335	24	120
0-986-039-530	19025333	24	140

POPULAR NEW SERVICE STARTERS



28MT



New Service Part Number	Volts	Pinion Teeth	Switch Pos.	Mtg. Hole	Nose Hsg.
POPULAR NEW SERVICE PART NUMBERS					
1113275	12	10	315	0.41	01
1113276	12	10	315	0.41	01
1113277	24	10	315	0.41	01
1113292	12	10	315	0.41	01

New Service Part Number	Volts	Pinion Teeth	Switch Pos.	Mtg. Hole	Nose Hsg.
POPULAR NEW SERVICE PART NUMBERS (CONT.)					
1113296	12	10	304	0.45	PD
10479614	12	10	120	0.41	01
10479630	12	10	316	0.48	04

29MT



New Service Part Number	Volts	Pinion Teeth	Switch Pos.	Mtg. Hole	Nose Hsg.
POPULAR NEW SERVICE PART NUMBERS					
8200010	12	10	315	.43	01
8200011	12	9	315	.43	01
8200067	12	10	055	.43	01
19011400	12	10	315	.43	01
19011402	12	10	055	.43	01

New Service Part Number	Volts	Pinion Teeth	Switch Pos.	Mtg. Hole	Nose Hsg.
POPULAR NEW SERVICE PART NUMBERS (CONT.)					
19011403	12	9	315	.43	01
19011404	12	10	055	.39	01
19011407	12	10	055	.39	01
19011409	12	10	315	.39	01

37MT



New Service Part Number	Volts	Pinion Teeth	Switch Pos.	Mtg. Hole	Nose Hsg.
POPULAR NEW SERVICE PART NUMBERS					
1993854	12	10	308	0.66	03
10478831	12	10	128	0.41	01

Popular New Service Starters

*Refer to Electrical Specifications and Selections Guide for additional New Service part numbers.

POPULAR NEW SERVICE STARTERS

38MT



Note:
† IMS - integral magnetic switch

New Service Part Number	Volts	Pinion Teeth	Switch Pos.	Mtg. Hole	Nose Hsg.	New Service Part Number	Volts	Pinion Teeth	Switch Pos.	Mtg. Hole	Nose Hsg.
POPULAR NEW SERVICE PART NUMBERS						POPULAR NEW SERVICE PART NUMBERS (CONT.)					
8200000	24	12	082	.53	03	19016031	12	10	315	.43	01
8200005	12	12	82.5	.53	03	19023060	24	12	082	.53	03
8200007	12	11	315	.43	01	19026026	24	12	082	.53	03
8200023	12	10	315	.43	01	19026027	12	10	127	.43	01
8200024	24	10	315	.43	01	19026028	12	12	082	.53	03
8200025	12	12	82.5	.53	03	19026029	12	12	082	.53	03
8200072	24	12	082	.53	03	19026032	24	10	315	.43	01
8200076	12	10	128	.43	01	19026035	12	11	315	.43	01

39MT



Note:
* overcrank protection - OCP
† IMS - integral magnetic switch

New Service Part Number	Volts	Pinion Teeth	Switch Pos.	Mtg. Hole	Nose Hsg.	New Service Part Number	Volts	Pinion Teeth	Switch Pos.	Mtg. Hole	Nose Hsg.
POPULAR NEW SERVICE PART NUMBERS						POPULAR NEW SERVICE PART NUMBERS (CONT.)					
8200027	24	12	082	.53	03	19011508	12	11	278	.66	03
8200028	12	12	307	.53	03	19011509	24	11	278	.66	03
8200029	12	11	052	.66	03	19011510	12	12	082	.53	03
8200030	12	12	82.5	.53	03	19011511	24	12	308	.53	03
8200031	12	11	278	.66	03	19011512	24	12	082	.53	03
8200032	24	11	278	.66	03	19011513	12	12	308	.53	03
8200033	12	11	082	.66	03	19011514	12	12	082	.66	03
8200034	24	11	082	.66	03	19011515	12	12	037	.53	03
8200037	12	11	052	.66	03	19011516	12	11	082	.66	03
8200038	12	11	278	.66	03	19011517	12	12	082	.53	03
8200039	24	11	278	.66	03	19011518	12	11	082	.66	03
8200040	12	11	082	.66	03	19011521	12	11	082	.66	03
8200041	24	11	082	.66	03	19011522	24	11	082	.66	03
8200042	12	12	082	.53	03	19011523	24	11	278	.66	03
8200043	24	12	308	.53	03	19011524	24	12	308	.53	03
8200044	24	12	082	.53	03	19011525	12	12	082	.53	03
8200045	12	12	308	.53	03	19011526	12	12	082	.53	03
19011500	12	11	052	.66	03	19011529	12	11	082	.66	03
19011505	12	11	052	.66	03	19011530	12	11	082	.66	03
19011506	12	11	082	.66	03	19011531	12	11	52	.66	03
19011507	24	11	082	.66	03						

POPULAR NEW SERVICE STARTERS



41MT



New Service Part Number	Volts	Pinion Teeth	Switch Pos.	Mtg. Hole	Nose Hsg.
-------------------------	-------	--------------	-------------	-----------	-----------

POPULAR NEW SERVICE PART NUMBERS

10478999	12	12	082	0.53	03
10479226	12	12	128	0.41	01

42MT



*Note: overcrank protection - OCP

New Service Part Number	Volts	Pinion Teeth	Switch Pos.	Mtg. Hole	Nose Hsg.
-------------------------	-------	--------------	-------------	-----------	-----------

POPULAR NEW SERVICE PART NUMBERS

1990483	12	11	052	0.66	03
1990484*	12	11	052	0.66	03
1990489*	12	11	088	0.66	03

New Service Part Number	Volts	Pinion Teeth	Switch Pos.	Mtg. Hole	Nose Hsg.
-------------------------	-------	--------------	-------------	-----------	-----------

POPULAR NEW SERVICE PART NUMBERS (CONT.)

1990490	12	11	088	0.66	03
10478810	12	11	308	0.66	03
10478998	24	11	038	0.66	03

50MT



New Service Part Number	Volts	Pinion Teeth	Switch Pos.	Mtg. Hole	Nose Hsg.
-------------------------	-------	--------------	-------------	-----------	-----------

POPULAR NEW SERVICE PART NUMBERS

10479323	24	11	068	0.66	03
10479339	24	11	038	0.66	03

Solenoid



New Service Part Number	Starter Applications	Switch Pos.
POPULAR NEW SERVICE PART NUMBERS		
1115593	42MT	12
1115595	42MT	24
1115598	42MT	12
1115609	37MT	12
1115610	37MT	12
1115618	37MT	12
1115621	37MT	24
1115622	37MT	24
1115624	42MT	12
1115627	37MT	24
1115638	41MT	12
1115639	41MT	12
1115640	41MT	24

New Service Part Number	Starter Applications	Switch Pos
POPULAR NEW SERVICE PART NUMBERS (CONT.)		
1115641	41MT	24
1115672	37MT	24
1115682	41MT	24
1115683	41MT	24
1115693	37MT	12
1115695	37MT	12
1115704	37MT	12
1115706	41MT	12
10511211	42MT	12
10511214	42MT	12
10511215	42MT	12
10511217	42MT	24
10511219	42MT	24

Semi Solid Link Solenoid



New Solenoid Technology Means...

- Higher Contact Weld Breaking Force
- Reduces Stuck Contact Failures Caused by Low System Voltage!
- Patented Design



PATENTED
SEMI-SOLID LINK SOLENOID

Plunger moves this distance and impacts the link producing the **Slide Hammer Effect!**

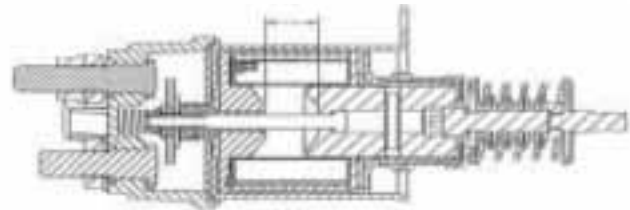

All 42MT and 50MT new service and remanufactured starters feature patented Delco Remy SSL Solenoids.

Conventional Part #	SSL Part#	Motor Family	Voltage	Conventional Part #	SSL Part#	Motor Family	Voltage
1115593	1115701	42MT	12	1115655	1115677	37MT	24
1115595	1115673	42MT	24	1115656	10511212	42MT	12
1115597	10511217	42MT	24	1115657	1115683	41MT	24
1115598	10511210	42MT	12	1115667	1115673	42MT	24
1115601	10511219	42MT	24	1115668	1115673	42MT	24
1115602	10511214	42MT	12	1115671	1115673	42MT	24
1115609	1115689	37MT	12	1115687	10511210	42MT	12
1115610	1115690	37MT	12	1115689	1115689	37MT	12
1115611	1115689	37MT	12	1115690	1115689	37MT	12
1115617	1115693	37MT	12	1115693	1115689	37MT	12
1115618	1115694	37MT	12	1115694	1115689	37MT	12
1115619	1115675	37MT	24	1115695	1115689	37MT	12
1115621	1115680	37MT	24	1115696	1115689	37MT	12
1115622	1115674	37MT	24	1115693	1115689	37MT	12
1115623	1115695	37MT	12	1115700	1115689	37MT	12
1115624	10511213	42MT	12	1115704	1115689	37MT	12
1115625	1115683	42MT	24	10456392	1115689	37MT	12
1115627	1115676	37MT	24	10456394	1115673	37MT	24
1115628	1115697	37MT	12	10461516	10511210	42MT	12
1115633	10511215	42MT	12				
1115633	1115673	42MT	24				
1115634	1115682	41MT	24				
1115638	1115701	41MT	12				
1115639	1115702	41MT	12				
1115640	1115678	41MT	24				
1115641	1115673	41MT	24				
1115642	10511211	42MT	12				
1115643	1115704	37MT	12				
1115652	1115672	37MT	24				
1115653	1115706	41MT	12				

REMAN SSL			
Conventional Part #	SSL Part#	Motor Family	Voltage
1115673	1115673	42MT	24MT
10456392	1115689	37MT	12V
10456393	10512653	42MT	12V
10456394	1115673	42MT	24V
10461516	10511210	42MT	12V
			Rev Term

Low Voltage Disconnect



O.E. Number	Service by (Pkg.) Part Number	Amps	Voltage Set Point	O.E. Number	Service by (Pkg.) Part Number	Amps	Voltage Set Point
NEW SERVICE PART NUMBERS				NEW SERVICE PART NUMBERS (CONT.)			
19020475	10500242	50A	12.1V	19020496	10500242	50A	12.1V
19020477	10500389	50A	12.3V	19020497	10500451	100A	12.1V
19020479	10500242	50A	12.1V	19020492	10502363	70A	12.3V
19020480	10500389	50A	12.3V	19020494	10500389	50A	12.3V
19020486	10500242	50A	12.1V	19020498	10500389	50A	12.3V
19020490	10500242	50A	12.1V	19020499	10502122	100A	12.3V

Magnetic Switch



Part Number	Volt	Terminal	Description	Part Number	Volt	Terminal	Description
POPULAR NEW SERVICE PART NUMBERS				POPULAR NEW SERVICE PART NUMBERS (CONT.)			
1114532	12	3	Dash Mount	1114545	12	3	Motor Mount
1114534	12	4	Dash Mount	1114547	12	4	Dash Mount
1114536	24	4	Dash Mount, Fungus & Corrosion Protection	1114548	12	3	Motor Mount
1114537	12	4	Dash Mount, Fungus & Corrosion Protection	1114549	12	4	Motor Mount, Special Circuit
1114538	12	3	Dash Mount	1115592	36	4	Dash Mount
1114540	6	3	Dash Mount	1115615	24	4	Dash Mount
1114543	6	4	Dash Mount	1115616	12	4	Dash Mount
				1115636	24	4	Dash Mount

Bench Top Tester



Remy Number	Description
NEW SERVICE PART NUMBERS	
10457728	5hp 230V, Single Phase
10457729	5hp 230V, Three Phase
10457771	5hp, 480V, Three Phase

Remy Number	Description
NEW SERVICE PART NUMBERS (CONT.)	
10500123	Bracket for QUAD Mount Alternators

Intelli-Check2™ (Systems Analyzer)



Remy Number	Description
NEW SERVICE PART NUMBERS	
10503560	Tester, Printer, Case
10512657	Tester Only
10503176	Printer Only

Remy Number	Description
NEW SERVICE PART NUMBERS (CONT.)	
10512658	Case Only
10512661	PC Adapter
10503559	45' Lead Kit (Bus & Coach)



Power Inverters

- Transforms the DC power stored in the truck's batteries to AC power
- Does not create AC power, it transforms it.
- Provides reliable power for work and leisure.
- Allows the use of standard electronics, appliances & tools
 - TV, VCR, Stereo, Games
 - Microwave, Coffee Maker, Toaster
 - Drill, Flood Light, Air Compressor
 - Computer, Printer, Fax, Phone



Part No. 19021005
150 Watt Power Inverter
(Plugs into vehicle 12V DC outlet)



Part No.
19021004
10500419
Description
400 Watt Power Inverter
400 Watt Installation Kit



Part No.
19021006
10500478
Description
600 Watt Power Inverter
600 Watt Installation Kit



Part No.
19021007
10500479
Description
1000 Watt Power Inverter
1000 Watt Installation Kit



Part No.
19021003
10500418
Description
1750 Watt Power Inverter
1750 Watt Installation Kit

All inverters (except the 150 Watt) require a specific installation kit.

The installation kit comes complete with all necessary cables, hardware, and instructions.



Installation Kits

- | | |
|----------|----------------------------|
| 10500419 | 400 Watt Installation Kit |
| 10500478 | 600 Watt Installation Kit |
| 10500479 | 1000 Watt Installation Kit |
| 10500418 | 1750 Watt Installation Kit |

Miscellaneous





Power Inverters

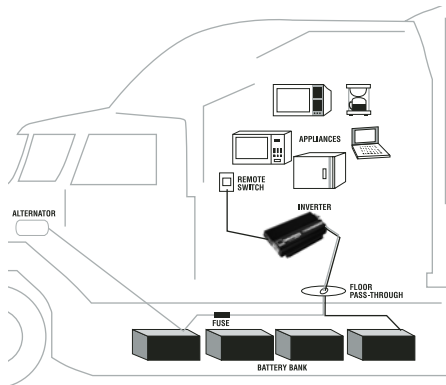

Remy Power Inverter's are better because...

- Proven Remy Quality
- Ideal for Heavy Duty Applications
- System Matched Installation Kits
- Auto Shutdown Prevents Total Battery Discharge
- Set Point 11.8v DC vs 10.3 or Less for Competitive
- Over-Temperature and Over-Current Shut-down

How Much Power Do You Need?



PART NUMBER	19021005	19021004	19021006	19021007	19021003
INSTALL KIT PART NUMBER	N/A	10500419	10500478	10500479	10500418
INVERTER TYPE	150W	400W	600W	1000W	1750W
Equipment Operated:					
Small TV	Y	Y	Y	Y	Y
Small TV/VCR Combo	Y	Y	Y	Y	Y
Video Games	Y	Y	Y	Y	Y
Laptop Computer	Y	Y	Y	Y	Y
Cell Phone Charger	Y	Y	Y	Y	Y
20" Television	Y	Y	Y	Y	Y
Audio System	Y	Y	Y	Y	Y
Coffee Maker	N	Y	Y	Y	Y
Small Appliance	N	Y	Y	Y	Y
Small Fan	N	Y	Y	Y	Y
Large Fan	N	Y	Y	Y	Y
Small Power Tools	N	N	Y	Y	Y
Multiple Appliances	N	N	Y	Y	Y
Large Power Tools	N	N	N	Y	Y
Small Microwave	N	N	N	Y	Y
Mid-Size Microwave	N	N	N	N	Y
3 cu. Ft. Refrigerator	N	N	N	N	Y
Hair Dryer	N	N	N	N	Y

Miscellaneous

35SI™ Upgrade Program

Many trucks on the road today are equipped with Delco Remy 33SI and 34SI premium brushless alternators. The truck OEM's and truck owners know that these premium products offer exceptional cost per mile benefits. To keep these trucks operating with the best charging system, it will be important to maintain this spec when it comes time for replacement.

Now Remy has introduced the new Delco Remy 35SI Premium Brushless Alternator with heat resistant design to operate in under-hood temperatures of up to 105°C/221°F. With the 35SI Upgrade Program, you can convert any truck with a 33SI or 34SI to the new high temperature 35SI model and receive full core credit for each 33SI and 34SI core returned. (See back for part number information) Effective 1/1/05, 33SI, 34SI, 35SI and 35SI HPs will become one core group based on mounting style.

Here's how it works using Genuine Delco Remy remanufactured units:

Three Core Groups Separated By Similar Mounting Style

REMOVED UNIT	REPLACEMENT UNIT 35SI	AMOUNT OF CORE CREDIT UP TO ELIGIBILITY
33SI J180 Hinge Mount	See Chart on Page 5	Full Core Credit
35SI J180 Quad Mount	See Chart on Page 5	Full Core Credit
34SI Pad Mount	See Chart on Page 5	Full Core Credit

Mounting Compatible Core Groups



33SI

← **J180 Hinge Mount** →



35SI



34SI

← **J180 Quad Mount** →



35SI



34SI

← **Pad Mount** →



35SI

Remote Sense Technology

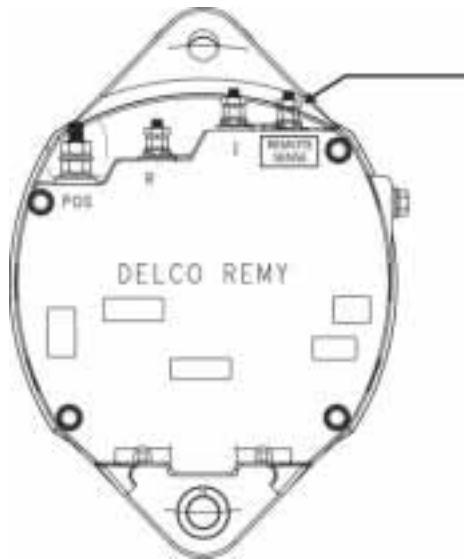

Some 35SI alternators feature Remote Sense Technology that senses the voltage level at the batteries and adjusts alternator output accordingly. A direct connection from the alternator's fourth terminal to the batteries provides highly accurate voltage readings and optimizes battery state of charge.

Without Remote Sense



14.0	Standard Volts at Alternator
- .2	Voltage Drop
- .3	Voltage Drop
<hr/>	
13.5	Volts at Batteries

With Remote Sense

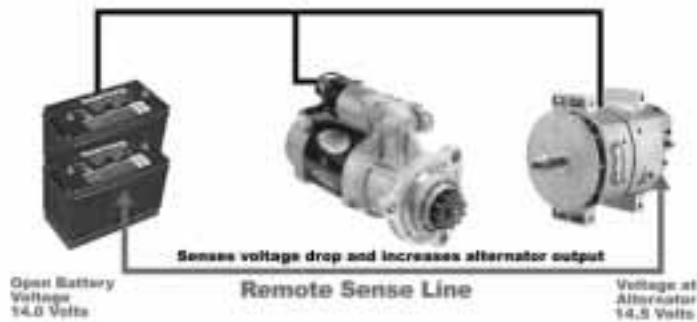

14.5	Volts at Alternator
- .2	Voltage Drop
- .3	Voltage Drop
<hr/>	
14.0	Volts at Batteries

Is Your Vehicle in Spec?

Starting performance can be adversely affected by electrical system voltage drops.



The Maintenance Council (TMC) specifies cranking circuit voltage drop of not more than 1/2 volt for a 12-volt system and one volt for a 24-volt system. TMC also states the control circuit must have a maximum drop at 80 amps of one volt for a 12-volt system; maximum drop at 40 amps is two volts on a 24-volt system.

Common Causes of Cranking Circuit Voltage Drop

- Corrosion of the terminals or cables
- Loose terminal or ground connections
- Undersized cables
- Battery cables that do not originate in close proximity to the starter

Cranking circuit
Control circuit
Magnetic switch (relay)
Charging circuit

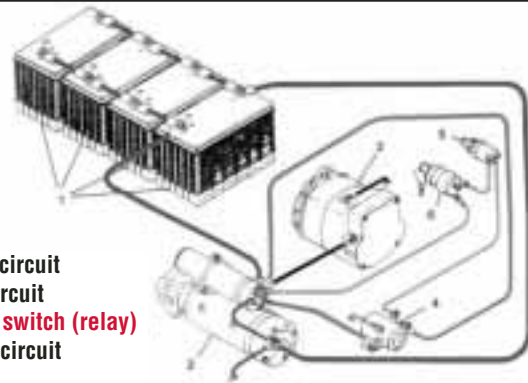

Remy Inc. Integral Magnetic Switch

Most OEMs have included magnetic “relay” switches in the design of the vehicle to transmit control circuit current. Many of these relays cannot successfully handle the amperage requirements of the starting motor. This may adversely affect starting performance.

Remy’s solution is the optional, OEM-approved heavy-duty Integral Magnetic Switch (IMS) attached directly to each Class 7 and 8 MxT starter, ensuring a far more robust and reliable circuit for starting the motor. The Delco Remy IMS Solution reduces amperage draw on the control circuit from 300 Amps to 4 Amps, ensuring optimal operation and reliability.

IMS Switch



The Delco Remy **42MT** straight drive starter, with mechanical soft start, creates lower demand on the control circuit at start-up because of lower current draw on the solenoid.

To test whether your vehicle is in spec, use the Remy® Intelli-Check2™ hand-held diagnostic tool.



Testing with heavy-duty straight drive and MxT starters shows that for every one volt of drop in a system, the cold-crank engine RPM is reduced by 28 RPM.



MxT™ Application Index

Engine	Application	OE Model	Non IMS Reman	New Service Unit w/ IMS	Reman w/ IMS	Volts	Overcrank Protection
29MT							
Cummins ISB	International All Models	19011409	10461765	NA	NA	12	
Cummins ISB (LH)	Freightliner FL 50,60,70,80 - FC 70, 80, - Condor, All Sterling Models	19011402	10461771	NA	NA	12	
Cummins ISB (RH)	Freightliner FL 50,60,70,80 - FC 70, 80, - Condor	8200010	10461770	NA	NA	12	
Cummins ISB (RH)	Freightliner FL 50,60,70,80 - FC 70, 80, - Condor	19011400	10461770	NA	NA	12	
International VT365	International All Models	19011407	10461764	NA	NA	12	
Mercedes BR904/906	Freightliner	8200011	10461772	NA	NA	12	
Mercedes BR904/906	Freightliner FL 50,60,70,80 - FC 70, 80	19011403	10461772	8200103*	NA	12	
38MT							
Caterpillar 3126/C7	Freightliner FL 50,60,70,80 - FC 70, 80, - Condor Work Horse	19026027	10461768	8200076*	8300021*	12	
Cummins ISB	Various Off Road	19026031 8200023	x	8200077*	8300024*	12	
Cummins ISB	Various Off Road	19026032 8200024	x	8200078*	8300023*	24	
Cummins ISC	Various Off Road/Nova Bus/FG Wilson	19026030 19026026 8200072* 8200000	x	8200072*	8300025*	24	
Cummins ISC/ISL International DT466	Freightliner FL 50,60,70,80 - FC 70, 80, - Condor	19026028 19026029 8200025*	x	8200005*	8300005*	12	
International T444E	International	8200007*	x	8200007*	8300022*	12	
Mercedes Benz BR926 (7.25L)	Freightliner FL 50,60,70,80 - FC 70, 80	19026035	x	8200075*	8300026*	12	
39MT							
Cummins ISC (8.3L)	Various off road	19011524* 19011511 8200029	10461758	19011524*	8300014*	24	
Cummins ISC (8.3L)	Various off road	19011512 8200027	10461759	8200086*	8300011*	24	
Cummins ISC (8.3L)	Various off road	19011513 8200028	10461760	8300085*	8300012*	12	
Cummins ISC/ ISL	Various off road - Freightliner FL 50,60,70,80 - FC 70, 80, - Condor, Mack w/ ISL	19011517 19011510 8200030	10461757	8200087*	8300015*	12	
Cummins ISX	Volvo VN Series - Freightliner C112 / C120 Century Class - CL121 - FLD 112 / 112SD International Trucks	19011529* 19011530 19011516 19011518 8200040 8200033	10461753	19011529*	8300019*	12	
Cummins ISX Detroit Diesel S60 Caterpillar C15	Freightliner	19011521	x	8200083*	8300009*	12	OCP
Volvo D12	Volvo VN Series	19011515*	x	19011515*	8300004*	12	
Cummins ISX/ ISL	Freightliner	19011526	x	8200081*	8300007*	12	OCP
Cummins ISX/ ISM	Various off road	8200038 8200031	10461755	8200088*	8300017*	12	
Cummins ISX/ ISM DDC S60	Various off road	19011522* 8200041 8200034	10461754	19011522*	8300018*	24	
Cummins ISX/ ISM	Various off road	19011523* 8200039 8200032	10461756	19011523*	8300016*	24	
Mack E7	Mack	19011531 8200037*	10461334	8200037*	8300020*	12	
Mack E7	Mack	8200022*	x	8200022*	x	24	
MBE 4000	Freightliner C112 / C120 Century Class - CL121 - FLD 112/ 112SD	19011514	10461773	8200084*	8300013*	12	
MBE 4000	Freightliner	19011525	x	8200082*	8300008*	12	OCP
Caterpillar C12/C15 Cummins ISX	Volvo VN Series, Freightliner C112 / C120 Century Class - CL121 - FLD 112 / 112SD International Aftermarket	8200090*	x	8200090*	x	12	OCP

*IMS

Part Number	Reman Number	Pg	Series
AC Delco			
321-38	19020501	7	10SI
321-39	19020501	7	10SI
321-40	19020501	7	10SI
321-41	19020501	7	10SI
321-42	19020501	7	10SI
321-43	19020501	7	10SI
321-45	19020501	7	10SI
321-46	19020501	7	10SI
321-47	19020501	7	10SI
321-48	19020501	7	10SI
321-49	19020504	20	27SI
321-134	19020501	7	10SI
321-135	19020501	7	10SI
321-136	19020504	20	27SI
321-137	19020506	10	15SI
321-138	19020506	10	15SI
321-139	19020506	10	15SI
321-143	19020501	7	10SI
321-148	19020501	7	10SI
321-231	19020501	7	10SI
321-234	19020506	10	15SI
321-357	19020505	9	12SI
321-603	10463072	20	27SI
321-604	10463074	20	27SI
321-605	10463073	20	27SI
321-608	19020500	7	10SI
321-641	10459004	21	30SI
321-642	10459016	21	30SI
321-643	10459009	21	30SI
321-644	10459010	21	30SI
321-645	1117746	21	30SI
321-646	10459325	21	30SI
321-647	19020500	7	10SI
321-648	19020500	7	10SI
321-649	19020500	7	10SI
321-651	10459526	7	10SI
321-652	19020521	7	10SI
321-654	10459244	20	27SI
321-660	1117655	11	20SI
321-665	10459319	11	20SI
321-666	10459020	11	20SI
321-667	10459367	10	15SI
321-669	10459069	20	27SI
321-670	10459008	21	30SI
321-671	10459057	21	30SI
321-674	10459013	13	21SI
321-676	10459046	13	21SI
321-677	10459453	13	21SI
321-679	10463160	20	27SI
321-680	10463161	20	27SI
321-681	10459013	13	21SI
321-682	10459013	13	21SI
321-683	10459037	13	21SI
321-684	10459037	13	21SI
321-685	10459013	13	21SI
321-687	10459037	13	21SI
321-688	10459051	13	21SI
321-689	10459051	13	21SI
321-693	10459298	27	50DN Gear Drive
321-694	10459297	27	50DN Gear Drive
321-695	10459299	26	50DN Belt Drive
321-696	10459097	21	30SI
321-697	10459076	17	25SI and 26SI
321-698	10459064	17	25SI and 26SI
321-699	10459067	18	25SI and 26SI
321-700	10459065	18	25SI and 26SI

Part Number	Reman Number	Pg	Series
AC Delco (cont.)			
321-701	10459013	13	21SI
321-702	10459077	18	25SI and 26SI
321-703	10459021	46	JB Series
321-704	10459022	46	JB Series
321-705	10459080	46	JB Series
321-706	10459081	46	JB Series
321-707	10459066	18	25SI and 26SI
321-708	10459079	21	30SI
321-710	10459120	21	30SI
321-711	10459121	27	50DN Gear Drive
321-712	10459122	27	50DN Gear Drive
321-713	10459123	26	50DN Belt Drive
321-713	10459250	26	50DN Belt Drive
321-714	10459124	27	50DN Gear Drive
321-715	10459013	13	21SI
321-716	10459037	13	21SI
321-717	10459051	13	21SI
321-718	10459013	13	21SI
321-719	10459013	13	21SI
321-720	10459037	13	21SI
321-721	10459051	13	21SI
321-726	10459161	18	25SI and 26SI
321-731	10459141	23	33SI
321-732	10459142	23	33SI
321-733	10459143	23	33SI
321-734	10459144	23	33SI
321-735	10459145	23	34SI QUAD Mount
321-737	10459187	13	21SI
321-738	10459188	15	22SI
321-739	10459189	15	22SI
321-740	10459190	15	22SI
321-741	10459206	23	34SI QUAD Mount
321-742	10463161	20	27SI
321-743	10459238	20	27SI
321-746	10459297	27	50DN Gear Drive
321-748	10459196	23	33SI
321-749	10459205	15	22SI
321-750	10459204	15	22SI
321-751	10459246	21	30SI
321-752	10459245	18	25SI and 26SI
321-753	10459252	11	20SI
321-754	10459258	21	30SI
321-755	10459259	21	30SI
321-756	10459261	13	21SI
321-757	10459287	23	34SI QUAD Mount
321-758	10459288	24	34SI PAD Mount
321-759	10459274	16	23SI
321-760	10459277	16	23SI
321-761	10459218	16	23SI
321-762	10459275	16	23SI
321-763	10459279	24	34SI PAD Mount
321-764	10459278	24	34SI PAD Mount
321-767	10459316	10	19SI
321-769	10459311	23	33SI
321-770	19020509	57	Motorola
321-771	19020510	57	Motorola
321-772	19020515	59	Motorola
321-773	19020512	58	Motorola
321-774	19020515	59	Motorola
321-775	19020520	60	Motorola
321-796	10459481	15	22SI PAD Mount
321-797	10459482	15	22SI PAD Mount
321-798	10459483	15	22SI PAD Mount
321-1015	19020528	9	12SI
321-1762	19020500	7	10SI
321-1764	19020529	9	12SI

Part Number	Reman Number	Pg	Series
AC Delco (cont.)			
321-1768	19020527	7	10SI
323-255	10465171	75	10MT
323-278	10461070	78	27MT
323-408	10461453	79	28MT
323-419	10465043	79	28MT
323-437	10465295	79	28MT
323-438	10461446	79	28MT
323-439	10461447	79	28MT
323-440	10461448	79	28MT
323-442	10461450	79	28MT
323-446	10465296	79	28MT
323-447	10465168	79	28MT
323-448	10465315	79	28MT
323-450	10461487	79	28MT
323-451	10461445	79	28MT
323-482	10465239	79	28MT
323-484	10465153	75	10MT
323-486	10461452	80	28MT
323-487	10465365	80	28MT
323-504	10465151	80	28MT
323-611	10461059	89	40MT
323-614	10461071	89	40MT
323-622	1114786	89	40MT
323-623	10461060	89	40MT
323-631	10461613	75	10MT
323-632	10461605	75	10MT
323-633	10461599	75	10MT
323-636	10461606	75	10MT
323-639	10461612	75	10MT
323-642	10461602	77	20, 22, 25MT
323-645	10461603	75	10MT
323-648	10461620	75	10MT
323-651	10461597	75	10MT
323-652	10461600	75	10MT
323-653	10461611	75	10MT
323-655	10461617	75	10MT
323-673	10461598	77	20, 22, 25MT
323-675	10461616	77	20, 22, 25MT
323-677	10461609	77	20, 22, 25MT
323-681	10461615	77	20, 22, 25MT
323-692	10461610	77	20, 22, 25MT
323-695	10461678	77	20, 22, 25MT
323-751	10459246	21	30SI
323-761	10461057	99	50MT
323-762	1109792	99	50MT
323-763	1109793	99	50MT
323-765	1109795	99	50MT
323-766	10461161	99	50MT
323-767	10461159	99	50MT
323-769	10461499	99	50MT
323-773	10461045	89	40MT
323-774	10461046	89	40MT
323-775	10461047	89	40MT
323-776	10461073	89	40MT
323-777	10461107	89	40MT
323-781	10461047	89	40MT
323-782	1990210	89	40MT
323-789	10461056	99	50MT
323-790	1109555	99	50MT
323-791	1990220	89	40MT
323-818	10461044	83	37MT
323-823	10465149	78	27MT
323-826	10465347	78	27MT
323-829	10461010	83	37MT
323-829	10461051	95	42MT
323-830	10461050	95	42MT

INTERCHANGE

Part Number	Reman Number	Pg	Series
AC Delco (cont.)			
323-833	10465315	80	28MT
323-834	10461069	83	37MT
323-835	10461001	83	37MT
323-836	10461303	83	37MT
323-837	10461003	83	37MT
323-840	10461058	83	37MT
323-842	10461089	83	37MT
323-843	10461066	83	37MT
323-844	10461010	83	37MT
323-845	10461058	83	37MT
323-847	10461013	83	37MT
323-849	10461015	83	37MT
323-850	10461016	83	37MT
323-852	10461018	83	37MT
323-854	10461020	95	42MT
323-855	10461021	95	42MT
323-856	10461133	95	42MT
323-857	10461132	95	42MT
323-858	10461068	95	42MT
323-859	10461025	95	42MT
323-864	10461055	95	42MT
323-865	10461137	95	42MT
323-866	10461134	95	42MT
323-867	10461052	95	42MT
323-871	10461053	95	42MT
323-872	10461054	95	42MT
323-873	10461075	95	42MT
323-874	10461233	95	42MT
323-877	10461077	95	42MT
323-878	10461141	95	42MT
323-879	10461098	83	37MT
323-880	10461110	83	37MT
323-882	10461091	95	42MT
323-883	10461131	95	42MT
323-884	10461108	83	37MT
323-885	10461209	83	37MT
323-886	10461084	83	37MT
323-886	10461084	83	37MT
323-887	10461207	83	37MT
323-888	10461209	83	37MT
323-889	10461172	95	42MT
323-890	10461151	95	42MT
323-891	10461165	95	42MT
323-892	10461164	95	42MT
323-893	10461163	95	42MT
323-894	10461162	95	42MT
323-897	10461171	91	41MT
323-898	10461078	95	42MT
323-900	10461169	83	37MT
323-901	10461170	83	37MT
323-902	10461096	95	42MT
323-907	10461209	83	37MT
323-908	10461209	83	37MT
323-910	10461089	83	37MT
323-911	10461468	80	28MT
323-912	10461209	83	37MT
323-913	10461209	83	37MT
323-914	10461297	83	37MT
323-915	10461298	83	37MT
323-917	10461299	83	37MT
323-918	10461300	83	37MT
323-919	10461301	83	37MT
323-920	10461302	83	37MT
323-921	10461318	91	41MT
323-922	10461324	95	42MT
323-924	10461326	95	42MT

Part Number	Reman Number	Pg	Series
AC Delco (cont.)			
323-925	10461166	95	42MT
323-926	10461079	95	42MT
323-927	10461135	95	42MT
323-928	10461341	95	42MT
323-930	10461353	95	42MT
323-931	10461351	95	42MT
323-932	10461140	95	42MT
323-933	10461358	95	42MT
323-934	10461360	95	42MT
323-937	10461410	95	42MT
323-938	10461160	99	50MT
323-939	10461167	99	50MT
323-942	10461378	99	50MT
323-944	10461382	99	50MT
323-945	10461388	95	42MT
323-946	10461408	91	41MT
323-947	10461409	91	41MT
323-948	10461415	95	42MT
323-949	10461411	95	42MT
323-950	10461416	83	37MT
323-951	10461417	91	41MT
323-952	10461412	95	42MT
323-953	10461413	95	42MT
323-954	10461414	95	42MT
323-956	10461407	99	50MT
323-957	10461406	99	50MT
323-958	10461405	83	37MT
323-959	10461404	83	37MT
323-966	10461418	95	42MT
323-984	10461443	80	28MT
323-987	10461525	83	37MT
323-971	10465440	123	Nippondenso
323-972	10465442	123	Nippondenso
323-973	10465444	124	Nippondenso
323-974	10465445	124	Nippondenso
323-969	10465437	105	Hitachi
323-970	10465438	105	Hitachi
323-1187	10465349	80	28MT
323-1188	10465150	80	28MT
323-1189	10465348	80	28MT
323-1193	10465409	75	10MT
323-1194	10465410	75	10MT
323-1195	10465411	75	10MT
323-1196	10465412	75	10MT
323-1197	10465413	75	10MT
323-1198	10465414	75	10MT
323-1199	10465415	75	10MT
323-1200	10465416	75	10MT
323-1201	10465352	75	10MT
323-1202	10465418	75	10MT
323-1203	10465419	75	10MT
Berman			
DS-01	10465155	75	10MT
DS-07	10461047	89	40MT
DS-08	10461060	89	40MT
DS-10	10461045	89	40MT
DS-10	10461052	95	42MT
DS-10	10461053	95	42MT
DS-11	10461046	89	40MT
DS-11	10461052	95	42MT
DS-12	10461057	99	50MT
DS-14	1109792	99	50MT
DS-15	1109793	99	50MT
DS-16	1109795	99	50MT
DS-26	10465411	75	10MT

Part Number	Reman Number	Pg	Series
Berman (cont.)			
DS-37	10461360	95	42MT
DS-38	10461358	95	42MT
DS-44	10465419	75	10MT
DS-45	10465149	78	27MT
DS-48	10465043	80	28MT
DS-49	10461450	80	28MT
DS-50	10465151	80	28MT
DS-52	10465168	80	28MT
DS-55	10461446	80	28MT
DS-62	10465348	80	28MT
Bosch			
0-001-359-016	10461622	100	Bosch
0-001-359-090	10461622	100	Bosch
0-001-362-016	10461637	101	Bosch
0-001-362-034	10461637	101	Bosch
0-001-362-305	10461637	101	Bosch
0-001-362-310	10461638	101	Bosch
0-001-362-312	10461639	101	Bosch
0-001-362-316	10461639	101	Bosch
0-001-362-527	10461638	101	Bosch
0-001-367-075	10461622	100	Bosch
0-001-367-078	10461622	100	Bosch
0-001-369-001	10461622	100	Bosch
0-001-369-005	10461622	100	Bosch
0-120-339-514	10459522	34	Bosch
0-120-339-531	10459522	34	Bosch
0-120-468-028	10459498	32	Bosch N1
0-120-468-054	10459503	33	Bosch N1
0-120-468-055	10459510	33	Bosch N1
0-120-468-136	10459505	33	Bosch
0-120-484-011	10459499	30	Bosch K1
0-120-488-206	19020536	32	Bosch K1
0-120-489-475	10459500	30	Bosch K1
0-120-489-481	10459501	31	Bosch K1
0-120-489-703	10459520	31	Bosch K1
0-120-489-704	10459520	31	Bosch K1
0-120-689-503	19025330	142	Bosch T1 (New)
0-120-689-506	19025336	142	Bosch T1 (New)
0-120-689-507	19025333	142	Bosch T1 (New)
0-120-689-508	19025330	142	Bosch T1 (New)
0-120-689-511	19025331	142	Bosch T1 (New)
0-120-689-512	19025330	142	Bosch T1 (New)
0-120-689-513	19025330	142	Bosch T1 (New)
0-120-689-517	19025333	142	Bosch T1 (New)
0-120-689-520	19025330	142	Bosch T1 (New)
0-120-689-522	19025333	142	Bosch T1 (New)
0-120-689-526	19025335	142	Bosch T1 (New)
0-120-689-527	19025333	142	Bosch T1 (New)
0-120-689-530	19025330	142	Bosch T1 (New)
0-120-689-533	19025330	142	Bosch T1 (New)
0-120-689-535	19025330	142	Bosch T1 (New)
0-120-689-540	19025333	142	Bosch T1 (New)
0-120-689-541	19025333	142	Bosch T1 (New)
0-120-689-542	19025333	142	Bosch T1 (New)
0-120-689-545	19025330	142	Bosch T1 (New)
0-120-689-546	19025333	142	Bosch T1 (New)
0-120-689-548	19025331	142	Bosch T1 (New)
0-120-689-552	19025337	142	Bosch T1 (New)
0-120-689-556	19025337	142	Bosch T1 (New)
0-120-689-567	19025333	142	Bosch T1 (New)
0-120-689-571	19025330	142	Bosch T1 (New)
0-122-469-002	10459511	34	Bosch
0-122-469-004	10459511	34	Bosch
0-986-031-600	19025330	142	Bosch T1 (New)
0-986-033-520	19025330	142	Bosch T1 (New)

Part Number	Reman Number	Pg	Series
Bosch (cont.)			
0-986-033-550	19025330	142	Bosch T1 (New)
0-986-034-610	19025331	142	Bosch T1 (New)
0-986-034-910	19025330	142	Bosch T1 (New)
0-986-037-420	19025330	142	Bosch T1 (New)
0-986-038-290	19025330	142	Bosch T1 (New)
0-986-039-140	19025335	142	Bosch T1 (New)
0-986-039-530	19025333	142	Bosch T1 (New)
6-004-MLO-004	10459537	35	Bosch
9-120-060-023	19020508	35	Bosch
9-120-060-027	19020507	35	Bosch
9-120-060-040	10459506	31	Bosch K1
9-120-060-041	10459508	35	Bosch
9-120-080-144	19020535	32	Bosch K1
9-127-041-233	19020581	36	Bosch
9-127-041-241	19020581	36	Bosch
9-127-041-242	19020581	36	Bosch
Cargo			
110075	10459344	7	10SI
110233	10459343	7	10SI
110233	10459344	7	10SI
110233	10459343	7	10SI
110234	10463161	20	27SI
110235	10459452	20	27SI
110300	10459244	20	27SI
110301	10461047	89	40MT
110302	10461047	89	40MT
110347	10461057	99	50MT
110416	10459065	18	25SI and 26SI
110416	10459077	18	25SI and 26SI
110436	10461046	89	40MT
110469	10465352	75	10MT
110499	10463161	20	27SI
110504	10459343	7	10SI
110504	10459365	7	10SI
110505	10459343	7	10SI
110505	10459344	7	10SI
110505	10459343	7	10SI
110508	10459344	7	10SI
110590	10461450	80	28MT
110591	10459064	18	25SI and 26SI
110591	10459076	18	25SI and 26SI
110591	10459077	18	25SI and 26SI
110603	10465149	78	27MT
110603	10465043	80	28MT
110999	10461358	95	42MT
111000	10461068	95	42MT
111038	10465348	80	28MT
111039	10461045	89	40MT
111041	10461446	80	28MT
111049	10465411	75	10MT
111221	10465347	78	27MT
111221	10461443	80	28MT
111222	10461484	80	28MT
111255	10465295	80	28MT
111256	10465168	80	28MT
111260	10465419	75	10MT
111261	10459064	18	25SI and 26SI
111383	10465349	80	28MT
110235	19020506	10	15SI
110801	10459319	11	20SI
111232	10459013	13	21SI
Carrier			
20-44-3325	19020509	57	Motorola
20-44-6257	19020510	57	Motorola

Part Number	Reman Number	Pg	Series
Carrier (cont.)			
20-45-1263	10465438	105	Hitachi
20-45-1285	10465437	105	Hitachi
20-45-1312	10465440	123	Nippondenso
20-45-1671	10465438	105	Hitachi
20-045-1251	10465444	124	Nippondenso
25-35465-00	10465529	125	Nippondenso
25-37640-00	10465531	126	Nippondenso
25-37725-00	10465531	126	Nippondenso
25-38750-00	10465531	126	Nippondenso
25-39135-00	10465531	126	Nippondenso
25-39316-00	10465445	124	Nippondenso
30-00171-00	19020520	60	Motorola
30-00171-11	19020520	60	Motorola
30-00228-00	19020520	60	Motorola
30-00251-11	19020509	57	Motorola
30-00331-00	19020509	57	Motorola
30-00308-01	10465445	124	Nippondenso
30-00308-02	10465445	124	Nippondenso
30-00349-01	19020546	62	Motorola
30-00351-00	19020520	60	Motorola
30-00351-02	19020520	60	Motorola
30-00351-04	19020520	60	Motorola
30-00363-00	19020546	62	Motorola
30-00363-01	19020546	62	Motorola
30-00363-03	19020546	62	Motorola
30-00363-04	19020546	62	Motorola
30-00393-00	19020581	36	Bosch
30-00393-02	19020581	36	Bosch
30-00409-02	19020519	59	Motorola
30-00409-04	19020519	59	Motorola
30-00409-06	19020519	59	Motorola
30-00409-06	19020514	58	Motorola
30-00409-07	19020519	59	Motorola
30-00409-10	19020519	59	Motorola
30-00423-00	19020546	62	Motorola
30-50005	19020545	61	Motorola
30-50009-00	19020545	61	Motorola
30-50307-00	19020546	62	Motorola
Champion			
211	10456390	133	Solenoid
260	10456391	133	Solenoid
265	10456393	133	Solenoid
6060	10459080	46	JB Series
6061	10459021	46	JB Series
6062	10459022	46	JB Series
6063	10459081	46	JB Series
6940	19020309	138	22SI (New)
Chev/GMC			
94052173	10461518	112	Nippondenso
94052175	10461520	113	Nippondenso
94052177	10461519	112	Nippondenso
94052179	10459440	63	Nippondenso
94052181	10459439	63	Nippondenso
94052183	10459465	66	Nippondenso
94052185	10459466	44	Hitachi
94052185	10459445	65	Nippondenso
94052393	10459441	64	Nippondenso
94052403	10459437	43	Hitachi
94052405	10459444	65	Nippondenso
94052406	10459442	64	Nippondenso
94052407	10459443	64	Nippondenso
94052837	10461521	113	Nippondenso
97116697	10459467	45	Hitachi
97147778	10461527	113	Nippondenso

Part Number	Reman Number	Pg	Series
Chev/GMC (cont.)			
97189649	10459435	43	Hitachi
97189649	10459435	43	Hitachi
97189650	10459447	44	Hitachi
97189650	10459448	44	Hitachi
2095000	10459583	36	Chrysler
4428082	10459518	36	Chrysler
5227267	10459518	36	Chrysler
5233160	10459518	36	Chrysler
5233508	10459518	36	Chrysler
Cummins Recon			
3016628RX	10459020	11	20SI
3575130RX	10461483	80	28MT
3603848RX	10459064	18	25SI and 26SI
3603850RX	10459077	18	25SI and 26SI
3603851RX	10463072	20	27SI
3603851RX	10463073	20	27SI
3603852RX	10463074	20	27SI
3603853RX	10459244	20	27SI
3603854RX	10459009	21	30SI
3603857RX	10459022	46	JB Series
3603858RX	10459458	46	JB Series
3603858RX	19020308	138	22SI (New)
3603859RX	10459458	46	JB Series
3603859RX	19020308	138	22SI (New)
3603862RX	10461047	89	40MT
3603863RX	10461045	89	40MT
3603864RX	10461046	89	40MT
3603865RX	10461059	89	40MT
3603868RX	10461057	99	50MT
3603869RX	10456391	133	Solenoid
3603870RX	10456390	133	Solenoid
3603877RX	10459004	21	30SI
3603877RX	10459008	21	30SI
3604225RX	10459076	18	25SI and 26SI
3604230RX	10456390	133	Solenoid
3604231RX	10456391	133	Solenoid
3604232RX	10461073	89	40MT
3604233RX	10461107	89	40MT
3604234RX	10459459	46	JB Series
3604234RX	19020309	138	22SI (New)
3604321RX	10461068	95	42MT
3604322RX	10461052	95	42MT
3604323RX	10461010	83	37MT
3604323RX	10461021	95	42MT
3604324RX	10461133	95	42MT
3604473RX	10459020	11	20SI
3604474RX	10459367	10	15SI
3604475RX	19020500	7	10SI
3604476RX	19020527	7	10SI
3604482RX	10465149	78	27MT
3604483RX	10461089	83	37MT
3604484RX	10461358	95	42MT
3604485RX	10465540	129	Nippondenso
3604486RX	10465528	125	Nippondenso
3604492RX	10461046	89	40MT
3604493RX	10461046	89	40MT
3604645RX	1109555	99	50MT
3604645RX	1109792	99	50MT
3604647RX	10459065	18	25SI and 26SI
3604649RX	10456393	133	Solenoid
3604651RX	10456393	133	Solenoid
3604652RX	10459008	21	30SI
3604652RX	10459097	21	30SI
3604652RX	10459258	21	30SI

INTERCHANGE



Part Number	Reman Number	Pg	Series
Cummins Recon (cont.)			
3604654RX	10465043	80	28MT
3604654RX	10465365	80	28MT
3604655RX	1109793	99	50MT
3604659RX	10459238	20	27SI
3604660RX	10465540	129	Nippondenso
3604663RX	19020501	7	10SI
3604665RX	10461055	95	42MT
3604665RX	10461075	95	42MT
3604665RX	10461096	95	42MT
3604666RX	10459013	13	21SI
3604667RX	10459037	13	21SI
3604668RX	10459051	13	21SI
3604669RX	10459051	13	21SI
3604669RX	19020504	20	27SI
3604671RX	10461044	83	37MT
3604672RX	10461069	83	37MT
3604672RX	10461108	83	37MT
3604673RX	10461058	83	37MT
3604674RX	10459363	39	Ford
3604675RX	10459364	40	Ford Blue Back
3604676RX	10459319	11	20SI
3604677RX	10461486	80	28MT
3604678RX	10459069	20	27SI
3604679RX	10459325	21	30SI
3604680RX	10461056	99	50MT
3604683RX	10459454	50	Motorola
3604684RX	10465530	126	Nippondenso
3604685RX	1117746	21	30SI
3604685RX	10459016	21	30SI
3604685RX	10459057	21	30SI
3604690RX	1109795	99	50MT
3604775RX	19020500	7	10SI
3674143RX	19020544	61	Motorola
3675100RX	10459351	7	10SI
3675101RX	19020500	7	10SI
3675103RX	10459057	21	30SI
3675108RX	10459064	18	25SI and 26SI
3675108RX	10459076	18	25SI and 26SI
3675109RX	10459065	18	25SI and 26SI
3675109RX	10459067	18	25SI and 26SI
3675109RX	10459077	18	25SI and 26SI
3675115RX	10461303	83	37MT
3675115RX	10461084	83	37MT
3675116RX	10461209	83	37MT
3675117RX	10461500	83	37MT
3675121RX	10461089	83	37MT
3675126RX	1117655	11	20SI
3675127RX	10461077	95	42MT
3675128RX	10461078	95	42MT
3675130RX	10461483	80	28MT
3675139RX	19020520	60	Motorola
3675142RX	19020509	57	Motorola
3675144RX	19020543	60	Motorola
3675144RX	19020510	57	Motorola
3675145RX	19020543	60	Motorola
3675145RX	19020510	57	Motorola
3675154RX	10465540	129	Nippondenso
3675155RX	10465541	130	Nippondenso
3675156RX	10459463	13	21SI
3675157RX	10459453	13	21SI
3675158RX	10459336	13	21SI
3675159RX	10459460	13	21SI
3675161RX	10459081	46	JB Series
3675164RX	10461209	84	37MT
3675168RX	10459067	18	25SI and 26SI
3675172RX	10465151	80	28MT

Part Number	Reman Number	Pg	Series
Cummins Recon (cont.)			
3675172RX	10461170	83	37MT
3675172RX	10465151	80	28MT
3675173RX	10465150	80	28MT
3675174RX	10461235	13	21SI
3675201RX	10459461	13	21SI
3675206RX	10465529	125	Nippondenso
3675215RX	10459473	23	33SI
3675222RX	10459360	15	22SI
3675225RX	10459456	15	22SI
3675226RX	10459468	15	22SI
3675229RX	10459472	15	22SI
3675233RX	10459142	23	33SI
3675236RX	10459143	23	33SI
3675245RX	10465537	128	Nippondenso
3675246RX	10465539	129	Nippondenso
3675247RX	10465538	129	Nippondenso
3675248RX	10465534	127	Nippondenso
3675256RX	10459316	10	19SI
3916854RX	10465043	80	28MT
3918376RX	10465365	80	28MT
3675140RX	19020545	61	Motorola
3675141RX	19020546	62	Motorola
3675146RX	19020515	59	Motorola
3675146RX	19020512	58	Motorola
3675148RX	10465438	105	Hitachi
3675149RX	10465437	105	Hitachi
3675150RX	10465444	124	Nippondenso
3675152RX	10465442	123	Nippondenso
3675200RX	10459555	55	Motorola
3675205RX	10465440	123	Nippondenso
Delco Remy			
1100014	10459579	28	Generator
1100015	10459579	28	Generator
1100018	10459579	28	Generator
1100019	10459579	28	Generator
1100020	10459579	28	Generator
1100023	10459579	28	Generator
1100024	10459579	28	Generator
1100028	10459579	28	Generator
1100030	10459579	28	Generator
1100031	10459579	28	Generator
1100072	10463073	19	27SI
1100073	10463072	19	27SI
1100075	10463074	19	27SI
1100076	10463074	19	27SI
1100080	10463072	19	27SI
1100081	10463073	19	27SI
1100082	10463074	19	27SI
1100083	10463074	19	27SI
1100084	10463073	19	27SI
1100086	10463073	19	27SI
1100088	10463074	19	27SI
1100089	10463072	19	27SI
1100090	10463073	19	27SI
1100091	10459238	19	27SI
1100095	10463160	19	27SI
1100096	10463161	19	27SI
1100110	19020501	4	10SI
1100111	19020501	4	10SI
1100113	19020501	4	10SI
1100115	19020501	4	10SI
1100121	19020501	4	10SI
1100122	19020501	4	10SI
1100124	19020501	4	10SI
1100125	19020501	4	10SI

Part Number	Reman Number	Pg	Series
Delco Remy (cont.)			
1100127	19020501	4	10SI
1100129	19020501	4	10SI
1100130	19020501	4	10SI
1100131	19020501	4	10SI
1100132	19020501	4	10SI
1100133	19020501	4	10SI
1100140	19020501	4	10SI
1100141	19020501	4	10SI
1100142	19020501	4	10SI
1100143	19020501	4	10SI
1100145	19020501	4	10SI
1100146	19020501	4	10SI
1100148	19020501	4	10SI
1100149	19020501	4	10SI
1100150	19020501	4	10SI
1100151	19020501	4	10SI
1100152	19020501	4	10SI
1100153	19020501	4	10SI
1100154	19020501	4	10SI
1100155	19020501	4	10SI
1100156	19020501	4	10SI
1100158	19020501	4	10SI
1100159	19020501	4	10SI
1100162	19020501	4	10SI
1100163	19020501	4	10SI
1100164	19020501	4	10SI
1100166	19020501	4	10SI
1100167	19020501	4	10SI
1100168	19020501	4	10SI
1100170	19020501	4	10SI
1100171	19020500	4	10SI
1100174	19020501	4	10SI
1100175	19020501	4	10SI
1100176	19020501	4	10SI
1100179	19020501	4	10SI
1100185	10463073	19	27SI
1100188	10463073	19	27SI
1100189	10463072	19	27SI
1100199	19020501	4	10SI
1100201	19020501	4	10SI
1100202	19020501	4	10SI
1100203	19020501	4	10SI
1100204	19020501	4	10SI
1100211	10459244	19	27SI
1100212	10463073	19	27SI
1100213	10459452	19	27SI
1100214	10463074	19	27SI
1100216	10463161	19	27SI
1100218	19020501	4	10SI
1100221	19020501	4	10SI
1100222	19020501	4	10SI
1100225	19020501	4	10SI
1100226	19020501	4	10SI
1100227	19020501	4	10SI
1100228	19020501	4	10SI
1100229	19020501	4	10SI
1100230	19020501	4	10SI
1100231	19020501	4	10SI
1100232	19020501	4	10SI
1100233	19020501	4	10SI
1100235	19020501	4	10SI
1100236	19020501	4	10SI
1100268	19020501	4	10SI
1100274	10459238	19	27SI
1100305	10459576	28	Generator
1100310	10459580	28	Generator

Part Number	Reman Number	Pg	Series
Delco Remy (cont.)			
1100312	10459580	28	Generator
1100314	10459576	28	Generator
1100315	10459576	28	Generator
1100316	10459576	28	Generator
1100318	10459580	28	Generator
1100320	10459580	28	Generator
1100324	10459580	28	Generator
1100326	10459580	28	Generator
1100328	10459577	28	Generator
1100332	10459576	28	Generator
1100334	10459576	28	Generator
1100335	10459576	28	Generator
1100336	10459580	28	Generator
1100342	10459576	28	Generator
1100348	10459576	28	Generator
1100349	10459576	28	Generator
1100350	10459576	28	Generator
1100352	10459576	28	Generator
1100353	10459577	28	Generator
1100354	10459576	28	Generator
1100355	10459576	28	Generator
1100359	10459577	28	Generator
1100360	10459576	28	Generator
1100362	10459577	28	Generator
1100363	10459576	28	Generator
1100364	10459576	28	Generator
1100365	10459575	28	Generator
1100369	10459576	28	Generator
1100371	10459576	28	Generator
1100374	10459575	28	Generator
1100379	10459577	28	Generator
1100380	10459575	28	Generator
1100384	10459576	28	Generator
1100388	10459576	28	Generator
1100390	10459575	28	Generator
1100394	10459576	28	Generator
1100396	10459576	28	Generator
1100397	10459576	28	Generator
1100398	10459575	28	Generator
1100400	10459576	28	Generator
1100401	10459576	28	Generator
1100407	10459575	28	Generator
1100408	10459576	28	Generator
1100409	10459576	28	Generator
1100410	10459576	28	Generator
1100413	10459575	28	Generator
1100417	10459576	28	Generator
1100419	10459575	28	Generator
1100426	10459576	28	Generator
1100430	10459576	28	Generator
1100431	10459576	28	Generator
1100432	10459577	28	Generator
1100434	10459577	28	Generator
1100435	10459577	28	Generator
1100436	10459576	28	Generator
1100439	10459577	28	Generator
1100441	10459576	28	Generator
1100444	10459575	28	Generator
1100450	10459575	28	Generator
1100487	19020501	4	10SI
1100490	19020500	4	10SI
1100491	19020501	4	10SI
1100491	10459509	8	10SI*
1100493	19020501	4	10SI
1100494	19020501	4	10SI
1100542	19020501	4	10SI

Part Number	Reman Number	Pg	Series
Delco Remy (cont.)			
1100543	19020501	4	10SI
1100544	19020501	4	10SI
1100545	19020501	4	10SI
1100546	19020501	4	10SI
1100547	19020501	4	10SI
1100548	19020501	4	10SI
1100549	19020501	4	10SI
1100552	19020501	4	10SI
1100554	19020501	4	10SI
1100560	19020501	4	10SI
1100573	19020501	4	10SI
1100574	19020501	4	10SI
1100575	19020501	4	10SI
1100578	19020501	4	10SI
1100579	19020501	4	10SI
1100580	19020501	5	10SI
1100581	19020501	5	10SI
1100582	19020501	5	10SI
1100583	19020501	5	10SI
1100584	19020500	5	10SI
1100585	19020500	5	10SI
1100587	19020500	5	10SI
1100588	19020501	5	10SI
1100589	19020501	5	10SI
1100592	19020501	5	10SI
1100593	19020501	5	10SI
1100597	19020501	5	10SI
1100735	10459572	28	Generator
1100773	10459572	28	Generator
1100800	19020501	5	10SI
1100801	19020501	5	10SI
1100809	19020501	5	10SI
1100821	10459572	28	Generator
1100822	10459572	28	Generator
1100825	19020501	5	10SI
1100830	19020501	5	10SI
1100832	19020501	5	10SI
1100833	19020501	5	10SI
1100852	19020501	5	10SI
1100853	19020501	5	10SI
1100854	19020501	5	10SI
1100855	19020501	5	10SI
1100859	19020501	5	10SI
1100880	19020501	5	10SI
1100881	19020501	5	10SI
1100882	19020501	5	10SI
1100884	19020501	5	10SI
1100887	10459572	28	Generator
1100890	19020501	5	10SI
1100897	19020501	5	10SI
1100899	19020501	5	10SI
1100900	19020501	5	10SI
1100901	19020501	5	10SI
1100902	19020501	5	10SI
1100903	19020501	5	10SI
1100904	19020501	5	10SI
1100920	19020501	5	10SI
1100922	19020501	5	10SI
1100923	19020501	5	10SI
1100924	19020501	5	10SI
1100925	19020501	5	10SI
1100926	19020501	5	10SI
1100927	19020501	5	10SI
1100928	19020501	5	10SI
1100930	19020501	5	10SI
1100934	19020501	5	10SI

Part Number	Reman Number	Pg	Series
Delco Remy (cont.)			
1100935	19020501	5	10SI
1100936	19020501	5	10SI
1100937	19020501	5	10SI
1100940	19020501	5	10SI
1100946	19020501	5	10SI
1100947	19020501	5	10SI
1100948	19020501	5	10SI
1100949	19020501	5	10SI
1100950	19020501	5	10SI
1101015	19020504	19	27SI
1101016	19020504	19	27SI
1101018	19020504	19	27SI
1101019	19020504	19	27SI
1101020	19020504	19	27SI
1101021	19020504	19	27SI
1101022	19020504	19	27SI
1101023	19020504	19	27SI
1101025	19020504	19	27SI
1101026	19020504	19	27SI
1101027	19020504	19	27SI
1101028	19020504	19	27SI
1101029	19020504	19	27SI
1101030	19020504	19	27SI
1101032	19020504	19	27SI
1101033	19020504	19	27SI
1101034	19020504	19	27SI
1101035	19020504	19	27SI
1101036	19020504	19	27SI
1101041	19020506	9	15SI
1101043	19020504	19	27SI
1101046	19020504	19	27SI
1101047	19020504	19	27SI
1101048	19020504	19	27SI
1101049	19020504	19	27SI
1101050	19020504	19	27SI
1101058	19020504	19	27SI
1101059	19020504	19	27SI
1101061	19020504	19	27SI
1101062	19020504	19	27SI
1101063	19020504	19	27SI
1101064	19020504	19	27SI
1101073	19020504	19	27SI
1101090	19020504	19	27SI
1101103	10459069	19	27SI
1101104	10463072	19	27SI
1101105	10463073	19	27SI
1101109	19020504	19	27SI
1101155	19020501	5	10SI
1101178	19020504	13	27SI
1101195	19020527	5	10SI
1101204	19020527	5	10SI
1101228	10459348	9	12SI
1101251	10463072	19	27SI
1101268	10459350	9	12SI
1101285	10459343	5	10SI
1101288	10463072	19	27SI
1101289	10463073	19	27SI
1101305	10459339	9	12SI
1101307	19020505	9	12SI
1101308	19020528	9	12SI
1101324	10459339	9	12SI
1101345	10459350	9	12SI
1101449	19020506	9	15SI
1101450	10459069	19	27SI
1101484	19020529	9	12SI
1102001	10459581	28	Generator

Part Number	Reman Number	Pg	Series
Delco Remy (cont.)			
1102898	19020501	5	10SI
1102902	19020501	5	10SI
1102903	19020501	5	10SI
1102904	19020501	5	10SI
1102908	19020501	5	10SI
1102909	19020501	5	10SI
1102914	19020500	5	10SI
1102915	19020501	5	10SI
1102918	19020527	5	10SI
1102922	19020500	5	10SI
1102924	10459509	8	10SI*
1102925	19020521	5	10SI
1102926	19020521	5	10SI
1102927	19020521	5	10SI
1102928	19020521	6	10SI
1102929	19020521	6	10SI
1102930	19020500	6	10SI
1102931	10459509	8	10SI*
1102932	19020500	6	10SI
1102936	19020521	6	10SI
1102937	19020500	6	10SI
1102940	19020521	6	10SI
1102941	19020501	6	10SI
1102955	10459581	30	Generator
1102976	10459581	30	Generator
1103011	10459581	30	Generator
1103026	10459574	30	Generator
1103033	19020501	6	10SI
1103034	19020501	6	10SI
1103035	19020500	6	10SI
1103036	19020501	6	10SI
1103037	19020501	6	10SI
1103044	19020501	6	10SI
1103045	19020501	6	10SI
1103047	19020501	6	10SI
1103054	19020521	6	10SI
1103055	19020501	6	10SI
1103057	19020501	6	10SI
1103058	19020501	6	10SI
1103060	19020501	6	10SI
1103061	19020501	6	10SI
1103063	19020501	6	10SI
1103064	19020501	6	10SI
1103065	19020501	6	10SI
1103066	19020501	6	10SI
1103067	19020501	6	10SI
1103068	19020501	6	10SI
1103069	19020501	6	10SI
1103070	19020501	6	10SI
1103075	19020501	6	10SI
1103076	19020501	6	10SI
1103079	19020501	6	10SI
1103082	19020501	6	10SI
1103084	19020501	6	10SI
1103085	19020501	6	10SI
1103086	19020501	6	10SI
1103088	19020501	6	10SI
1103089	19020501	6	10SI
1103090	19020501	6	10SI
1103091	19020501	6	10SI
1103092	19020501	6	10SI
1103093	19020501	6	10SI
1103094	19020501	6	10SI
1103095	19020501	6	10SI
1103096	19020501	6	10SI
1103097	19020501	6	10SI

Part Number	Reman Number	Pg	Series
Delco Remy (cont.)			
1103100	19020501	6	10SI
1103101	19020501	6	10SI
1103102	19020501	6	10SI
1103103	19020501	6	10SI
1103104	19020501	6	10SI
1103105	19020501	6	10SI
1103106	19020501	6	10SI
1103116	19020521	6	10SI
1103118	19020501	6	10SI
1103122	19020501	6	10SI
1103123	19020527	6	10SI
1103124	19020500	6	10SI
1103125	19020521	6	10SI
1103126	19020521	6	10SI
1103127	19020500	6	10SI
1103128	19020500	6	10SI
1103130	19020521	6	10SI
1103131	19020521	6	10SI
1103133	19020521	6	10SI
1103135	19020521	6	10SI
1103136	10459509	8	10SI*
1103137	10459509	8	10SI*
1103138	19020521	6	10SI
1103140	19020501	6	10SI
1103141	19020500	6	10SI
1103143	19020501	6	10SI
1103144	19020501	6	10SI
1103145	19020501	6	10SI
1103146	19020501	6	10SI
1103147	19020501	6	10SI
1103148	19020501	6	10SI
1103149	19020501	6	10SI
1103151	19020501	6	10SI
1103152	19020501	6	10SI
1103153	19020501	6	10SI
1103154	19020501	6	10SI
1103155	19020501	6	10SI
1103156	19020501	6	10SI
1103157	19020501	6	10SI
1103158	19020501	6	10SI
1103159	19020500	6	10SI
1103160	19020500	6	10SI
1103165	19020500	6	10SI
1103166	19020500	6	10SI
1103169	10459344	6	10SI
1103171	19020521	6	10SI
1103172	19020521	6	10SI
1103173	19020500	6	10SI
1103174	19020521	6	10SI
1103175	19020521	6	10SI
1103182	10459344	6	10SI
1103183	19020521	6	10SI
1103184	19020500	6	10SI
1103186	10459344	6	10SI
1103188	19020501	6	10SI
1103196	19020501	6	10SI
1103197	19020501	6	10SI
1105025	10459339	9	12SI
1105027	10459339	9	12SI
1105028	10459339	9	12SI
1105032	10459350	9	12SI
1105041	10459339	9	12SI
1105042	10459339	9	12SI
1105043	10459344	6	10SI
1105050	10459344	6	10SI
1105066	19020521	6	10SI

Part Number	Reman Number	Pg	Series
Delco Remy (cont.)			
1105067	19020501	6	10SI
1105068	19020500	6	10SI
1105069	19020500	6	10SI
1105070	19020521	6	10SI
1105072	19020521	6	10SI
1105073	19020500	6	10SI
1105074	19020521	6	10SI
1105079	19020501	7	10SI
1105080	19020501	7	10SI
1105098	19020500	7	10SI
1105160	19020521	7	10SI
1105161	19020500	7	10SI
1105161	10459509	8	10SI*
1105162	19020521	7	10SI
1105163	19020521	7	10SI
1105164	19020521	7	10SI
1105165	19020521	7	10SI
1105166	19020521	7	10SI
1105167	19020521	7	10SI
1105168	19020521	7	10SI
1105169	19020521	7	10SI
1105170	19020521	7	10SI
1105171	19020521	7	10SI
1105172	19020500	7	10SI
1105173	19020500	7	10SI
1105174	19020500	7	10SI
1105175	19020500	7	10SI
1105176	19020500	7	10SI
1105177	19020500	7	10SI
1105178	19020500	7	10SI
1105179	19020527	7	10SI
1105186	19020506	9	15SI
1105197	19020506	9	15SI
1105250	19020506	9	15SI
1105332	19020506	9	15SI
1105335	19020506	9	15SI
1105351	19020501	3	10SI
1105360	19020501	7	10SI
1105363	19020501	7	10SI
1105369	10459339	9	12SI
1105370	10459350	9	12SI
1105402	10459338	9	12SI
1105419	19020527	7	10SI
1105420	19020521	7	10SI
1105421	19020500	7	10SI
1105422	19020521	7	10SI
1105423	19020500	7	10SI
1105424	19020521	7	10SI
1105428	10459338	9	12SI
1105429	19020521	7	10SI
1105431	19020525	7	10SI
1105434	19020500	7	10SI
1105436	19020525	7	10SI
1105455	10459509	8	10SI*
1105456	10459365	7	10SI
1105456	10459509	8	10SI*
1105457	10459509	8	10SI*
1105459	19020526	7	10SI
1105460	10463073	19	27SI
1105461	10463074	19	27SI
1105463	10463073	19	27SI
1105464	10463073	19	27SI
1105465	10463072	19	27SI
1105466	10463074	19	27SI
1105469	10463072	19	27SI
1105470	10463072	19	27SI

INTERCHANGE



Part Number	Reman Number	Pg	Series
Delco Remy (cont.)			
1105471	10463074	19	27SI
1105472	10459238	19	27SI
1105473	10459238	19	27SI
1105474	10459244	20	27SI
1105475	10459244	20	27SI
1105476	10459244	20	27SI
1105477	10459452	20	27SI
1105480	10459339	9	12SI
1105493	10459339	9	12SI
1105510	19020527	7	10SI
1105512	19020506	9	15SI
1105514	19020521	7	10SI
1105516	10459350	9	12SI
1105517	10459350	9	12SI
1105536	10459367	9	15SI
1105558	19020521	7	10SI
1105559	19020500	7	10SI
1105560	10459366	10	15SI
1105561	10459339	9	12SI
1105562	10459339	9	12SI
1105564	10459339	9	12SI
1105573	19020521	7	10SI
1105574	19020500	7	10SI
1105577	19020504	20	27SI
1105578	19020504	20	27SI
1105584	19020521	7	10SI
1105586	10459351	7	10SI
1105619	19020500	7	10SI
1105645	19020500	7	10SI
1105649	19020501	7	10SI
1105686	19020521	7	10SI
1107001	10461700	74	10MT
1107009	10461700	74	10MT
1107033	10461700	74	10MT
1107047	10461700	74	10MT
1107054	10461700	74	10MT
1107055	10461700	74	10MT
1107061	10461700	74	10MT
1107103	10461700	74	10MT
1107108	10461700	74	10MT
1107204	10461606	74	10MT
1107215	10461612	74	10MT
1107226	10461649	74	10MT
1107227	10461701	74	10MT
1107245	10461597	74	10MT
1107249	10461617	74	10MT
1107295	10461606	74	10MT
1107300	10461611	74	10MT
1107308	10461603	74	10MT
1107350	10461613	74	10MT
1107356	10461669	74	10MT
1107377	10461605	74	10MT
1107378	10461605	74	10MT
1107382	10461611	74	10MT
1107386	10461599	74	10MT
1107398	10465060	74	10MT
1107399	10461600	74	10MT
1107427	10461696	74	10MT
1107448	10461696	74	10MT
1107512	10461598	77	20, 22, 25MT
1107522	10461615	77	20, 22, 25MT
1107546	10461615	77	20, 22, 25MT
1107550	10461697	77	20, 22, 25MT
1107557	10461616	77	20, 22, 25MT
1107577	10461443	79	28MT
1107578	10461615	77	20, 22, 25MT

Part Number	Reman Number	Pg	Series
Delco Remy (cont.)			
1107582	10461616	77	20, 22, 25MT
1107583	10461598	77	20, 22, 25MT
1107599	10461443	79	28MT
1107627	10461625	74	10MT
1107640	10461625	74	10MT
1107645	10461625	74	10MT
1107649	10461625	74	10MT
1107654	10465158	74	10MT
1107670	10461625	74	10MT
1107678	10461624	74	10MT
1107679	10461624	74	10MT
1107695	10461668	74	10MT
1107726	10461649	74	10MT
1107758	10461671	74	10MT
1107782	10461602	77	20, 22, 25MT
1107785	10461613	74	10MT
1107853	10461598	77	20, 22, 25MT
1107860	10461598	77	20, 22, 25MT
1107863	10461443	79	28MT
1107870	10461598	77	20, 22, 25MT
1107871	10461443	79	28MT
1107885	10461612	74	10MT
1108251	10461697	77	20, 22, 25MT
1108284	10461620	74	10MT
1108290	10461612	74	10MT
1108319	10461600	74	10MT
1108388	10461617	74	10MT
1108390	10461620	74	10MT
1108394	10461677	74	10MT
1108421	10461613	74	10MT
1108423	10461606	74	10MT
1108438	10461613	74	10MT
1108494	10461613	74	10MT
1108508	10461603	74	10MT
1108665	10461615	77	20, 22, 25MT
1108675	10461615	77	20, 22, 25MT
1108769	10465158	74	10MT
1108857	10461047	86	40MT
1108858	10461047	86	40MT
1108863	10461047	86	40MT
1108873	10461047	86	40MT
1109053	10461597	75	10MT
1109055	10465060	75	10MT
1109085	10465060	75	10MT
1109086	10461597	75	10MT
1109087	10461603	75	10MT
1109090	10461605	75	10MT
1109091	10461605	75	10MT
1109095	10461606	75	10MT
1109143	10461609	77	20, 22, 25MT
1109145	10461615	77	20, 22, 25MT
1109149	10461610	77	20, 22, 25MT
1109190	10461610	77	20, 22, 25MT
1109222	10461057	97	50MT
1109251	10461678	77	20, 22, 25MT
1109256	10461698	77	20, 22, 25MT
1109273	1109555	97	50MT
1109279	10461159	97	50MT
1109280	10461159	97	50MT
1109284	10461160	97	50MT
1109285	10461057	97	50MT
1109286	10461057	97	50MT
1109287	10461057	97	50MT
1109288	10461057	97	50MT
1109289	10461057	97	50MT
1109290	10461057	97	50MT

Part Number	Reman Number	Pg	Series
Delco Remy (cont.)			
1109291	10461057	97	50MT
1109292	10461057	97	50MT
1109293	10461057	97	50MT
1109294	1109793	97	50MT
1109295	10461056	97	50MT
1109296	10461057	97	50MT
1109297	10461499	97	50MT
1109298	10461057	97	50MT
1109420	10461617	75	10MT
1109421	10461600	75	10MT
1109424	10461599	75	10MT
1109426	10461602	77	20, 22, 25MT
1109436	10461611	75	10MT
1109438	10461612	75	10MT
1109457	10461661	75	10MT
1109493	10461382	97	50MT
1109494	10461057	97	50MT
1109496	10465315	79	28MT
1109497	1109555	97	50MT
1109545	10461056	97	50MT
1109550	10496881	78	27MT
1109553	10461057	97	50MT
1109554	10461056	97	50MT
1109555	1109555	97	50MT
1109576	10461600	75	10MT
1109624	1109795	97	50MT
1109625	10461161	97	50MT
1109628	1109795	97	50MT
1109629	10461160	97	50MT
1109630	10461382	97	50MT
1109631	10461057	97	50MT
1109632	1109555	97	50MT
1109633	1109793	97	50MT
1109634	1109795	97	50MT
1109636	10461057	97	50MT
1109637	1109795	97	50MT
1109638	10461057	97	50MT
1109640	1109795	97	50MT
1109641	10461737	97	50MT
1109641	10461735	97	50MT
1109641	1109793	97	50MT
1109642	10461057	97	50MT
1109643	10461057	97	50MT
1109644	1109793	97	50MT
1109645	1109795	97	50MT
1109646	10461382	97	50MT
1109647	10461057	97	50MT
1109648	10461499	97	50MT
1109649	10461057	97	50MT
1109755	10461057	97	50MT
1109756	1109793	97	50MT
1109757	1109792	97	50MT
1109758	10461167	97	50MT
1109759	10461057	97	50MT
1109768	10461057	97	50MT
1109770	1109792	98	50MT
1109771	10461057	98	50MT
1109772	10461057	98	50MT
1109773	10461057	98	50MT
1109774	10461057	98	50MT
1109775	10461057	98	50MT
1109776	10461057	98	50MT
1109777	10461057	98	50MT
1109778	10461057	98	50MT
1109780	10461057	98	50MT
1109781	10461732	98	50MT

INTERCHANGE

Part Number	Reman Number	Pg	Series
Delco Remy (cont.)			
1109781	1109555	98	50MT
1109782	10461057	98	50MT
1109787	10461057	98	50MT
1109788	1109555	98	50MT
1109789	1109555	98	50MT
1109790	10461731	98	50MT
1109790	10461056	98	50MT
1109791	10461057	98	50MT
1109792	10461734	98	50MT
1109792	1109792	97	50MT
1109793	1109793	97	50MT
1109795	1109795	97	50MT
1109796	10461161	98	50MT
1109797	10461159	98	50MT
1109798	10461382	98	50MT
1109799	10461499	98	50MT
1109830	10461499	98	50MT
1109831	10461057	98	50MT
1109833	1109555	98	50MT
1109834	1109555	98	50MT
1109835	1109793	98	50MT
1109836	1109555	98	50MT
1109837	10461382	98	50MT
1109838	10461057	98	50MT
1109839	10461057	98	50MT
1109840	10461057	98	50MT
1109841	10461057	98	50MT
1109842	10461057	98	50MT
1109843	10461057	98	50MT
1109844	10461382	98	50MT
1109845	10461057	98	50MT
1109846	10461057	98	50MT
1109847	1109795	98	50MT
1109848	1109795	98	50MT
1109849	1109792	98	50MT
1109854	10461047	86	40MT
1109862	10461047	86	40MT
1109874	10461047	86	40MT
1109884	10461159	98	50MT
1109961	10461057	98	50MT
1109962	10461499	98	50MT
1109963	10461159	98	50MT
1109965	10461057	98	50MT
1109971	10461733	98	50MT
1109979	10461739	98	50MT
1109969	1109793	98	50MT
1109971	10461382	98	50MT
1109972	10461057	98	50MT
1109973	10461057	98	50MT
1109977	10461057	98	50MT
1109978	10461057	98	50MT
1109979	10461057	98	50MT
1109984	10461159	98	50MT
1109986	10461057	98	50MT
1109987	10461057	98	50MT
1109997	1109793	98	50MT
1109998	1109795	98	50MT
1113089	10461089	82	37MT
1113266	10465296	79	28MT
1113267	10465168	79	28MT
1113269	10465296	79	28MT
1113270	10465168	79	28MT
1113271	10461443	79	28MT
1113272	10461444	79	28MT
1113273	10461445	79	28MT
1113274	10465295	79	28MT

Part Number	Reman Number	Pg	Series
Delco Remy (cont.)			
1113275	New Serv.	143	28MT
1113275	10461446	79	28MT
1113276	New Serv.	143	28MT
1113276	10465043	79	28MT
1113277	New Serv.	143	28MT
1113277	10461468	79	28MT
1113278	10461447	79	28MT
1113279	10461448	79	28MT
1113280	10461449	79	28MT
1113281	10461450	79	28MT
1113282	10461451	79	28MT
1113283	10461482	79	28MT
1113284	10461483	79	28MT
1113285	10465349	79	28MT
1113286	10465315	79	28MT
1113287	10461452	79	28MT
1113288	10461484	79	28MT
1113289	10465239	79	28MT
1113291	10461486	79	28MT
1113292	New Serv.	143	28MT
1113292	10465365	79	28MT
1113295	10465296	79	28MT
1113296	New Serv.	143	28MT
1113296	10465168	79	28MT
1113297	10461487	79	28MT
1113593	10465149	78	27MT
1113706	10461047	86	40MT
1113707	10461047	86	40MT
1113708	10461047	86	40MT
1113710	10461047	86	40MT
1113783	10461047	86	40MT
1113814	10461047	86	40MT
1113818	10461047	86	40MT
1113824	10461047	86	40MT
1113825	10461047	86	40MT
1113831	10461047	86	40MT
1113842	10461047	86	40MT
1113844	1114786	86	40MT
1113845	10461047	86	40MT
1113846	10461047	86	40MT
1113849	10461047	86	40MT
1113850	10461047	86	40MT
1113851	10461047	86	40MT
1113855	10461047	86	40MT
1113856	1990210	86	40MT
1113857	1990210	86	40MT
1113858	10461047	86	40MT
1113861	10461047	86	40MT
1113862	10461047	86	40MT
1113865	1114786	86	40MT
1113866	10461047	86	40MT
1113869	1114786	86	40MT
1113872	10461047	86	40MT
1113874	1990210	86	40MT
1113875	1990210	86	40MT
1113876	10461047	86	40MT
1113877	1114786	86	40MT
1113878	1114786	86	40MT
1113883	10461047	86	40MT
1113884	1114786	86	40MT
1113887	10461047	86	40MT
1113895	10461047	86	40MT
1113898	10461047	86	40MT
1113899	1114786	86	40MT
1113900	10461047	86	40MT
1113905	10461047	86	40MT

Part Number	Reman Number	Pg	Series
Delco Remy (cont.)			
1113907	1990210	86	40MT
1113908	1114786	86	40MT
1113909	1114786	86	40MT
1113911	1114786	86	40MT
1113914	10461047	86	40MT
1113915	10461047	86	40MT
1113916	10461047	86	40MT
1113920	10461047	86	40MT
1113924	10461047	86	40MT
1113926	10461047	86	40MT
1113931	10461045	86	40MT
1113935	10461047	86	40MT
1113952	10461047	86	40MT
1113954	1114786	86	40MT
1113955	10461047	86	40MT
1113957	10461047	86	40MT
1113965	10461047	86	40MT
1113966	10461047	86	40MT
1113968	10461047	86	40MT
1113972	10461047	86	40MT
1113973	10461047	86	40MT
1113975	10461047	86	40MT
1113976	10461047	86	40MT
1113977	10461047	86	40MT
1113979	1114786	86	40MT
1113980	10461047	86	40MT
1113983	10461047	86	40MT
1113991	10461047	86	40MT
1113993	10461107	87	40MT
1113997	10461047	87	40MT
1113999	10461047	87	40MT
1114046	10461073	87	40MT
1114052	10461059	87	40MT
1114055	10461045	87	40MT
1114056	10461045	87	40MT
1114058	10461045	87	40MT
1114064	10461045	87	40MT
1114070	10461073	87	40MT
1114071	10461073	87	40MT
1114072	10461045	87	40MT
1114074	10461045	87	40MT
1114076	10461045	87	40MT
1114077	10461059	87	40MT
1114078	10461045	87	40MT
1114081	10461045	87	40MT
1114084	10461045	87	40MT
1114085	10461073	87	40MT
1114086	10461045	87	40MT
1114087	10461045	87	40MT
1114088	10461045	87	40MT
1114090	10461045	87	40MT
1114092	10461045	87	40MT
1114095	10461045	87	40MT
1114096	10461045	87	40MT
1114098	10461045	87	40MT
1114100	10461071	87	40MT
1114101	10461059	87	40MT
1114102	10461045	87	40MT
1114105	10461073	87	40MT
1114107	10461045	87	40MT
1114109	10461046	87	40MT
1114110	10461046	87	40MT
1114111	10461045	87	40MT
1114112	1990220	87	40MT
1114113	10461045	87	40MT
1114114	10461046	87	40MT

INTERCHANGE



Part Number	Reman Number	Pg	Series
Delco Remy (cont.)			
1114115	10461045	87	40MT
1114117	10461046	87	40MT
1114119	10461045	87	40MT
1114120	1990220	87	40MT
1114121	1990220	87	40MT
1114122	10461045	87	40MT
1114124	10461045	87	40MT
1114126	10461045	87	40MT
1114127	10461046	87	40MT
1114128	10461045	87	40MT
1114129	10461046	87	40MT
1114130	10461045	87	40MT
1114133	10461045	87	40MT
1114135	10461073	87	40MT
1114136	10461046	87	40MT
1114137	10461073	87	40MT
1114138	10461046	87	40MT
1114139	10461046	87	40MT
1114140	10461045	87	40MT
1114141	10461046	87	40MT
1114143	10461045	87	40MT
1114144	10461046	87	40MT
1114145	10461045	87	40MT
1114146	10461059	87	40MT
1114147	10461073	87	40MT
1114148	10461045	87	40MT
1114149	10461046	87	40MT
1114150	10461045	87	40MT
1114151	10461046	87	40MT
1114152	1990220	87	40MT
1114153	10461046	87	40MT
1114154	10461059	87	40MT
1114156	10461046	87	40MT
1114157	10461045	87	40MT
1114158	10461046	87	40MT
1114161	10461073	87	40MT
1114162	10461046	87	40MT
1114163	10461073	87	40MT
1114164	10461045	87	40MT
1114165	10461045	87	40MT
1114166	1990220	87	40MT
1114167	10461046	87	40MT
1114168	10461059	87	40MT
1114169	10461046	87	40MT
1114170	10461045	87	40MT
1114171	1990220	87	40MT
1114172	10461045	87	40MT
1114175	10461046	87	40MT
1114176	10461073	87	40MT
1114178	10461073	87	40MT
1114180	10461045	87	40MT
1114187	10461045	87	40MT
1114188	10461045	87	40MT
1114189	10461045	87	40MT
1114190	10461046	87	40MT
1114191	1990220	87	40MT
1114192	1990220	87	40MT
1114193	10461045	87	40MT
1114194	10461045	87	40MT
1114197	10461045	87	40MT
1114198	1990220	87	40MT
1114199	10461046	87	40MT
1114532	New Serv.	148	Magnetic Switch
1114534	New Serv.	148	Magnetic Switch
1114536	New Serv.	148	Magnetic Switch
1114537	New Serv.	148	Magnetic Switch

Part Number	Reman Number	Pg	Series
Delco Remy (cont.)			
1114538	New Serv.	148	Magnetic Switch
1114540	New Serv.	148	Magnetic Switch
1114543	New Serv.	148	Magnetic Switch
1114545	New Serv.	148	Magnetic Switch
1114547	New Serv.	148	Magnetic Switch
1114548	New Serv.	148	Magnetic Switch
1114549	New Serv.	148	Magnetic Switch
1114705	10461046	86	40MT
1114708	10461046	87	40MT
1114709	1990220	87	40MT
1114710	10461047	87	40MT
1114714	10461046	87	40MT
1114715	10461047	87	40MT
1114719	1114786	87	40MT
1114720	10461045	87	40MT
1114722	10461045	87	40MT
1114723	10461045	87	40MT
1114724	10461046	87	40MT
1114725	10461045	87	40MT
1114726	10461045	88	40MT
1114727	10461047	88	40MT
1114728	10461047	88	40MT
1114733	1990220	88	40MT
1114734	10461060	88	40MT
1114736	10461071	88	40MT
1114737	10461047	88	40MT
1114738	10461047	88	40MT
1114739	1990210	88	40MT
1114741	10461045	88	40MT
1114744	1990220	88	40MT
1114745	10461060	88	40MT
1114746	1990220	88	40MT
1114747	10461045	88	40MT
1114748	10461046	88	40MT
1114749	10461045	88	40MT
1114750	10461045	88	40MT
1114751	10461045	88	40MT
1114752	10461045	88	40MT
1114753	10461046	88	40MT
1114754	10461046	88	40MT
1114755	10461047	88	40MT
1114756	10461047	88	40MT
1114757	10461073	88	40MT
1114758	10461073	88	40MT
1114761	10461045	88	40MT
1114763	1114786	88	40MT
1114769	10461045	88	40MT
1114770	10461059	88	40MT
1114771	10461059	88	40MT
1114775	10461059	88	40MT
1114776	10461107	88	40MT
1114778	10461071	88	40MT
1114786	1114786	86	40MT
1114787	10461060	88	40MT
1114789	10461059	88	40MT
1114790	10461047	88	40MT
1114791	10461045	88	40MT
1114796	10461059	88	40MT
1114799	10461045	88	40MT
1114810	10461073	88	40MT
1114812	10461045	88	40MT
1114813	10461045	88	40MT
1114814	10461045	88	40MT
1114815	10461045	88	40MT
1114816	10461045	88	40MT
1114817	10461073	88	40MT

Part Number	Reman Number	Pg	Series
Delco Remy (cont.)			
1114818	10461073	88	40MT
1114819	10461045	88	40MT
1114820	10461045	88	40MT
1114823	10461046	88	40MT
1114824	10461046	88	40MT
1114825	10461046	88	40MT
1114826	1990220	88	40MT
1114827	10461046	88	40MT
1114828	10461046	88	40MT
1114829	1990220	88	40MT
1114830	1990220	88	40MT
1114831	10461107	88	40MT
1114832	10461046	88	40MT
1114833	1990220	88	40MT
1114834	10461046	88	40MT
1114835	10461046	88	40MT
1114839	10461059	88	40MT
1114840	1990210	88	40MT
1114842	10461047	88	40MT
1114843	10461107	88	40MT
1114844	10461047	88	40MT
1114846	10461047	88	40MT
1114847	10461047	88	40MT
1114848	10461047	88	40MT
1114849	10461047	88	40MT
1114850	10461047	88	40MT
1114851	10461047	88	40MT
1114852	10461047	88	40MT
1114853	10461047	88	40MT
1114854	10461047	88	40MT
1114855	10461047	88	40MT
1114859	10461107	88	40MT
1114866	1114786	88	40MT
1114867	1114786	88	40MT
1114868	1114786	88	40MT
1114873	10461047	88	40MT
1114874	10461047	86	40MT
1114875	10461047	88	40MT
1114878	10461047	88	40MT
1114879	10461047	88	40MT
1114880	10461047	88	40MT
1114881	1990220	88	40MT
1114882	10461046	88	40MT
1114883	10461046	88	40MT
1114884	10461060	88	40MT
1114885	10461046	88	40MT
1114886	10461060	88	40MT
1114887	1990220	88	40MT
1114888	10461046	88	40MT
1114889	10461045	88	40MT
1114890	10461045	88	40MT
1114891	10461045	88	40MT
1114892	10461045	88	40MT
1114893	10461045	88	40MT
1114894	10461045	88	40MT
1114895	10461045	88	40MT
1114896	10461045	88	40MT
1114897	10461045	88	40MT
1114898	10461045	88	40MT
1114899	10461045	88	40MT
1114900	10461045	88	40MT
1114901	10461045	88	40MT
1114902	10461071	88	40MT
1114903	10461047	88	40MT
1114904	10461059	88	40MT
1114905	10461107	88	40MT

Part Number	Reman Number	Pg	Series
Delco Remy (cont.)			
1114906	10461045	89	40MT
1114907	10461047	89	40MT
1114909	10461047	89	40MT
1114911	10461046	89	40MT
1114913	10461045	89	40MT
1114915	10461047	89	40MT
1114920	10461059	89	40MT
1114922	1990210	89	40MT
1114923	10461047	89	40MT
1114924	1114786	89	40MT
1114927	10461059	89	40MT
1114928	10461045	89	40MT
1114932	10461073	89	40MT
1114933	10461046	89	40MT
1114934	10461059	89	40MT
1114935	10461047	89	40MT
1114936	10461059	89	40MT
1114937	10461045	89	40MT
1114938	10461067	89	40MT
1114939	10461067	89	40MT
1114941	10461045	89	40MT
1114944	10461059	89	40MT
1114946	10461045	89	40MT
1114947	10461047	89	40MT
1114950	10461047	89	40MT
1114951	10461047	89	40MT
1114952	1990210	89	40MT
1114958	10461047	89	40MT
1114961	10461045	89	40MT
1114963	10461047	89	40MT
1114964	10461047	89	40MT
1114966	1990220	89	40MT
1114967	10461046	89	40MT
1114970	10461047	89	40MT
1114977	10461060	89	40MT
1114978	10461045	89	40MT
1114979	10461047	89	40MT
1114981	10461047	89	40MT
1114983	10461045	89	40MT
1114984	10461045	89	40MT
1114985	10461045	89	40MT
1114986	10461046	89	40MT
1114987	10461047	89	40MT
1114988	10461073	89	40MT
1114989	10461107	89	40MT
1114997	10461073	89	40MT
1114998	1990210	89	40MT
1115502	10456390	133	Solenoid
1115544	10456391	133	Solenoid
1115548	10456391	133	Solenoid
1115556	10456390	133	Solenoid
1115557	10456391	133	Solenoid
1115559	10456391	133	Solenoid
1115592	New Serv.	148	Magnetic Switch
1115593	New Serv.	142	Solenoid
1115593	10512653	134	Solenoid
1115593	1115701	147	SSL
1115593	New Serv.	142	SSL
1115595	1115673	142	Solenoid
1115595	1115673	147	SSL
1115597	10511217	147	SSL
1115598	New Serv.	142	Solenoid
1115598	10511210	147	SSL
1115601	10511219	147	SSL

Part Number	Reman Number	Pg	Series
Delco Remy (cont.)			
1115602	10511214	147	SSL
1115609	New Serv.	142	Solenoid
1115609	10456392	133	Solenoid
1115609	1115689	147	SSL
1115610	New Serv.	142	Solenoid
1115610	1115690	147	SSL
1115611	10456393	133	Solenoid
1115611	1115689	147	SSL
1115615	New Serv.	148	Magnetic Switch
1115616	New Serv.	148	Magnetic Switch
1115617	1115693	147	SSL
1115618	1115694	147	SSL
1115618	New Serv.	142	Solenoid
1115619	1115675	147	SSL
1115621	New Serv.	142	Solenoid
1115621	1115680	147	SSL
1115622	New Serv.	142	Solenoid
1115622	1115674	147	SSL
1115623	1115695	147	SSL
1115624	10511213	147	SSL
1115624	New Serv.	142	Solenoid
1115625	1115563	147	SSL
1115627	New Serv.	142	Solenoid
1115627	1115676	147	SSL
1115628	1115697	147	SSL
1115633	1115673	147	SSL
1115633	10511215	147	SSL
1115634	1115682	147	SSL
1115636	New Serv.	148	Magnetic Switch
1115638	New Serv.	142	Solenoid
1115638	1115701	147	SSL
1115639	1115702	147	SSL
1115639	New Serv.	142	Solenoid
1115640	New Serv.	142	Solenoid
1115640	1115678	147	SSL
1115641	New Serv.	142	Solenoid
1115641	1115673	147	SSL
1115642	10511211	147	SSL
1115643	1115704	147	SSL
1115652	1115672	147	SSL
1115653	1115706	147	SSL
1115655	1115677	147	SSL
1115656	10511212	147	SSL
1115657	1115683	147	SSL
1115667	1115673	147	SSL
1115668	1115673	147	SSL
1115671	1115673	147	SSL
1115672	New Serv.	142	Solenoid
1115673	1115673	147	SSL
1115682	New Serv.	142	Solenoid
1115683	New Serv.	142	Solenoid
1115687	10511210	147	SSL
1115688	10512653	134	SSL
1115689	1115689	147	SSL
1115690	1115689	147	SSL
1115693	New Serv.	142	Solenoid
1115693	1115689	147	SSL
1115694	1115689	147	SSL
1115695	New Serv.	142	Solenoid
1115695	1115689	147	SSL
1115696	1115689	147	SSL
1115697	1115689	147	SSL
1115700	10511210	147	SSL
1115703	10512653	134	SSL
1115704	New Serv.	142	Solenoid
1115704	1115689	147	SSL

Part Number	Reman Number	Pg	Series
Delco Remy (cont.)			
1115706	New Serv.	142	Solenoid
1115707	10512653	134	SSL
1115712	10512653	134	SSL
1117067	10459009	21	30SI
1117068	10459009	21	30SI
1117069	10459076	17	25SI and 26SI
1117167	10459123	26	50DN Belt Drive
1117224	10459064	17	25SI and 26SI
1117225	10459077	17	25SI and 26SI
1117226	10459064	17	25SI and 26SI
1117227	10459077	17	25SI and 26SI
1117228	10459077	17	25SI and 26SI
1117231	10459077	17	25SI and 26SI
1117234	10459077	17	25SI and 26SI
1117236	10459064	17	25SI and 26SI
1117238	10459076	17	25SI and 26SI
1117239	10459064	17	25SI and 26SI
1117240	10459077	17	25SI and 26SI
1117241	10459077	17	25SI and 26SI
1117242	10459077	17	25SI and 26SI
1117243	10459064	17	25SI and 26SI
1117244	10459077	17	25SI and 26SI
1117248	10459064	17	25SI and 26SI
1117249	10459076	17	25SI and 26SI
1117250	10459064	17	25SI and 26SI
1117251	10459077	17	25SI and 26SI
1117253	10459064	17	25SI and 26SI
1117254	10459245	17	25SI and 26SI
1117255	10459077	17	25SI and 26SI
1117256	10459076	17	25SI and 26SI
1117258	10459064	17	25SI and 26SI
1117259	10459077	17	25SI and 26SI
1117260	10459077	17	25SI and 26SI
1117261	10459077	17	25SI and 26SI
1117262	10459077	17	25SI and 26SI
1117263	10459077	17	25SI and 26SI
1117264	10459065	17	25SI and 26SI
1117265	10459065	17	25SI and 26SI
1117266	10459065	17	25SI and 26SI
1117267	10459077	17	25SI and 26SI
1117268	10459065	17	25SI and 26SI
1117269	10459065	17	25SI and 26SI
1117270	10459065	17	25SI and 26SI
1117272	10459065	17	25SI and 26SI
1117273	10459065	17	25SI and 26SI
1117274	10459067	17	25SI and 26SI
1117279	10459066	17	25SI and 26SI
1117281	10459076	17	25SI and 26SI
1117282	10459064	17	25SI and 26SI
1117481	10459009	21	30SI
1117482	10459010	21	30SI
1117483	10459009	21	30SI
1117484	10459009	21	30SI
1117485	10459009	21	30SI
1117611	10459252	10	20SI
1117612	10459252	10	20SI
1117614	10459319	10	20SI
1117615	10459319	10	20SI
1117616	10459252	10	20SI
1117618	10459252	11	20SI
1117619	10459319	11	20SI
1117620	10459020	11	20SI
1117621	10459020	11	20SI
1117622	10459319	11	20SI
1117623	1117655	11	20SI
1117624	10459252	11	20SI

INTERCHANGE



Part Number	Reman Number	Pg	Series
Delco Remy (cont.)			
1117628	10459020	11	20SI
1117631	1117655	11	20SI
1117640	1117655	11	20SI
1117641	10459020	11	20SI
1117642	10459319	11	20SI
1117643	10459319	11	20SI
1117644	1117655	11	20SI
1117645	10459319	11	20SI
1117647	1117655	11	20SI
1117648	1117746	21	30SI
1117655	1117655	11	20SI
1117689	10459124	27	50DN Gear Drive
1117690	10459297	27	50DN Gear Drive
1117692	10459124	27	50DN Gear Drive
1117695	10459124	27	50DN Gear Drive
1117698	10459124	27	50DN Gear Drive
1117700	10459124	27	50DN Gear Drive
1117707	10459123	26	50DN Belt Drive
1117708	10459123	26	50DN Belt Drive
1117732	10459008	21	30SI
1117733	10459325	21	30SI
1117734	1117746	21	30SI
1117735	10459016	21	30SI
1117736	10459008	21	30SI
1117738	10459246	21	30SI
1117739	10459123	26	50DN Belt Drive
1117746	1117746	21	30SI
1117753	10459246	21	30SI
1117754	10459246	21	30SI
1117772	1117746	21	30SI
1117792	10459124	27	50DN Gear Drive
1117794	10459124	27	50DN Gear Drive
1117799	10459123	26	50DN Belt Drive
1117800	10459008	21	30SI
1117801	10459008	21	30SI
1117803	10459008	21	30SI
1117804	10459008	21	30SI
1117805	10459057	21	30SI
1117806	10459259	21	30SI
1117807	10459368	21	30SI
1117808	10459008	21	30SI
1117809	10459258	21	30SI
1117811	10459008	21	30SI
1117812	10459008	21	30SI
1117813	10459008	21	30SI
1117814	10459009	21	30SI
1117815	10459004	21	30SI
1117816	10459008	21	30SI
1117817	10459120	21	30SI
1117818	10459079	21	30SI
1117820	10459097	21	30SI
1117822	10459259	21	30SI
1117823	10459259	21	30SI
1117826	1117746	21	30SI
1117830	10459097	21	30SI
1117831	10459057	21	30SI
1117852	10459123	26	50DN Belt Drive
1117853	10459123	26	50DN Belt Drive
1117854	10459298	27	50DN Gear Drive
1117855	10459297	27	50DN Gear Drive
1117860	10459299	26	50DN Belt Drive
1117861	10459121	27	50DN Gear Drive
1117862	10459122	27	50DN Gear Drive
1117863	10459123	26	50DN Belt Drive
1117864	10459123	26	50DN Belt Drive
1117866	10459121	27	50DN Gear Drive

Part Number	Reman Number	Pg	Series
Delco Remy (cont.)			
1117867	10459122	27	50DN Gear Drive
1117877	10459299	26	50DN Belt Drive
1117878	10459123	26	50DN Belt Drive
1117879	10459123	26	50DN Belt Drive
1117880	10459013	11	21SI
1117885	10459013	11	21SI
1117886	10459013	11	21SI
1117887	10459013	11	21SI
1117889	10459013	11	21SI
1117890	10459013	11	21SI
1117891	10459037	11	21SI
1117892	10459013	11	21SI
1117893	10459037	11	21SI
1117894	10459013	11	21SI
1117896	10459453	11	21SI
1117898	10459547	11	21SI
1117899	10459457	11	21SI
1117900	10461235	11	21SI
1117903	10459046	11	21SI
1117904	10459453	11	21SI
1117905	10459013	11	21SI
1117906	10459037	11	21SI
1117907	10459046	12	21SI
1117908	10459453	12	21SI
1117909	10459037	12	21SI
1117910	10459037	12	21SI
1117911	10459037	12	21SI
1117914	10459037	12	21SI
1117916	10459051	12	21SI
1117918	10459037	12	21SI
1117921	10459051	12	21SI
1117923	10459037	12	21SI
1117925	10459013	12	21SI
1117926	10459460	12	21SI
1117927	10459046	12	21SI
1117928	10459453	12	21SI
1117929	10459037	12	21SI
1117930	10459013	12	21SI
1117931	10459013	12	21SI
1117932	10459037	12	21SI
1117933	10459051	12	21SI
1117937	10459013	12	21SI
1117938	10459457	12	21SI
1117941	10459037	12	21SI
1117942	10459013	12	21SI
1117943	10459037	12	21SI
1117946	10459037	12	21SI
1117947	10459037	12	21SI
1117948	10459051	12	21SI
1117949	10459037	12	21SI
1117950	10459013	12	21SI
1117951	10459037	12	21SI
1117952	10459051	12	21SI
1117953	10459013	12	21SI
1117954	10459013	12	21SI
1117955	10459013	12	21SI
1117956	10459013	12	21SI
1117957	10459037	12	21SI
1117958	10459037	12	21SI
1117959	10459037	12	21SI
1117960	10459013	12	21SI
1117961	10459037	12	21SI
1117962	10459037	12	21SI
1117963	10459037	12	21SI
1117964	10459051	12	21SI
1117965	New Serv.	137	21SI

Part Number	Reman Number	Pg	Series
Delco Remy (cont.)			
1117965	10459037	12	21SI
1117966	10459037	12	21SI
1119832	10456391	133	Solenoid
1119835	10456390	133	Solenoid
1119843	10456391	133	Solenoid
1119848	10456391	133	Solenoid
1119853	10456390	133	Solenoid
1119878	10456390	133	Solenoid
1945399	10456391	133	Solenoid
1969194	10456391	133	Solenoid
1977421	19020500	7	10SI
1979872	19020500	7	10SI
1979873	19020500	7	10SI
1979875	19020525	7	10SI
1985155	10463073	20	27SI
1988708	10465149	78	27MT
1990200	10461061	89	40MT
1990205	1990220	89	40MT
1990208	10461061	89	40MT
1990210	1990210	86	40MT
1990220	1990220	86	40MT
1990221	10461046	89	40MT
1990227	1109793	98	50MT
1990228	1109795	98	50MT
1990229	10461057	98	50MT
1990231	10461057	98	50MT
1990232	1109792	98	50MT
1990233	1109555	98	50MT
1990234	1109555	98	50MT
1990235	10461057	98	50MT
1990236	10461499	98	50MT
1990237	10461057	98	50MT
1990238	1109793	98	50MT
1990239	10461057	98	50MT
1990240	1109792	98	50MT
1990243	1109795	98	50MT
1990244	10461382	98	50MT
1990246	10461159	98	50MT
1990247	1109792	98	50MT
1990248	10461057	98	50MT
1990249	10461057	98	50MT
1990250	10461057	98	50MT
1990251	10461057	98	50MT
1990258	10461160	98	50MT
1990259	10461057	98	50MT
1990260	10461057	98	50MT
1990261	10461056	98	50MT
1990262	10461057	98	50MT
1990263	10461057	98	50MT
1990264	10461057	98	50MT
1990265	10461499	98	50MT
1990266	10461057	98	50MT
1990267	10461382	98	50MT
1990268	10461057	98	50MT
1990269	10461057	98	50MT
1990270	10461057	98	50MT
1990271	10461057	98	50MT
1990272	10461057	98	50MT
1990273	10461057	98	50MT
1990274	10461057	98	50MT
1990275	10461159	98	50MT
1990276	10461057	98	50MT
1990277	10461056	98	50MT
1990278	10461382	98	50MT
1990281	10461046	89	40MT
1990282	10461047	89	40MT

Part Number	Reman Number	Pg	Series
Delco Remy (cont.)			
1990283	10461107	89	40MT
1990284	10461057	98	50MT
1990291	1109555	98	50MT
1990298	10461056	98	50MT
1990306	10461045	89	40MT
1990308	10461044	82	37MT
1990309	10461003	82	37MT
1990311	10461069	82	37MT
1990312	10461069	82	37MT
1990315	10461003	82	37MT
1990317	10461089	82	37MT
1990318	10461003	82	37MT
1990322	10461302	82	37MT
1990323	10461045	89	40MT
1990325	10461046	89	40MT
1990330	10461016	82	37MT
1990332	10461016	82	37MT
1990333	10461161	98	50MT
1990337	10461052	92	42MT
1990340	1990210	89	40MT
1990344	10461068	92	42MT
1990347	10461058	82	37MT
1990348	10461052	92	42MT
1990352	10461052	92	42MT
1990355	10461055	92	42MT
1990357	10461025	92	42MT
1990358	10461052	92	42MT
1990359	10461025	92	42MT
1990360	10461025	92	42MT
1990361	10461068	92	42MT
1990362	10461021	92	42MT
1990363	10461052	92	42MT
1990364	10461136	92	42MT
1990366	10461025	92	42MT
1990367	10461068	92	42MT
1990368	10461068	92	42MT
1990369	10461051	92	42MT
1990370	10461021	92	42MT
1990372	10461077	92	42MT
1990373	10461025	92	42MT
1990375	10461052	92	42MT
1990376	10461052	92	42MT
1990377	10461133	92	42MT
1990378	10461068	92	42MT
1990379	10461050	92	42MT
1990380	10461131	92	42MT
1990381	10461135	92	42MT
1990382	10461068	92	42MT
1990383	10461068	92	42MT
1990386	10461052	92	42MT
1990388	10461068	92	42MT
1990391	10461055	92	42MT
1990393	10461055	92	42MT
1990394	10461021	92	42MT
1990397	10461078	92	42MT
1990398	10461052	92	42MT
1990400	10461052	92	42MT
1990401	10461051	92	42MT
1990402	10461025	92	42MT
1990403	10461021	92	42MT
1990404	10461050	92	42MT
1990405	10461050	92	42MT
1990406	10461233	92	42MT
1990407	10461051	92	42MT
1990413	10461025	92	42MT
1990415	10461341	92	42MT

Part Number	Reman Number	Pg	Series
Delco Remy (cont.)			
1990418	10461068	92	42MT
1990419	10461051	92	42MT
1990420	10461052	92	42MT
1990421	10461096	92	42MT
1990422	10461068	92	42MT
1990423	10461052	92	42MT
1990424	10461052	92	42MT
1990428	10461055	92	42MT
1990429	10461021	92	42MT
1990430	10461132	92	42MT
1990431	10461020	92	42MT
1990435	10461137	92	42MT
1990436	10461134	92	42MT
1990437	10461068	92	42MT
1990438	10461133	92	42MT
1990446	10461020	92	42MT
1990447	10461134	92	42MT
1990450	10461052	92	42MT
1990451	10461079	92	42MT
1990453	10461025	92	42MT
1990455	10461025	92	42MT
1990456	10461068	92	42MT
1990460	10461068	92	42MT
1990462	10461047	89	40MT
1990468	10461052	92	42MT
1990470	10461052	92	42MT
1990471	10461021	92	42MT
1990474	10461025	92	42MT
1990475	10461052	92	42MT
1990476	10461051	93	42MT
1990477	10461052	93	42MT
1990478	10461052	93	42MT
1990483	New Serv.	145	42MT
1990483	10461052	93	42MT
1990484	New Serv.	145	42MT
1990484	10461055	93	42MT
1990485	10461068	93	42MT
1990489	New Serv.	145	42MT
1990489	10461075	93	42MT
1990490	New Serv.	145	42MT
1990490	10461053	93	42MT
1990491	10461054	93	42MT
1990492	10461050	93	42MT
1990493	10461068	93	42MT
1990495	10461052	93	42MT
1990496	10461414	93	42MT
1990497	10461358	93	42MT
1990498	10461010	82	37MT
1990499	10461525	82	37MT
1993701	10461015	82	37MT
1993703	10461046	89	40MT
1993705	10461003	82	37MT
1993707	10461016	82	37MT
1993712	10461001	82	37MT
1993726	10461003	82	37MT
1993729	10461016	82	37MT
1993732	10461016	82	37MT
1993738	10461044	82	37MT
1993739	10461407	98	50MT
1993740	10461160	98	50MT
1993741	10461015	82	37MT
1993742	10461018	82	37MT
1993743	10461167	99	50MT
1993745	10461066	182	37MT
1993753	1109555	99	50MT
1993754	10461003	82	37MT

Part Number	Reman Number	Pg	Series
Delco Remy (cont.)			
1993755	10461013	82	37MT
1993759	10461044	82	37MT
1993761	10461069	82	37MT
1993765	10461302	82	37MT
1993767	10461058	82	37MT
1993769	10461003	82	37MT
1993770	10461066	82	37MT
1993776	10461055	93	42MT
1993781	1109792	99	50MT
1993782	10461051	93	42MT
1993783	10461050	93	42MT
1993785	10461133	93	42MT
1993788	10461141	93	42MT
1993789	10461044	82	37MT
1993790	10461001	82	37MT
1993791	10461301	82	37MT
1993794	10461089	82	37MT
1993795	10461021	93	42MT
1993796	10461025	93	42MT
1993798	10461160	99	50MT
1993799	10461001	82	37MT
1993801	10461412	93	42MT
1993802	10461360	93	42MT
1993803	10461052	93	42MT
1993804	10461358	93	42MT
1993805	10461360	93	42MT
1993806	10461414	93	42MT
1993807	10461052	93	42MT
1993808	10461358	93	42MT
1993810	10461360	93	42MT
1993811	10461051	93	42MT
1993812	10461413	93	42MT
1993813	10461091	93	42MT
1993814	10461358	93	42MT
1993815	10461358	93	42MT
1993816	10461052	93	42MT
1993818	10461069	82	37MT
1993820	10461021	93	42MT
1993820	10461021	93	42MT
1993821	10461140	93	42MT
1993822	10461136	93	42MT
1993824	10461079	93	42MT
1993827	10461139	93	42MT
1993829	10461015	82	37MT
1993833	10461136	93	42MT
1993839	10461407	99	50MT
1993842	10461360	93	42MT
1993847	10461407	99	50MT
1993849	10461138	93	42MT
1993854	New Serv.	143	37MT
1993854	10461058	82	37MT
1993856	10461091	93	42MT
1993857	10461133	93	42MT
1993860	10461406	99	50MT
1993863	10461166	93	42MT
1993864	10461056	99	50MT
1993866	10461404	82	37MT
1993869	10461089	82	37MT
1993871	10461089	82	37MT
1993872	10461051	93	42MT
1993874	10461089	82	37MT
1993878	10461013	82	37MT
1993879	10461084	82	37MT
1993880	10461108	82	37MT
1993881	10461303	82	37MT
1993884	10461302	82	37MT

INTERCHANGE



Part Number	Reman Number	Pg	Series
Delco Remy (cont.)			
1993885	10461456	82	37MT
1993886	10461209	82	37MT
1993887	10461066	82	37MT
1993891	10461301	82	37MT
1993893	10461300	82	37MT
1993901	10461016	82	37MT
1993902	10461018	82	37MT
1993903	10461525	82	37MT
1993905	10461130	82	37MT
1993917	10461457	82	37MT
1993920	10461500	82	37MT
1993925	10461324	93	42MT
1993928	10461209	82	37MT
1993929	10461341	93	42MT
1993930	10461297	82	37MT
1993933	10461360	93	42MT
1993935	10461414	93	42MT
1993936	10461358	93	42MT
1993937	10461414	93	42MT
1993938	10461414	93	42MT
1993939	10461414	93	42MT
1993941	10461360	93	42MT
1993943	10461414	93	42MT
1993944	10461358	93	42MT
1993947	10461110	82	37MT
1993950	10461094	82	37MT
1993951	10461094	82	37MT
1993954	10461525	82	37MT
1993955	10461015	83	37MT
1993961	10461021	93	42MT
1993963	10461098	83	37MT
1993964	10461098	83	37MT
1993967	10461299	83	37MT
1993969	10461169	83	37MT
1993972	10461209	83	37MT
1993973	10461078	93	42MT
1993974	10461209	83	37MT
1993979	10461507	83	37MT
1993982	10461326	93	42MT
1993983	10461414	93	42MT
1993989	10461407	99	50MT
1993993	10461025	93	42MT
1993994	10461207	83	37MT
1993996	10461351	93	42MT
1993997	10461209	83	37MT
1993998	10461353	93	42MT
1993999	10461140	93	42MT
1998252	10465158	75	10MT
1998262	10461597	75	10MT
1998281	10465352	75	10MT
1998293	10461629	75	10MT
1998299	10461599	75	10MT
1998313	10465419	75	10MT
1998337	10461616	77	20, 22, 25MT
1998352	10461615	77	20, 22, 25MT
1998353	10461672	77	20, 22, 25MT
1998367	10465347	78	27MT
1998379	10465351	78	27MT
1998380	10465315	79	28MT
1998391	10465409	75	10MT
1998418	10461070	78	27MT
1998423	10465149	78	27MT
1998456	10465149	78	27MT
1998457	10465149	78	27MT
1998485	10465410	75	10MT
1998490	10465149	78	27MT

Part Number	Reman Number	Pg	Series
Delco Remy (cont.)			
1998505	10461672	77	20, 22, 25MT
1998576	10465411	75	10MT
1998599	10465157	75	10MT
8200000	8300025	85	38MT
8200000	New Serv.	144	38MT
8200005	8300005	85	38MT
8200005	New Serv.	144	38MT
8200007	8300022	85	38MT
8200007	New Serv.	144	38MT
8200010	10461770	81	29MT
8200010	New Serv.	143	29MT
8200011	10461772	81	29MT
8200011	New Serv.	143	29MT
8200016	10461739	99	50MT
8200023	8300024	85	38MT
8200023	New Serv.	144	38MT
8200024	8300023	85	38MT
8200024	New Serv.	144	38MT
8200025	8300005	84	38MT
8200025	New Serv.	144	38MT
8200027	10461759	85	39MT
8200027	New Serv.	144	39MT
8200028	10461760	85	39MT
8200028	New Serv.	144	39MT
8200029	10461758	85	39MT
8200029	New Serv.	144	39MT
8200030	New Serv.	144	39MT
8200031	10461755	85	39MT
8200031	New Serv.	144	39MT
8200032	10461756	85	39MT
8200032	New Serv.	144	39MT
8200033	10461753	85	39MT
8200033	New Serv.	144	39MT
8200034	10461754	85	39MT
8200034	New Serv.	144	39MT
8200037	10461334	85	39MT
8200037	New Serv.	144	39MT
8200038	10461755	85	39MT
8200038	New Serv.	144	39MT
8200039	10461756	85	39MT
8200039	New Serv.	144	39MT
8200040	10461753	85	39MT
8200040	New Serv.	144	39MT
8200041	10461754	85	39MT
8200041	New Serv.	144	39MT
8200042	10461757	85	39MT
8200042	New Serv.	144	39MT
8200043	10461758	85	39MT
8200043	New Serv.	144	39MT
8200044	10461759	85	39MT
8200044	New Serv.	144	39MT
8200045	10461760	85	39MT
8200045	New Serv.	144	39MT
8200067	10461771	81	29MT
8200067	New Serv.	143	29MT
8200072	8300025	85	38MT
8200072	New Serv.	144	38MT
8200076	8200076	85	38MT
8200076	New Serv.	144	38MT
8300004	8300004	85	39MT
8300005	8300005	85	38MT
8300007	8300007	85	39MT
8300008	8300008	85	39MT
8300009	8300009	85	39MT
8300014	8300014	85	39MT
8300016	8300016	85	39MT

Part Number	Reman Number	Pg	Series
Delco Remy (cont.)			
8300018	8300018	85	39MT
8300019	8300019	85	39MT
8300021	8300021	84	38MT
8300022	8300022	84	38MT
8300023	8300023	84	38MT
8300024	8300024	84	38MT
8300025	8300025	85	38MT
8300026	8300026	85	38MT
8300030	10461757	85	39MT
8600000	New Serv.	137	11SI
8600009	8700011	16	24SI
8600017	8700019	16	24SI
8600018	8700010	16	24SI
8600019	8700021	16	24SI
8600020	8700019	16	24SI
8300021	8300021	85	38MT
8600030	New Serv.	137	11SI
8600031	New Serv.	137	11SI
8600032	New Serv.	139	24SI
8600032	8600032	16	24SI
8600043	8600043	16	24SI
8600043	New Serv.	139	24SI
8600064	8700016	26	35SI HP
8600064	New Serv.	141	35SI HP
8600065	8700017	26	35SI HP
8600065	New Serv.	141	35SI HP
8600066	8700018	18	35SI HP
8600066	New Serv.	141	35SI HP
8600067	New Serv.	139	24SI
8600068	New Serv.	139	24SI
8600075	New Serv.	137	11SI
8600068	8700021	16	24SI
8700000	8700000	24	35SI
8700001	8700001	25	35SI PAD Mount
8700002	8700002	25	35SI PAD Mount
8700003	8700003	25	35SI QUAD Mount
8700004	8700004	25	35SI PAD Mount
8700005	8700005	24	35SI
8700006	8700006	25	35SI QUAD Mount
8700007	8700007	25	35SI PAD Mount
8700008	8700008	16	24SI
8700009	8700009	16	24SI
8700010	8700010	16	24SI
8700011	8700011	16	24SI
8700012	8700012	16	24SI
8700013	8700013	16	24SI
8700016	8700016	26	35SI HP
8700018	8700018	26	35SI HP
8700017	8700017	26	35SI HP
8700019	8700019	16	24SI
8700021	8700021	16	24SI
8700023	8700023	24	35SI
8700024	8700024	24	35SI
8700026	8700026	24	35SI
8700028	8700028	24	35SI
8700025	8700025	25	35SI QUAD Mount
8700027	8700027	25	35SI QUAD Mount
8700029	8700029	25	35SI QUAD Mount
8700030	8700030	25	35SI PAD Mount
10455305	10465155	75	10MT
10455309	10465152	75	10MT
10455310	10465153	75	10MT
10455311	10465154	75	10MT
10455326	10465412	75	10MT
10455333	10465413	75	10MT
10455336	10465414	75	10MT

Part Number	Reman Number	Pg	Series
Delco Remy (cont.)			
10455337	10465415	75	10MT
10455339	10465416	75	10MT
10455340	10465352	75	10MT
10455341	10465418	75	10MT
10455347	10465409	75	10MT
10455348	10465410	75	10MT
10455349	10465411	75	10MT
10455350	10465412	75	10MT
10455351	10465413	75	10MT
10455352	10465414	75	10MT
10455353	10465415	75	10MT
10455354	10465416	75	10MT
10455355	10465352	75	10MT
10455356	10465418	75	10MT
10455357	10465419	75	10MT
10456390	10456390	133	Solenoid
10456391	10456391	133	Solenoid
10456392	10456393	133	Solenoid
10456392	1115689	147	SSL
10456393	10512653	133	Solenoid
10456393	10461691	134	SSL
10456393	10512653	147	SSL
10456394	1115673	147	SSL
10456496	10459298	27	50DN Gear Drive
10456497	10459297	27	50DN Gear Drive
10456498	10459299	26	50DN Belt Drive
10457728	-	149	Bench Top Tester
10457729	-	149	Bench Top Tester
10457771	-	149	Bench Top Tester
10459000	10459008	21	30SI
10459001	10459008	21	30SI
10459003	10459077	17	25SI and 26SI
10459004	10459004	21	30SI
10459006	10459064	17	25SI and 26SI
10459007	10459076	17	25SI and 26SI
10459008	10459008	21	30SI
10459009	10459009	21	30SI
10459010	10459010	21	30SI
10459011	10459076	17	25SI and 26SI
10459013	10459013	13	21SI
10459014	10459065	17	25SI and 26SI
10459015	10459065	17	25SI and 26SI
10459016	10459016	21	30SI
10459017	10459013	13	21SI
10459018	10459077	17	25SI and 26SI
10459019	10459065	17	25SI and 26SI
10459020	10459020	11	20SI
10459021	10459021	46	JB Series
10459022	10459022	46	JB Series
10459026	10459013	13	21SI
10459027	10459046	13	21SI
10459028	10459453	13	21SI
10459033	10459123	26	50DN Belt Drive
10459035	10459013	13	21SI
10459036	10459013	13	21SI
10459037	10459037	13	21SI
10459038	10459037	13	21SI
10459039	10459013	13	21SI
10459040	10459037	13	21SI
10459041	10459037	13	21SI
10459042	10459013	13	21SI
10459043	10459013	13	21SI
10459044	10459013	13	21SI

Part Number	Reman Number	Pg	Series
Delco Remy (cont.)			
10459045	10459013	13	21SI
10459046	10459046	13	21SI
10459047	10459037	13	21SI
10459048	10459037	13	21SI
10459049	10459453	13	21SI
10459050	10459051	13	21SI
10459051	10459051	13	21SI
10459052	10459051	13	21SI
10459053	10459051	13	21SI
10459054	10459051	13	21SI
10459055	10459013	13	21SI
10459057	10459057	21	30SI
10459059	10459037	13	21SI
10459060	10459124	27	50DN Gear Drive
10459061	10459064	17	25SI and 26SI
10459062	10459076	17	25SI and 26SI
10459063	10459065	17	25SI and 26SI
10459064	10459064	17	25SI and 26SI
10459065	10459065	17	25SI and 26SI
10459066	10459066	17	25SI and 26SI
10459067	10459067	17	25SI and 26SI
10459068	10459065	17	25SI and 26SI
10459069	10459069	19	27SI
10459071	10459076	17	25SI and 26SI
10459072	10459064	17	25SI and 26SI
10459073	10459067	17	25SI and 26SI
10459074	10459065	17	25SI and 26SI
10459075	10459077	17	25SI and 26SI
10459076	10459076	17	25SI and 26SI
10459077	10459077	17	25SI and 26SI
10459079	10459079	21	30SI
10459080	10459080	46	JB Series
10459081	10459081	46	JB Series
10459082	10459013	13	21SI
10459097	10459097	21	30SI
10459104	10459013	13	21SI
10459105	10459037	13	21SI
10459106	10459051	13	21SI
10459107	10459013	13	21SI
10459109	10459013	13	21SI
10459111	10459037	13	21SI
10459113	10459123	26	50DN Belt Drive
10459115	10459013	13	21SI
10459117	10459037	13	21SI
10459118	10459051	13	21SI
10459120	10459120	21	30SI
10459121	10459121	27	50DN Gear Drive
10459122	10459122	27	50DN Gear Drive
10459123	10459123	26	50DN Belt Drive
10459124	10459124	27	50DN Gear Drive
10459125	10459121	27	50DN Gear Drive
10459126	10459122	27	50DN Gear Drive
10459127	10459123	26	50DN Belt Drive
10459128	10459124	27	50DN Gear Drive
10459129	10459121	27	50DN Gear Drive
10459130	10459123	26	50DN Belt Drive
10459131	10459122	27	50DN Gear Drive
10459132	10459065	17	25SI and 26SI
10459133	10459051	13	21SI
10459134	10459013	13	21SI
10459135	10459037	14	21SI
10459136	10459077	17	25SI and 26SI
10459137	10459064	17	25SI and 26SI
10459138	10459079	21	30SI
10459139	10459021	46	JB Series
10459140	10459022	46	JB Series

Part Number	Reman Number	Pg	Series
Delco Remy (cont.)			
10459141	10459141	22	33SI
10459142	10459142	22	33SI
10459143	10459143	22	33SI
10459144	10459144	22	33SI
10459145	10459145	23	34SI QUAD Mount
10459147	10459013	13	21SI
10459148	10459076	17	25SI and 26SI
10459149	10459009	21	30SI
10459150	10459258	21	30SI
10459152	10463073	20	27SI
10459154	10459013	13	21SI
10459155	10459037	13	21SI
10459156	10459051	13	21SI
10459157	10459013	13	21SI
10459158	10459013	13	21SI
10459159	10459037	13	21SI
10459160	10459051	13	21SI
10459161	10459161	17	25SI and 26SI
10459162	10459161	17	25SI and 26SI
10459174	10459013	13	21SI
10459175	10459037	13	21SI
10459176	10459051	13	21SI
10459177	10459013	13	21SI
10459178	10459037	13	21SI
10459179	10459051	13	21SI
10459185	10459013	13	21SI
10459187	10459187	13	21SI
10459188	10459188	14	22SI
10459189	10459189	14	22SI
10459190	10459190	14	22SI
10459194	10459144	22	33SI
10459195	10459141	23	33SI
10459196	10459196	22	33SI
10459197	10459145	23	34SI QUAD Mount
10459198	10459206	23	34SI QUAD Mount
10459199	10459199	23	34SI QUAD Mount
10459200	10459020	11	20SI
10459202	10459008	21	30SI
10459204	10459204	14	22SI
10459205	10459205	14	22SI
10459206	10459206	23	34SI QUAD Mount
10459208	10459081	46	JB Series
10459209	10459013	13	21SI
10459210	10459037	13	21SI
10459211	10459051	13	21SI
10459212	10459212	15	22SI
10459218	10459218	16	23SI
10459235	10459121	27	50DN Gear Drive
10459237	10459057	21	30SI
10459238	10459238	19	27SI
10459244	10459244	19	27SI
10459245	10459245	17	25SI and 26SI
10459246	10459246	21	30SI
10459250	10459250	26	50DN Belt Drive
10459252	10459252	11	20SI
10459258	10459258	21	30SI
10459259	10459259	21	30SI
10459261	10459261	13	21SI
10459262	10459261	13	21SI
10459274	10459274	16	23SI
10459275	10459275	16	23SI
10459277	10459277	16	23SI
10459278	10459278	24	34SI PAD Mount
10459279	10459279	24	34SI PAD Mount
10459287	10459287	23	34SI QUAD Mount
10459288	10459288	24	34SI PAD Mount

INTERCHANGE



Part Number	Reman Number	Pg	Series
Delco Remy (cont.)			
10459294	10459294	16	23SI
10459297	10459297	26	50DN Gear Drive
10459298	10459298	26	50DN Gear Drive
10459299	10459299	26	50DN Belt Drive
10459302	10459013	13	21SI
10459303	10459303	16	23SI
10459304	10459304	10	19SI
10459306	10459306	14	22SI
10459311	10459311	22	33SI
10459314	10459314	22	33SI
10459316	10459316	10	19SI
10459318	10459318	15	22SI PAD Mount
10459320	10459320	15	22SI PAD Mount
10459321	10459321	15	22SI PAD Mount
10459325	10459325	21	30SI
10459333	10459333	14	22SI
10459334	10459334	14	22SI
10459336	10459336	13	21SI
10459338	10459338	9	12SI
10459339	10459339	9	12SI
10459343	10459343	4	10SI
10459344	10459344	4	10SI
10459348	10459348	9	12SI
10459350	10459350	9	12SI
10459351	10459351	4	10SI
10459353	10459353	23	34SI QUAD Mount
10459355	10459355	24	34SI PAD Mount
10459360	10459360	14	22SI
10459363	10459363	39	Ford
10459364	10459364	40	Ford "Blue Back"
10459365	10459365	4	10SI
10459366	10459366	9	15SI
10459367	10459367	9	15SI
10459368	10459368	21	30SI
10459369	10459368	21	30SI
10459372	10459372	16	23SI
10459435	10459435	43	Hitachi
10459436	10459436	63	Nippondenso
10459437	10459437	43	Hitachi
10459439	10459439	63	Nippondenso
10459440	10459440	63	Nippondenso
10459441	10459441	64	Nippondenso
10459442	10459442	64	Nippondenso
10459443	10459443	64	Nippondenso
10459444	10459444	65	Nippondenso
10459445	10459445	65	Nippondenso
10459447	10459447	44	Hitachi
10459448	10459448	44	Hitachi
10459449	10459449	24	34SI PAD Mount
10459450	10459314	22	33SI
10459451	10459451	23	34SI QUAD Mount
10459452	10459452	19	27SI
10459453	10459453	13	21SI
10459454	10459454	50	Motorola
10459456	10459456	14	22SI
10459457	10459457	13	21SI
10459458	10459458	46	JB Series
10459459	10459459	46	JB Series
10459460	10459460	13	21SI
10459461	10459461	13	21SI
10459462	10459462	13	21SI
10459463	10459463	13	21SI
10459465	10459465	66	Nippondenso
10459466	10459466	44	Hitachi
10459467	10459467	45	Hitachi
10459468	10459468	14	22SI

Part Number	Reman Number	Pg	Series
Delco Remy (cont.)			
10459469	10459469	10	19SI
10459494	10459494	66	Nippondenso
10459495	10459495	66	Nippondenso
10459499	10459499	30	Bosch K1
10459472	10459472	14	22SI
10459473	10459473	22	33SI
10459481	10459481	15	22SI PAD Mount
10459482	10459482	15	22SI PAD Mount
10459483	10459483	15	22SI PAD Mount
10459496	10459496	45	Hitachi
10459497	10459497	45	Hitachi
10459498	10459498	32	Bosch N1
10459500	10459500	30	Bosch K1
10459501	10459501	31	Bosch K1
10459502	10459502	38	Ford 6G
10459503	10459503	33	Bosch N1
10459504	10459504	49	Mitsubishi
10459505	10459505	33	Bosch
10459506	10459506	31	Bosch K1
10459507	10459507	67	Nippondenso
10459508	10459508	34	Bosch
10459510	10459510	33	Bosch N1
10459511	10459511	34	Bosch
10459512	10459512	49	Mando
10459513	10459513	49	Mando
10459515	10459515	67	Nippondenso
10459516	10459516	67	Nippondenso
10459517	10459517	68	Nippondenso
10459518	10459518	36	Chrysler
10459517	10459517	68	Nippondenso
10459520	10459520	31	Bosch K1
10459521	10459521	68	Nippondenso
10459522	10459522	34	Bosch
10459524	10459524	40	Ford
10459525	10459525	40	Ford
10459526	10459526	4	10SI
10459527	10459527	69	Prestolite
10459528	10459528	50	Motorola
10459529	10459529	50	Motorola
10459530	10459530	51	Motorola
10459531	10459531	51	Motorola
10459532	10459532	69	Nippondenso
10459533	10459533	51	Motorola
10459534	10459534	52	Motorola
10459535	10459535	52	Motorola
10459536	10459536	52	Motorola
10459537	10459537	35	Bosch
10459539	10459539	53	Motorola
10459540	10459540	53	Motorola
10459541	10459541	53	Motorola
10459542	10459542	54	Motorola
10459543	10459543	54	Motorola
10459544	10459544	69	Nippondenso
10459545	10459545	47	Leece Neville
10459546	10459546	41	Ford
10459547	10459547	13	21SI
10459548	10459548	54	Motorola
10459549	10459549	55	Motorola
10459550	10459550	41	Ford
10459552	10459552	37	Ford 3G
10459553	10459553	37	Ford 3G
10459554	10459554	102	Ford
10459555	10459555	55	Motorola
10459567	10459567	47	Leece Neville
10459568	10459568	48	Leece Neville
10459569	10459569	48	Leece Neville

Part Number	Reman Number	Pg	Series
Delco Remy (cont.)			
10459570	10459570	56	Motorola
10459571	10459571	56	Motorola
10459572	10459572	27	Generator
10459573	10459573	41	Ford
10459574	10459574	27	Generator
10459575	10459575	27	Generator
10459576	10459576	27	Generator
10459577	10459577	27	Generator
10459578	10459578	27	Generator
10459579	10459579	27	Generator
10459580	10459580	27	Generator
10459581	10459581	27	Generator
10459583	10459583	36	Chrysler
10459584	10459584	42	Ford
10459585	10459585	38	Ford 6G
10459586	10459586	38	Ford 6G
10459587	10459587	39	Ford 6G
10459588	10459588	42	Ford
10459589	10459589	42	Ford
10459596	10459596	15	22SI PAD Mount
10459601	10459601	14	22SI
10459602	10459602	15	22SI PAD Mount
10459603	10459603	15	22SI PAD Mount
10459606	10459606	24	35SI
10459607	10459607	25	35SI QUAD Mount
10459608	10459608	25	35SI PAD Mount
10459609	10459609	24	35SI
10459610	10459610	25	35SI QUAD Mount
10459611	10459611	25	35SI PAD Mount
10459612	10459612	24	35SI
10459613	10459613	25	35SI QUAD Mount
10459614	10459614	25	35SI PAD Mount
10461001	10461001	83	37MT
10461003	10461003	83	37MT
10461006	10461058	83	37MT
10461010	10461010	83	37MT
10461011	10461058	83	37MT
10461012	10461066	83	37MT
10461013	10461013	83	37MT
10461015	10461015	83	37MT
10461016	10461016	83	37MT
10461018	10461018	83	37MT
10461020	10461020	91	42MT
10461021	10461021	91	42MT
10461022	10461133	93	42MT
10461024	10461068	93	42MT
10461025	10461025	91	42MT
10461026	10461137	93	42MT
10461027	10461134	93	42MT
10461028	10461055	93	42MT
10461029	10461412	93	42MT
10461030	10461068	93	42MT
10461031	10461358	93	42MT
10461032	10461414	93	42MT
10461033	10461052	93	42MT
10461034	10461051	93	42MT
10461035	10461413	93	42MT
10461036	10461091	93	42MT
10461038	10461052	93	42MT
10461042	10461053	93	42MT
10461043	10461054	93	42MT
10461044	10461044	83	37MT
10461045	10461045	86	40MT
10461046	10461046	86	40MT
10461047	10461047	86	40MT
10461050	10461050	91	42MT

INTERCHANGE

Part Number	Reman Number	Pg	Series
Delco Remy (cont.)			
10461051	10461051	91	42MT
10461052	10461052	91	42MT
10461053	10461053	91	42MT
10461054	10461054	91	42MT
10461055	10461055	91	42MT
10461058	10461058	83	37MT
10461059	10461059	86	40MT
10461060	10461060	86	40MT
10461062	10461075	93	42MT
10461063	10461233	93	42MT
10461065	10461079	93	42MT
10461066	10461066	82	37MT
10461068	10461068	91	42MT
10461069	10461069	83	37MT
10461070	10461070	78	27MT
10461071	10461071	86	40MT
10461073	10461073	86	40MT
10461075	10461075	91	42MT
10461076	10461077	93	42MT
10461077	10461077	91	42MT
10461078	10461078	91	42MT
10461079	10461079	93	42MT
10461080	10461141	93	42MT
10461084	10461084	83	37MT
10461089	10461089	83	37MT
10461090	10461091	93	42MT
10461091	10461091	91	42MT
10461094	10461094	83	37MT
10461096	10461096	91	42MT
10461097	10461131	93	42MT
10461098	10461098	83	37MT
10461107	10461107	86	40MT
10461108	10461108	83	37MT
10461110	10461110	83	37MT
10461125	10461739	99	50MT
10461126	10461052	93	42MT
10461127	10461053	93	42MT
10461129	10461056	99	50MT
10461130	10461130	83	37MT
10461131	10461131	91	42MT
10461132	10461132	91	42MT
10461133	10461133	91	42MT
10461134	10461134	91	42MT
10461135	10461135	91	42MT
10461136	10461136	91	42MT
10461137	10461137	91	42MT
10461138	10461138	91	42MT
10461139	10461139	91	42MT
10461140	10461140	91	42MT
10461141	10461141	91	42MT
10461142	10461358	93	42MT
10461143	10461360	93	42MT
10461145	10461414	93	42MT
10461147	10461411	93	42MT
10461148	10461413	93	42MT
10461151	10461151	91	42MT
10461153	10461417	90	41MT
10461157	10461744	99	50MT
10461158	10461407	99	50MT
10461159	10461159	97	50MT
10461160	10461160	97	50MT
10461161	10461161	97	50MT
10461162	10461162	91	42MT
10461163	10461163	91	42MT
10461164	10461164	92	42MT
10461165	10461165	92	42MT

Part Number	Reman Number	Pg	Series
Delco Remy (cont.)			
10461166	10461166	92	42MT
10461167	10461167	97	50MT
10461169	10461169	83	37MT
10461170	10461170	83	37MT
10461171	10461171	90	41MT
10461172	10461172	92	42MT
10461178	10461045	86	40MT
10461179	10461047	86	40MT
10461182	10461333	90	41MT
10461183	10461055	93	42MT
10461184	10461054	93	42MT
10461185	10461075	93	42MT
10461191	10461738	99	50MT
10461192	10461276	83	37MT
10461193	10461134	93	42MT
10461194	10461133	93	42MT
10461199	10461069	83	37MT
10461201	10461130	83	37MT
10461206	10461233	93	42MT
10461207	10461207	83	37MT
10461209	10461209	83	37MT
10461211	10461172	93	42MT
10461212	10461151	93	42MT
10461213	10461165	93	42MT
10461214	10461164	93	42MT
10461215	10461163	93	42MT
10461216	10461162	93	42MT
10461217	10461134	93	42MT
10461225	10461225	82	37MT
10461226	10459206	23	34SI
10461227	10461171	90	41MT
10461228	10461078	94	42MT
10461231	10461170	83	37MT
10461232	10461096	94	42MT
10461233	10461233	92	42MT
10461235	10461235	13	21SI
10461236	10459037	13	21SI
10461239	10461239	90	41MT
10461240	10461240	90	41MT
10461257	10461257	83	37MT
10461265	10461265	92	42MT
10461266	10461266	92	42MT
10461267	10461267	92	42MT
10461268	10461268	92	42MT
10461269	10461269	92	42MT
10461270	10461270	92	42MT
10461271	10461271	92	42MT
10461272	10461272	92	42MT
10461273	10461225	83	37MT
10461274	10461274	83	37MT
10461276	10461276	83	37MT
10461277	10461277	83	37MT
10461279	10461089	83	37MT
10461282	10461282	90	41MT
10461284	10461295	83	37MT
10461285	10465365	78	28MT
10461295	10461295	83	37MT
10461296	10461296	83	37MT
10461297	10461297	83	37MT
10461298	10461298	83	37MT
10461299	10461299	83	37MT
10461301	10461301	83	37MT
10461302	10461302	83	37MT
10461303	10461303	83	37MT
10461304	10461304	90	41MT
10461318	10461318	90	41MT

Part Number	Reman Number	Pg	Series
Delco Remy (cont.)			
10461319	10461318	90	41MT
10461323	10461324	94	42MT
10461324	10461324	92	42MT
10461326	10461326	92	42MT
10461327	10461326	94	42MT
10461328	10461328	92	42MT
10461329	10461329	92	42MT
10461330	10461330	83	37MT
10461331	10461166	94	42MT
10461332	10461079	94	42MT
10461333	10461333	90	41MT
10461334	10461334	85	39MT
10461337	10461135	94	42MT
10461338	10461341	94	42MT
10461339	10461341	94	42MT
10461350	10461353	94	42MT
10461351	10461351	92	42MT
10461353	10461353	92	42MT
10461354	10461351	94	42MT
10461355	10461140	94	42MT
10461357	10461358	94	42MT
10461358	10461358	92	42MT
10461359	10461360	94	42MT
10461360	10461360	92	42MT
10461365	10461410	94	42MT
10461368	10461160	99	50MT
10461369	10461167	99	50MT
10461377	10461744	99	50MT
10461381	10461382	99	50MT
10461382	10461382	97	50MT
10461384	10461304	90	41MT
10461385	10461169	83	37MT
10461386	10461171	90	41MT
10461387	10461276	83	37MT
10461388	10461388	92	42MT
10461389	10461388	94	42MT
10461390	10461408	90	41MT
10461391	10461409	90	41MT
10461392	10461415	94	42MT
10461393	10461411	94	42MT
10461395	10461417	90	41MT
10461396	10461412	94	42MT
10461397	10461413	94	42MT
10461398	10461414	94	42MT
10461400	10461748	99	50MT
10461401	10461747	99	50MT
10461404	10461404	82	37MT
10461405	10461405	83	37MT
10461408	10461408	90	41MT
10461409	10461409	90	41MT
10461410	10461410	92	42MT
10461411	10461411	92	42MT
10461412	10461412	92	42MT
10461413	10461413	92	42MT
10461414	10461414	92	42MT
10461415	10461415	92	42MT
10461416	10461416	83	37MT
10461417	10461417	90	41MT
10461418	10461418	92	42MT
10461431	10461431	30	41MT
10461434	10461434	90	41MT
10461435	10461435	90	41MT
10461436	10461436	90	41MT
10461439	10461439	90	41MT
10461443	10461443	78	28MT
10461444	10461444	78	28MT

INTERCHANGE



Part Number	Reman Number	Pg	Series
Delco Remy (cont.)			
10461445	10461445	78	28MT
10461446	10461446	78	28MT
10461447	10461447	78	28MT
10461448	10461448	78	28MT
10461449	10461449	78	28MT
10461450	10461450	78	28MT
10461451	10461451	78	28MT
10461452	10461452	78	28MT
10461453	10461453	78	28MT
10461454	10461454	78	28MT
10461456	10461456	82	37MT
10461457	10461457	83	37MT
10461458	10461458	90	41MT
10461459	10461459	78	28MT
10461460	10461460	78	28MT
10461461	10461461	78	28MT
10461463	10461463	78	28MT
10461464	10461464	78	28MT
10461465	10461465	78	28MT
10461466	10461466	78	28MT
10461467	10461467	78	28MT
10461468	10461468	78	28MT
10461469	10461469	78	28MT
10461470	10461470	78	28MT
10461471	10461471	78	28MT
10461472	10461472	78	28MT
10461473	10461473	78	28MT
10461474	10461474	78	28MT
10461475	10461475	78	28MT
10461476	10461476	78	28MT
10461477	10461477	78	28MT
10461478	10461478	78	28MT
10461479	10461479	78	28MT
10461480	10461480	78	28MT
10461481	10461481	78	28MT
10461482	10461482	78	28MT
10461483	10461483	78	28MT
10461484	10461484	78	28MT
10461485	10461485	78	28MT
10461486	10461486	78	28MT
10461487	10461487	78	28MT
10461493	10461493	97	50MT
10461494	10461494	83	37MT
10461496	10461496	90	41MT
10461499	10461499	97	50MT
10461500	10461500	82	37MT
10461501	10461501	92	42MT
10461503	10461503	90	41MT
10461504	10461504	90	41MT
10461507	10461507	83	37MT
10461516	10461516	134	SSL
10461516	10511210	147	SSL
10461518	10461518	112	Nippondenso
10461519	10461519	112	Nippondenso
10461520	10461520	113	Nippondenso
10461521	10461521	113	Nippondenso
10461525	10461525	83	37MT
10461527	10461527	113	Nippondenso
10461528	10461528	90	41MT
10461585	10461585	92	42MT
10461586	10461586	97	50MT
10461591	10461591	92	42MT
10461592	10461592	92	42MT
10461597	10461597	74	10MT
10461598	10461598	77	20, 22, 25MT
10461599	10461599	74	10MT

Part Number	Reman Number	Pg	Series
Delco Remy (cont.)			
10461600	10461600	74	10MT
10461602	10461602	77	20, 22, 25MT
10461603	10461603	74	10MT
10461605	10461605	74	10MT
10461606	10461606	74	10MT
10461608	10461608	108	Mitsubishi
10461609	10461609	77	20, 22, 25MT
10461610	10461610	77	20, 22, 25MT
10461611	10461611	74	10MT
10461612	10461612	74	10MT
10461613	10461613	74	10MT
10461615	10461615	77	20, 22, 25MT
10461616	10461616	77	20, 22, 25MT
10461617	10461617	74	10MT
10461620	10461620	74	10MT
10461621	10461621	103	Hitachi
10461622	10461622	100	Bosch
10461623	10461623	106	Lucas
10461624	10461624	74	10MT
10461625	10461625	74	10MT
10461626	10461626	114	Nippondenso
10461627	10461627	114	Nippondenso
10461628	10461628	115	Nippondenso
10461629	10461629	75	10MT
10461630	10461630	115	Nippondenso
10461631	10461631	106	Lucas
10461633	10461633	109	Mitsubishi
10461635	10461635	107	Lucas
10461637	10461637	101	Bosch
10461638	10461638	101	Bosch
10461639	10461639	101	Bosch
10461640	10461640	115	Nippondenso
10461641	10461641	110	Mitsubishi
10461642	10461642	116	Nippondenso
10461643	10461643	116	Nippondenso
10461644	10461644	116	Nippondenso
10461645	10461645	117	Nippondenso
10461646	10461646	117	Nippondenso
10461647	10461647	118	Nippondenso
10461648	10461648	118	Nippondenso
10461649	10461649	74	10MT
10461650	10461650	118	Nippondenso
10461651	10461651	110	Mitsubishi
10461652	10461652	119	Nippondenso
10461653	10461653	119	Nippondenso
10461655	10461655	120	Nippondenso
10461656	10461656	120	Nippondenso
10461657	10461657	120	Nippondenso
10461658	10461658	121	Nippondenso
10461659	10461659	104	Hitachi
10461660	10461660	104	Hitachi
10461661	10461661	74	10MT
10461662	10461662	74	10MT
10461663	10461663	102	Ford
10461668	10461668	74	10MT
10461669	10461669	74	10MT
10461671	10461671	74	10MT
10461672	10461672	77	20, 22, 25MT
10461673	10461672	77	20, 22, 25MT
10461677	10461677	74	10MT
10461678	10461678	77	20, 22, 25MT
10461683	10461683	121	Nippondenso
10461684	10461684	121	Nippondenso
10461685	10461685	122	Nippondenso
10461686	10461686	110	Mitsubishi

Part Number	Reman Number	Pg	Series
Delco Remy (cont.)			
10461696	10461696	74	10MT
10461700	10461700	74	10MT
10461701	10461701	74	10MT
10461709	10461709	131	Prestolite
10461710	10461710	132	Prestolite
10461712	10461712	132	Prestolite
10461713	10461713	133	Prestolite
10461714	10461714	122	Nippondenso
10461731	10461734	97	50MT
10461732	10461732	97	50MT
10461733	10461733	97	50MT
10461734	10461734	97	50MT
10461735	10461735	97	50MT
10461737	10461737	97	50MT
10461738	10461738	97	50MT
10461739	10461739	97	50MT
10461740	10461740	97	50MT
10461741	10461741	97	50MT
10461744	10461744	97	50MT
10461745	10461745	97	50MT
10461746	10461746	97	50MT
10461747	10461747	97	50MT
10461748	10461748	97	50MT
10461749	10461749	97	50MT
10461753	10461753	85	39MT
10461754	10461754	85	39MT
10461755	10461755	85	39MT
10461756	10461756	85	39MT
10461757	10461757	85	39MT
10461758	10461758	85	39MT
10461759	10461759	85	39MT
10461760	10461760	85	39MT
10461764	10461764	81	29MT
10461765	10461765	81	29MT
10461768	10461768	85	38MT
10461769	10461769	85	38MT
10461770	10461770	81	29MT
10461771	10461771	81	29MT
10461772	10461772	81	29MT
10461773	10461773	85	39MT
10461777	10461777	85	39MT
10462155	10462155	92	42MT
10462175	10462175	92	42MT
10462196	10462196	92	42MT
10463072	10463072	19	27SI
10463073	10463073	19	27SI
10463074	10463074	19	27SI
10463160	10463160	19	27SI
10463161	10463161	19	27SI
10463449	10463449	43	Ford
10465013	10465296	79	28MT
10465014	10465168	79	28MT
10465043	10465043	79	28MT
10465060	10465060	74	10MT
10465108	10465171	75	10MT
10465149	10465149	78	27MT
10465150	10465150	99	28MT
10465151	10465151	99	28MT
10465152	10465152	74	10MT
10465153	10465153	74	10MT
10465154	10465154	74	10MT
10465155	10465155	74	10MT
10465157	10465158	74	10MT
10465158	10465158	74	10MT
10465168	10465168	79	28MT
10465171	10465171	74	10MT

Part Number	Reman Number	Pg	Series	Part Number	Reman Number	Pg	Series	Part Number	Reman Number	Pg	Series
Delco Remy (cont.)				Delco Remy (cont.)				Delco Remy (cont.)			
10465239	10465239	79	28MT	10478829	10461160	99	50MT	10478988	10461360	94	42MT
10465295	10465295	79	28MT	10478830	10461167	99	50MT	10478994	10461414	94	42MT
10465296	10465296	79	28MT	10478831	New Serv.	143	37MT	10478995	10461358	94	42MT
10465315	10465315	79	28MT	10478831	10461209	83	37MT	10478998	New Serv.	145	42MT
10465347	10465347	78	27MT	10478832	10461326	94	42MT	10478998	10461068	94	42MT
10465348	10465348	78	28MT	10478835	10461414	94	42MT	10478999	New Serv.	145	41MT
10465349	10465349	78	28MT	10478836	10461140	94	42MT	10478999	10461171	90	41MT
10465351	10465351	78	27MT	10478839	10461412	94	42MT	10479003	10461051	94	42MT
10465352	10465352	74	10MT	10478847	10461407	99	50MT	10479004	10461414	94	42MT
10465365	10465365	78	28MT	10478848	10461378	99	50MT	10479006	10461326	94	42MT
10465403	10465043	79	28MT	10478860	10461407	99	50MT	10479008	10461413	94	42MT
10465404	10465365	79	28MT	10478863	10461378	99	50MT	10479009	10461358	94	42MT
10465407	10465043	79	28MT	10478864	10461407	99	50MT	10479010	10461360	94	42MT
10465408	10465239	79	28MT	10478865	10461378	99	50MT	10479012	10461412	94	42MT
10465409	10465409	74	10MT	10478866	10461378	99	50MT	10479013	10461417	90	41MT
10465410	10465410	74	10MT	10478869	10461407	99	50MT	10479015	10461416	83	37MT
10465411	10465411	74	10MT	10478877	10461056	99	50MT	10479017	10461411	94	42MT
10465412	10465412	74	10MT	10478879	10461382	99	50MT	10479018	10461166	94	42MT
10465413	10465413	74	10MT	10478880	10461057	99	50MT	10479019	10461324	94	42MT
10465414	10465414	74	10MT	10478882	10461406	99	50MT	10479020	10461209	83	37MT
10465415	10465415	74	10MT	10478882	10461747	99	50MT	10479021	10461415	94	42MT
10465416	10465416	74	10MT	10478890	10461170	83	37MT	10479022	10461410	94	42MT
10465417	10465352	75	10MT	10478892	10461351	94	42MT	10479023	10461409	90	41MT
10465418	10465418	74	10MT	10478893	10461353	94	42MT	10479024	10461408	90	41MT
10465419	10465419	74	10MT	10478894	10461052	94	42MT	10479026	10461162	94	42MT
10465423	10465409	75	10MT	10478895	10461052	94	42MT	10479027	10461163	94	42MT
10465424	10465410	75	10MT	10478898	10461333	90	41MT	10479028	10461164	94	42MT
10465425	10465411	75	10MT	10478903	10461407	99	50MT	10479030	10461165	94	42MT
10465426	10465412	75	10MT	10478904	10461056	99	50MT	10479037	10461052	94	42MT
10465427	10465413	75	10MT	10478905	10461382	99	50MT	10479038	10461055	94	42MT
10465428	10465414	75	10MT	10478906	10461056	99	50MT	10479040	10461151	94	42MT
10465429	10465415	75	10MT	10478908	10461378	99	50MT	10479041	10461172	94	42MT
10465430	10465416	75	10MT	10478910	10461056	99	50MT	10479043	10461503	90	41MT
10465431	10465352	75	10MT	10478911	10461057	99	50MT	10479062	10461055	94	42MT
10465432	10465418	75	10MT	10478916	10461160	99	50MT	10479065	10461415	94	42MT
10465433	10465419	75	10MT	10478918	10461051	94	42MT	10479068	10461207	83	37MT
10465437	10465437	105	Hitachi	10478919	10461160	99	50MT	10479069	10461209	83	37MT
10465438	10465438	105	Hitachi	10478921	10461494	83	37MT	10479072	10461052	94	42MT
10465440	10465440	123	Nippondenso	10478931	10461414	94	42MT	10479078	10461388	94	42MT
10465442	10465442	123	Nippondenso	10478932	10461411	94	42MT	10479079	10461504	90	41MT
10465444	10465444	124	Nippondenso	10478934	10461414	94	42MT	10479081	10461052	94	42MT
10465449	10465412	75	10MT	10478936	10461414	94	42MT	10479082	10461055	94	42MT
10465450	10465415	75	10MT	10478937	10461360	94	42MT	10479100	10461410	94	42MT
10465528	10465528	125	Nippondenso	10478938	10461360	94	42MT	10479102	10461282	90	41MT
10465530	10465530	126	Nippondenso	10478939	10461358	94	42MT	10479108	10461209	83	37MT
10465532	10465532	127	Nippondenso	10478940	10461413	94	42MT	10479109	10461240	91	41MT
10465533	10465533	127	Nippondenso	10478941	10461358	94	42MT	10479119	10461360	94	42MT
10465534	10465534	127	Nippondenso	10478942	10461358	94	42MT	10479120	10461358	94	42MT
10465536	10465536	128	Nippondenso	10478943	10461360	94	42MT	10479136	10461358	94	42MT
10465537	10465537	128	Nippondenso	10478944	10461358	94	42MT	10479144	10461745	99	50MT
10465538	10465538	129	Nippondenso	10478945	10461412	94	42MT	10479145	10461378	99	50MT
10465539	10465539	129	Nippondenso	10478946	10461360	94	42MT	10479148	10461528	91	41MT
10465540	10465540	129	Nippondenso	10478947	10461358	94	42MT	10479149	10461360	94	42MT
10465541	10465541	130	Nippondenso	10478952	10461360	94	42MT	10479150	10461052	94	42MT
10478806	10461098	83	37MT	10478951	10461417	90	41MT	10479153	10461493	99	50MT
10478807	10461160	99	50MT	10478962	10461328	94	42MT	10479154	10461265	94	42MT
10478808	10461160	99	50MT	10478965	10461079	94	42MT	10479155	10461266	94	42MT
10478809	10461591	94	42MT	10478966	10461166	94	42MT	10479156	10461267	94	42MT
10478810	New Serv.	145	42MT	10478967	10461324	94	42MT	10479157	10461268	94	42MT
10478810	10461592	94	42MT	10478976	10461209	83	37MT	10479158	10461269	94	42MT
10478811	10461405	83	37MT	10478977	10461051	94	42MT	10479159	10461270	94	42MT
10478812	10461304	90	41MT	10478978	10461132	94	42MT	10479160	10461271	94	42MT
10478813	10461056	99	50MT	10478979	10461140	94	42MT	10479161	10461272	94	42MT
10478817	10461239	90	41MT	10478980	10461068	94	42MT	10479164	10461068	94	42MT
10478818	10461240	90	41MT	10478985	10461133	94	42MT	10479165	10461318	91	41MT
10478824	10461585	94	42MT	10478986	10461068	94	42MT	10479168	10461410	94	42MT

INTERCHANGE



Part Number	Reman Number	Pg	Series
Delco Remy (cont.)			
10479176	10461316	83	37MT
10479178	10461358	94	42MT
10479187	10461330	83	37MT
10479190	10461378	99	50MT
10479191	10461328	94	42MT
10479192	10461329	94	42MT
10479195	10461298	83	37MT
10479199	10461493	99	50MT
10479200	10461493	99	50MT
10479200	10461749	99	50MT
10479205	10461458	91	41MT
10479206	10461434	91	41MT
10479214	10461170	83	37MT
10479215	10461431	91	41MT
10479218	10461586	99	50MT
10479226	New Serv.	145	41MT
10479226	10461282	91	41MT
10479232	10461528	91	41MT
10479238	10461418	94	42MT
10479242	10461496	91	41MT
10479243	10461439	91	41MT
10479246	10461436	91	41MT
10479249	10461496	91	41MT
10479250	10461435	91	41MT
10479251	10461501	94	42MT
10479265	10462155	94	42MT
10479266	10462196	95	42MT
10479267	10462175	95	42MT
10479277	10461052	95	42MT
10479286	10461360	95	42MT
10479323	New Serv.	145	50MT
10479323	10461739	99	50MT
10479327	10461499	99	50MT
10479328	10461738	99	50MT
10479331	10461159	99	50MT
10479335	10461382	99	50MT
10479336	10461738	99	50MT
10479338	10461738	99	50MT
10479339	New Serv.	145	50MT
10479343	10461744	99	50MT
10479344	10461493	99	50MT
10479600	10461459	79	28MT
10479604	10461460	79	28MT
10479605	10461461	79	28MT
10479607	10461463	79	28MT
10479608	10461464	79	28MT
10479611	10461453	79	28MT
10479613	10465348	79	28MT
10479614	New Serv.	143	28MT
10479614	10465150	79	28MT
10479615	10465151	79	28MT
10479616	10461465	79	28MT
10479617	10461466	79	28MT
10479618	10465151	79	28MT
10479619	10461452	79	28MT
10479620	10461467	79	28MT
10479621	10465043	79	28MT
10479622	10461468	79	28MT
10479623	10461469	79	28MT
10479624	10465365	79	28MT
10479625	10465151	79	28MT
10479626	10461470	79	28MT
10479628	10461471	79	28MT
10479629	10461472	79	28MT
10479630	New Serv.	143	28MT
10479630	10461473	79	28MT

Part Number	Reman Number	Pg	Series
Delco Remy (cont.)			
10479634	10461474	79	28MT
10479636	10461475	79	28MT
10479637	10461476	79	28MT
10479638	10461477	79	28MT
10479639	10461478	79	28MT
10479640	10461479	79	28MT
10479641	10461480	79	28MT
10479642	10461481	79	28MT
10479643	10461479	79	28MT
10479644	10461480	79	28MT
10479645	10461454	79	28MT
10479825	19020506	10	15SI
10479850	10459350	9	12SI
10480058	10459344	7	10SI
10497177	10463072	20	27SI
10500056	–	145	Intelli-Scan
10500057	–	145	Intelli-Scan
10500058	–	145	Intelli-Scan
10500059	–	145	Intelli-Scan
10500060	–	145	Intelli-Scan
10500061	–	145	Intelli-Scan
10500062	–	145	Intelli-Scan
10500063	–	145	Intelli-Scan
10500064	–	145	Intelli-Scan
10500065	–	145	Intelli-Scan
10500066	–	145	Intelli-Scan
10500067	–	145	Intelli-Scan
10500069	–	145	Intelli-Scan
10500070	–	145	Intelli-Scan
10500071	–	145	Intelli-Scan
10500072	–	145	Intelli-Scan
10500073	–	145	Intelli-Scan
10500074	–	145	Intelli-Scan
10500075	–	145	Intelli-Scan
10500076	–	145	Intelli-Scan
10500077	–	145	Intelli-Scan
10500123	–	149	Bench Top Tester
10500190	–	145	Intelli-Scan
10500191	–	145	Intelli-Scan
10500194	–	145	Intelli-Scan
10500195	–	145	Intelli-Scan
10500418	–	146	1750 W Install Kit
10500419	–	146	400 W Install Kit
10500478	–	146	600 W Install Kit
10500479	–	146	1000 W Install Kit
10503176	–	149	Intelli-Check2
10503559	–	149	Intelli-Check2
10503560	–	149	Intelli-Check2
10503805	10503805	27	50VR
10503806	10503806	27	50VR
10503807	10503807	27	50VR
10511211	New Serv.	142	Solenoid
10511214	New Serv.	142	Solenoid
10511215	New Serv.	142	Solenoid
10511217	New Serv.	142	Solenoid
10511219	New Serv.	142	Solenoid
10512653	10512653	134	SSL
10512657	–	149	Intelli-Check2
10512658	–	149	Intelli-Check2
10512661	–	149	Intelli-Check2
19009950	10459469	10	19SI
19009951	New Serv.	137	19SI
19009952	10459469	10	19SI
19009957	10459316	10	19SI
19009958	10459304	10	19SI

Part Number	Reman Number	Pg	Series
Delco Remy (cont.)			
19010000	10459076	17	25SI and 26SI
19010001	10459064	17	25SI and 26SI
19010002	10459076	17	25SI and 26SI
19010003	10459065	17	25SI and 26SI
19010004	10459245	17	25SI and 26SI
19010005	10459066	17	25SI and 26SI
19010006	10459064	17	25SI and 26SI
19010007	10459067	17	25SI and 26SI
19010008	10459076	17	25SI and 26SI
19010009	10459065	17	25SI and 26SI
19010010	10459067	17	25SI and 26SI
19010011	10459067	17	25SI and 26SI
19010012	10459067	17	25SI and 26SI
19010013	10459067	17	25SI and 26SI
19010014	10459067	17	25SI and 26SI
19010018	10459161	17	25SI and 26SI
19010019	10459065	17	25SI and 26SI
19010020	10459064	17	25SI and 26SI
19010024	10459076	17	25SI and 26SI
19010100	New Serv.	137	21SI
19010100	10459013	12	21SI
19010101	10459013	12	21SI
19010102	10459013	12	21SI
19010103	10459013	12	21SI
19010104	10459037	12	21SI
19010105	New Serv.	137	21SI
19010105	10459013	12	21SI
19010108	10459461	12	21SI
19010110	New Serv.	137	21SI
19010110	10459457	12	21SI
19010111	10461235	12	21SI
19010112	New Serv.	137	21SI
19010112	10459046	12	21SI
19010114	10459013	12	21SI
19010115	10459037	12	21SI
19010116	10459037	12	21SI
19010118	10459463	12	21SI
19010120	10459037	12	21SI
19010124	10459037	12	21SI
19010125	10459051	12	21SI
19010126	New Serv.	137	21SI
19010126	10459336	12	21SI
19010127	10459051	12	21SI
19010129	10459037	12	21SI
19010134	10459037	12	21SI
19010136	10459013	12	21SI
19010137	10459037	12	21SI
19010138	10459051	12	21SI
19010141	10459013	12	21SI
19010145	10459037	12	21SI
19010146	10459013	12	21SI
19010147	10459037	12	21SI
19010150	10459037	12	21SI
19010153	10459037	12	21SI
19010154	10459013	12	21SI
19010155	10459037	12	21SI
19010156	10459051	12	21SI
19010157	10459013	12	21SI
19010158	10459013	12	21SI
19010159	10459013	12	21SI
19010160	10459013	12	21SI
19010161	10459037	12	21SI
19010162	10459037	12	21SI
19010163	10459037	12	21SI
19010164	10459013	12	21SI
19010165	10459037	12	21SI

Part Number	Reman Number	Pg	Series
Delco Remy (cont.)			
19010166	10459037	12	21SI
19010168	10459462	12	21SI
19010170	10459037	12	21SI
19010171	10459037	12	21SI
19010172	10459037	12	21SI
19010173	10459037	12	21SI
19010174	10459051	12	21SI
19010175	10459051	12	21SI
19010176	10459051	12	21SI
19010179	10459051	12	21SI
19010180	10459187	12	21SI
19010181	10459013	12	21SI
19010182	10461235	12	21SI
19010185	10459261	12	21SI
19010186	10459013	12	21SI
19010187	10459037	12	21SI
19010188	10459037	12	21SI
19010189	10459051	12	21SI
19010190	10459013	12	21SI
19010191	10459037	12	21SI
19010192	10459051	12	21SI
19010194	10459013	12	21SI
19010195	10461235	12	21SI
19010196	10459037	12	21SI
19010200	10459261	12	21SI
19010207	10459037	13	21SI
19010209	10459013	13	21SI
19010210	10459037	13	21SI
19010212	10459037	13	21SI
19010213	10459013	13	21SI
19011000	10459218	16	23SI
19011003	10459277	16	23SI
19011009	New Serv.	138	23SI
19011009	10459275	16	23SI
19011010	10459274	16	23SI
19011014	10459274	16	23SI
19011015	10459372	16	23SI
19011016	New Serv.	138	23SI
19011016	10459294	16	23SI
19011017	New Serv.	138	23SI
19011017	10459303	16	23SI
19011019	10459274	16	23SI
19011100	New Serv.	139	31SI
19011101	New Serv.	139	31SI
19011104	New Serv.	139	31SI
19011105	New Serv.	139	31SI
19011107	New Serv.	139	31SI
19011108	New Serv.	139	31SI
19011150	New Serv.	139	33SI
19011150	10459144	23	33SI
19011151	10459143	23	33SI
19011152	10459142	23	33SI
19011153	10459196	23	33SI
19011154	10459143	23	33SI
19011155	New Serv.	139	33SI
19011155	10459141	23	33SI
19011156	10459142	23	33SI
19011157	New Serv.	140	34SI QUAD Mount
19011157	10459145	23	34SI QUAD Mount
19011158	10459143	22	33SI
19011159	10459142	22	33SI
19011160	10459143	22	33SI
19011161	10459142	22	33SI
19011162	10459143	22	33SI
19011163	10459142	22	33SI
19011164	10459473	22	33SI

Part Number	Reman Number	Pg	Series
Delco Remy (cont.)			
19011167	New Serv.	140	34SI QUAD Mount
19011167	10459206	23	34SI QUAD Mount
19011168	10459199	23	34SI QUAD Mount
19011169	10459145	23	34SI QUAD Mount
19011170	10459206	23	34SI QUAD Mount
19011173	10459142	23	33SI
19011174	10459143	23	33SI
19011175	10459196	23	33SI
19011176	10459279	24	34SI PAD Mount
19011177	New Serv.	140	34SI PAD Mount
19011177	10459278	24	34SI PAD Mount
19011179	New Serv.	140	34SI QUAD Mount
19011179	10459287	23	34SI QUAD Mount
19011181	10459010	21	30SI
19011187	New Serv.	140	34SI PAD Mount
19011187	10459288	24	34SI PAD Mount
19011189	10459353	23	34SI QUAD Mount
19011191	10459353	23	34SI QUAD Mount
19011192	10459311	23	33SI
19011193	10459314	23	33SI
19011194	10459355	24	34SI PAD Mount
19011195	10459353	23	34SI QUAD Mount
19011200	10459450	23	33SI
19011201	10459451	23	34SI QUAD Mount
19011202	10459449	24	34SI PAD Mount
19011205	10459353	23	34SI QUAD Mount
19011208	10459199	23	34SI QUAD Mount
19011211	10459144	23	33SI
19011212	New Serv.	139	33SI
19011212	10459141	23	33SI
19011214	New Serv.	140	34SI QUAD Mount
19011214	10459206	23	34SI QUAD Mount
19011216	New Serv.	140	34SI PAD Mount
19011216	10459278	24	34SI PAD Mount
19011227	8700023	25	35SI
19011227	New Serv.	140	35SI
19011228	10459606	25	35SI
19011228	New Serv.	140	35SI
19011229	10459609	25	35SI
19011229	New Serv.	140	35SI
19011231	8700024	25	35SI
19011231	New Serv.	140	35SI
19011232	8700000	25	35SI
19011232	New Serv.	140	35SI
19011234	10459607	25	35SI QUAD Mount
19011234	New Serv.	141	35SI QUAD Mount
19011244	10459610	25	35SI QUAD Mount
19011244	New Serv.	141	35SI QUAD Mount
19011246	8700025	25	35SI QUAD Mount
19011246	New Serv.	141	35SI QUAD Mount
19011248	8700026	25	35SI
19011248	New Serv.	140	35SI
19011249	8700027	25	35SI QUAD Mount
19011249	New Serv.	144	35SI QUAD Mount
19011252	10459608	25	35SI PAD Mount
19011252	New Serv.	141	35SI PAD Mount
19011253	10459611	25	35SI PAD Mount
19011253	New Serv.	141	35SI PAD Mount
19011255	New Serv.	144	35SI QUAD Mount
19011258	New Serv.	141	35SI PAD Mount
19011260	10459612	25	35SI
19011260	New Serv.	140	35SI
19011261	10459613	25	35SI QUAD Mount
19011262	10459614	25	35SI PAD Mount
19011262	New Serv.	141	35SI PAD Mount
19011263	8700028	25	35SI

Part Number	Reman Number	Pg	Series
Delco Remy (cont.)			
19011263	New Serv.	140	35SI
19011264	New Serv.	140	35SI
19011265	8700029	25	35SI QUAD Mount
19011265	New Serv.	144	35SI QUAD Mount
19011265	New Serv.	144	35SI QUAD Mount
19011266	New Serv.	144	35SI QUAD Mount
19011267	8700030	25	35SI PAD Mount
19011267	New Serv.	141	35SI PAD Mount
19011268	New Serv.	141	35SI PAD Mount
19011272	8700001	25	35SI PAD Mount
19011272	New Serv.	141	35SI PAD Mount
19011273	8700002	25	35SI PAD Mount
19011273	New Serv.	141	35SI PAD Mount
19011400	10461770	81	29MT
19011400	New Serv.	143	29MT
19011402	10461771	81	29MT
19011402	New Serv.	143	29MT
19011403	10461772	81	29MT
19011403	New Serv.	143	29MT
19011404	10461764	81	29MT
19011404	New Serv.	143	29MT
19011407	10461764	81	29MT
19011407	New Serv.	143	29MT
19011409	10461765	81	29MT
19011409	New Serv.	143	29MT
19011500	10461334	85	39MT
19011500	New Serv.	144	39MT
19011505	10461334	85	39MT
19011506	10461753	85	39MT
19011506	New Serv.	144	39MT
19011507	10461754	85	39MT
19011507	New Serv.	144	39MT
19011508	10461755	85	39MT
19011508	New Serv.	144	39MT
19011509	10461756	85	39MT
19011509	New Serv.	144	39MT
19011510	10461757	85	39MT
19011510	New Serv.	144	39MT
19011511	10461758	85	39MT
19011511	New Serv.	144	39MT
19011512	10461759	85	39MT
19011512	New Serv.	144	39MT
19011513	10461760	85	39MT
19011513	New Serv.	144	39MT
19011514	10461773	85	39MT
19011514	New Serv.	144	39MT
19011515	8300004	85	39MT
19011515	New Serv.	144	39MT
19011516	10461777	85	39MT
19011516	New Serv.	144	39MT
19011517	10461757	85	39MT
19011517	New Serv.	144	39MT
19011518	10461753	85	39MT
19011518	New Serv.	144	39MT
19011521	8300009	85	39MT
19011521	New Serv.	144	39MT
19011522	8300018	85	39MT
19011522	New Serv.	144	39MT
19011523	8300016	85	39MT
19011523	New Serv.	144	39MT
19011524	8300014	85	39MT
19011524	New Serv.	144	39MT
19011525	8300008	85	39MT
19011525	New Serv.	144	39MT
19011526	8300007	85	39MT
19011526	New Serv.	144	39MT

INTERCHANGE



Part Number	Reman Number	Pg	Series
Delco Remy (cont.)			
19011529	8300019	85	39MT
19011529	New Serv.	144	39MT
19011530	10461753	85	39MT
19011530	New Serv.	144	39MT
19011531	10461334	85	39MT
19011531	New Serv.	144	39MT
19016031	New Serv.	144	38MT
19020207	New Serv.	137	11SI
19020208	New Serv.	137	11SI
19020209	New Serv.	137	11SI
19020300	10459188	14	22SI
19020302	10459189	14	22SI
19020303	10459190	14	22SI
19020304	10459212	14	22SI
19020305	10459204	14	22SI
19020306	10459205	14	22SI
19020307	New Serv.	138	22SI
19020307	10459306	14	22SI
19020308	New Serv.	138	22SI
19020309	New Serv.	138	22SI
19020310	New Serv.	138	22SI
19020312	10459360	14	22SI
19020346	10459333	14	22SI
19020354	10459360	14	22SI
19020358	10459190	14	22SI
19020359	10459190	14	22SI
19020360	10459360	14	22SI
19020362	10459360	14	22SI
19020363	10459360	14	22SI
19020364	10459190	14	22SI
19020365	10459190	14	22SI
19020366	10459468	15	22SI
19020375	10459456	15	22SI
19020377	10459188	15	22SI
19020378	10459482	15	22SI PAD Mount
19020379	10459204	15	22SI
19020380	10459212	15	22SI
19020381	10459472	15	22SI
19020382	10459306	15	22SI
19020383	10459468	15	22SI
19020384	10459483	15	22SI PAD Mount
19020385	10459481	15	22SI PAD Mount
19020387	10459318	15	22SI PAD Mount
19020388	10459320	15	22SI PAD Mount
19020389	10459321	15	22SI PAD Mount
19020391	10459334	15	22SI
19020394	10459596	15	22SI PAD Mount
19020411	10503805	27	50VR
19020412	10503806	27	50VR
19020413	10503807	27	50VR
19020475	10500242	148	LVD
19020477	10500389	148	LVD
19020479	10500242	148	LVD
19020480	10500389	148	LVD
19020481	-	145	Intelli-Scan
19020482	-	145	Intelli-Scan
19020483	-	145	Intelli-Scan
19020484	-	145	Intelli-Scan
19020485	-	145	Intelli-Scan
19020486	10500242	148	LVD
19020489	-	145	Intelli-Scan
19020490	10500242	148	LVD
19020492	10502363	148	LVD
19020494	10500389	148	LVD
19020496	10500242	148	LVD
19020497	10500451	148	LVD

Part Number	Reman Number	Pg	Series
Delco Remy (cont.)			
19020498	10500389	148	LVD
19020499	10502122	148	LVD
19020500	19020500	4	10SI
19020501	19020501	4	10SI
19020504	19020504	19	27SI
19020505	19020505	9	12SI
19020506	19020506	9	15SI
19020507	19020507	35	Bosch
19020508	19020508	35	Bosch
19020509	19020509	57	Motorola
19020510	19020510	57	Motorola
19020512	19020512	58	Motorola
19020514	19020514	58	Motorola
19020515	19020515	59	Motorola
19020516	19020516	4	10SI
19020517	19020525	7	10SI
19020519	19020519	59	Motorola
19020520	19020520	60	Motorola
19020521	19020521	4	10SI
19020525	19020525	4	10SI
19020526	19020526	4	10SI
19020528	19020528	9	12SI
19020529	19020529	9	12SI
19020531	19020526	7	10SI
19020535	19020535	32	Bosch K1
19020536	19020536	32	Bosch K1
19020543	19020543	60	Motorola
19020544	19020544	61	Motorola
19020545	19020545	61	Motorola
19020546	19020546	62	Motorola
19020565	1902565	37	Ford 3G
19020581	19020581	36	Bosch
19020582	19020582	62	Motorola
19020801	10459189	15	22SI
19020803	10459320	15	22SI PAD Mount
19020804	10459321	15	22SI PAD Mount
19020806	10459188	15	22SI
19020808	10459318	15	22SI PAD Mount
19020810	10459481	15	22SI PAD Mount
19020811	10459482	15	22SI PAD Mount
19020812	10459483	15	22SI PAD Mount
19020813	10459601	15	22SI
19020824	10459602	15	22SI
19020825	10459603	15	22SI
19020888	New Serv.	138	22SI PAD Mount
19020889	New Serv.	138	22SI PAD Mount
19020900	19020900	16	24SI
19020900	New Serv.	139	24SI
19020901	19020901	16	24SI
19020901	New Serv.	139	24SI
19020902	19020902	16	24SI
19020902	New Serv.	139	24SI
19020903	19020903	16	24SI
19020903	New Serv.	139	24SI
19021003	-	146	1750 W Inverter
19021004	-	146	400 W Inverter
19021005	-	146	150 W Inverter
19021006	-	146	600 W Inverter
19021007	-	146	1000 W Inverter
19021008	-	145	Intelli-Scan
19023060	8300025	85	38MT
19023060	New Serv.	144	38MT
19025330	New Serv.	142	Bosch T1
19025331	New Serv.	142	Bosch T1
19025333	New Serv.	142	Bosch T1
19025335	New Serv.	142	Bosch T1

Part Number	Reman Number	Pg	Series
Delco Remy (cont.)			
19025336	New Serv.	142	Bosch T1
19025337	New Serv.	142	Bosch T1
19026026	8300025	85	38MT
19026026	New Serv.	144	38MT
19026027	10461768	85	38MT
19026027	New Serv.	144	38MT
19026028	10461769	85	38MT
19026028	New Serv.	144	38MT
19026029	8300005	85	38MT
19026029	New Serv.	144	38MT
19026031	8300024	85	38MT
19026032	8300023	85	38MT
19026032	New Serv.	144	38MT
19026035	8300026	85	38MT
19026035	New Serv.	144	38MT
19079038	10461055	95	42MT
Detroit Diesel			
10459108	10459008	22	30SI
10459109	10459013	13	21SI
10459111	10459037	13	21SI
10459114	10459299	26	50DN Belt Drive
10459129	10459121	27	50DN Gear Drive
10459130	10459123	26	50DN Belt Drive
10459131	10459122	27	50DN Gear Drive
10459132	10459065	18	25SI and 26SI
10459133	10459051	13	21SI
10459134	10459013	13	21SI
10459135	10459037	13	21SI
10459136	10459077	18	25SI and 26SI
10459137	10459064	18	25SI and 26SI
10459138	10459079	22	30SI
10459139	10459021	46	JB Series
10459140	10459022	46	JB Series
10459148	10459076	18	25SI and 26SI
10459149	10459009	22	30SI
10459150	10459258	22	30SI
10459151	1117746	22	30SI
10459152	10463073	20	27SI
10459153	10459244	20	27SI
10459194	10459144	23	33SI
10459195	10459141	23	33SI
10459196	10459196	23	33SI
10459197	10459145	24	34SI QUAD Mount
10459198	10459206	24	34SI QUAD Mount
10459199	10459199	24	34SI QUAD Mount
10459207	10459120	22	30SI
10459208	10459081	46	JB Series
10459278	10459278	24	34SI PAD Mount
10459279	10459279	24	34SI PAD Mount
10459287	10459287	24	34SI QUAD Mount
10459288	10459288	24	34SI PAD Mount
10459328	10459279	24	34SI PAD Mount
10459330	10459288	24	34SI PAD Mount
10459340	10459321	16	22SI PAD Mount
10459341	10459320	16	22SI PAD Mount
10459342	10459318	16	22SI PAD Mount
10459345	19020501	7	10SI
10459368	10459368	22	30SI
10459372	10459372	16	23SI
10459457	10459457	14	21SI
10461178	10461045	89	40MT
10461179	10461047	89	40MT
10461182	10461333	91	41MT
10461197	10461209	84	37MT
10461199	10461069	84	37MT

INTERCHANGE

Part Number	Reman Number	Pg	Series
<i>Detroit Diesel (cont.)</i>			
10461200	10461010	84	37MT
10461201	10461130	84	37MT
10461384	10461304	91	41MT
10461385	10461169	83	37MT
10461386	10461171	91	41MT
10461387	10461209	83	37MT
10463648	10459343	7	10SI
R0459108	10459008	21	30SI
R0459109	10459013	13	21SI
R0459111	10459037	13	21SI
R0459114	10459299	26	50DN Belt Drive
R0459129	10459121	27	50DN Gear Drive
R0459130	10459123	26	50DN Belt Drive
R0459131	10459122	27	50DN Gear Drive
R0459132	10459065	18	25SI and 26SI
R0459133	10459051	13	21SI
R0459134	10459013	13	21SI
R0459135	10459037	13	21SI
R0459136	10459077	18	25SI and 26SI
R0459137	10459064	18	25SI and 26SI
R0459138	10459079	21	30SI
R0459139	10459021	46	JB Series
R0459140	10459022	46	JB Series
R0459148	10459076	18	25SI and 26SI
R0459149	10459009	21	30SI
R0459150	10459258	22	30SI
R0459151	1117746	22	30SI
R0459152	10463073	20	27SI
R0459153	10459244	20	27SI
R0459194	10459144	23	33SI
R0459195	10459141	23	33SI
R0459196	10459196	23	33SI
R0459197	10459145	23	34SI QUAD Mount
R0459198	10459206	23	34SI QUAD Mount
R0459199	10459199	23	34SI QUAD Mount
R0459278	10459278	24	34SI PAD Mount
R0459279	10459279	24	34SI PAD Mount
R0459287	10459287	23	34SI QUAD Mount
R0459288	10459288	24	34SI PAD Mount
R0459328	10459279	24	34SI PAD Mount
R0459330	10459288	24	34SI PAD Mount
R0459340	10459320	16	22SI PAD Mount
R0459341	10459320	16	22SI PAD Mount
R0459342	10459318	16	22SI PAD Mount
R0459343	19020501	7	10SI
R0459368	10459368	22	30SI
R0459372	10459372	16	23SI
R0459457	10459457	13	21SI
R0461125	10461057	99	50MT
R0461125	10461057	99	50MT
R0461126	10461052	95	42MT
R0461126	10461052	95	42MT
R0461127	10461053	95	42MT
R0461127	10461053	95	42MT
R0461129	10461056	99	50MT
R0461129	10461056	99	50MT
R0461132	10461132	95	42MT
R0461132	10461132	95	42MT
R0461168	10461132	95	42MT
R0461168	10461132	95	42MT
R0461178	10461045	89	40MT
R0461179	10461047	89	40MT
R0461182	10461333	91	41MT
R0461183	10461055	95	42MT
R0461183	10461055	95	42MT
R0461184	10461054	95	42MT

Part Number	Reman Number	Pg	Series
<i>Detroit Diesel (cont.)</i>			
R0461184	10461054	95	42MT
R0461185	10461075	95	42MT
R0461185	10461075	95	42MT
R0461194	10461133	95	42MT
R0461194	10461133	95	42MT
R0461197	10461225	83	37MT
R0461199	10461069	83	37MT
R0461200	10461010	83	37MT
R0461201	10461130	83	37MT
R0461206	10461233	95	42MT
R0461206	10461233	95	42MT
R0461217	10461134	95	42MT
R0461217	10461134	95	42MT
R0461339	10461341	95	42MT
R0461339	10461341	95	42MT
R0461384	10461304	91	41MT
R0461385	10461169	83	37MT
R0461386	10461171	91	41MT
R0461387	10461209	83	37MT
R0461446	10461446	80	28MT
R0461446	10461446	80	28MT
R0463648	10459343	7	10SI
R0465406	10461446	80	28MT
R0465406	10461446	80	28MT
R0465407	10465043	80	28MT
R0465407	10465043	80	28MT
R0465408	10465239	80	28MT
R0465408	10465239	80	28MT
R0469129	10459121	27	50DN Gear Drive
R9020500	10459343	7	10SI
<i>Dixie</i>			
A-129	10459064	18	25SI and 26SI
A-142	19020501	8	10SI
A-158	10459572	30	Generator
A-166	10463072	20	27SI
A-166	10463073	20	27SI
A-167	10463072	20	27SI
A-168	10459016	22	30SI
A-173	10459244	20	27SI
A-175	10463074	20	27SI
A-176	10459452	20	27SI
A-177	19020504	20	27SI
A-184	19020501	8	10SI
A-190	10459010	22	30SI
A-214	10459363	39	Ford
A-215	10459525	40	Ford
A-217	10459589	42	Ford
A-217	10463449	43	Ford
A-219	10459364	40	Ford Blue Back
A-221	10459546	41	Ford
A-221	10459550	41	Ford
A-276	10459585	38	Ford 6G
A-277	10459586	38	Ford 6G
A-303	10459583	36	Chrysler
A-354	10459518	36	Chrysler
A-717	10459569	48	Leece Neville
A-720	10459021	46	JB Series
A-720	10459022	46	JB Series
A-720	10459080	46	JB Series
A-721	10459458	46	JB Series
A-732	10459567	47	Leece Neville
A-732	10459568	48	Leece Neville
A-754	10459081	46	JB Series
A-761	10459545	47	Leece Neville
A-890	10459519	68	Nippondenso

Part Number	Reman Number	Pg	Series
<i>Dixie (cont.)</i>			
A-919	10459570	56	Motorola
A-921	10459528	50	Motorola
A-924	10459531	51	Motorola
A-927	10459530	51	Motorola
A-927	19020520	60	Motorola
A-953	10459536	52	Motorola
A-976	10459542	54	Motorola
A-988	19020509	57	Motorola
A-1100	19020504	20	27SI
A-1101	10459076	18	25SI and 26SI
A-1102	10459325	22	30SI
A-1103	1117746	22	30SI
A-1104	19020526	8	10SI
A-1105	19020500	8	10SI
A-1106	19020500	8	10SI
A-1114	19020525	8	10SI
A-1115	19020500	8	10SI
A-1116	19020527	8	10SI
A-1117	10459319	11	20SI
A-1118	10459020	11	20SI
A-1118	10459252	11	20SI
A-1131	19020501	8	10SI
A-1132	19020500	8	10SI
A-1132	19020501	8	10SI
A-1133	19020501	8	10SI
A-1137	19020501	8	10SI
A-1139	19020501	8	10SI
A-1139	19020501	8	10SI
A-1150	19020506	10	15SI
A-1151	19020506	10	15SI
A-1153	19020506	10	15SI
A-1160	10463161	20	27SI
A-1167	10459238	20	27SI
A-1193	10459245	18	25SI and 26SI
A-1213	19020505	9	12SI
A-1225	10459338	9	12SI
A-1243	10459069	20	27SI
A-1246	10459350	9	12SI
A-1250	10459367	10	15SI
A-1296	10459064	18	25SI and 26SI
A-1329	10459009	22	30SI
A-1329	10459368	22	30SI
A-1331	10459065	18	25SI and 26SI
A-1331	10459067	18	25SI and 26SI
A-1331	10459077	18	25SI and 26SI
A-1332	10459004	22	30SI
A-1332	10459008	22	30SI
A-1332	10459258	22	30SI
A-1339	10459057	22	30SI
A-1341	10459013	14	21SI
A-1342	10459037	14	21SI
A-1350	10459051	14	21SI
A-1353	10459013	14	21SI
A-1354	10459046	14	21SI
A-1355	10459453	14	21SI
A-1358	10459037	14	21SI
A-1359	10459051	14	21SI
A-1360	10459037	14	21SI
A-1360	10459336	14	21SI
A-1440	10459344	8	10SI
A-1450	10459188	15	22SI
A-1451	10459189	15	22SI
A-1452	10459190	15	22SI
A-1455	10459143	23	33SI
A-1455	10459144	23	33SI
A-1456	10459141	23	33SI

INTERCHANGE



Part Number	Reman Number	Pg	Series
Dixie (cont.)			
A-1456	10459142	23	33SI
A-1457	10459196	23	33SI
A-1492	10459204	15	22SI
A-1492	19020308	138	22SI (New)
A-1493	10459212	15	22SI
A-1493	19020309	138	22SI (New)
A-1494	10459205	15	22SI
A-1494	19020310	138	22SI (New)
A-1545	10459187	14	21SI
A-1609	10459468	15	22SI
A-1901	10459298	27	50DN Gear Drive
A-1911	10459124	27	50DN Gear Drive
A-1917	10459121	27	50DN Gear Drive
A-2025	10459587	39	Ford 6G
A-6108	10459520	31	Bosch K1
A-6130	10459522	34	Bosch
A-6185	10459500	30	Bosch K1
A-6216	10459501	31	Bosch K1
A-6226	10459498	32	Bosch N1
A-6236	10459499	30	Bosch K1
A-6237	10459503	33	Bosch N1
A-6238	19020536	32	Bosch K1
A-6249	19020581	36	Bosch
A-6250	19020507	35	Bosch
A-6252	19020508	35	Bosch
A-6255	10459510	33	Bosch N1
A-6323	10459537	35	Bosch
A-8157	10459497	45	Hitachi
A-8253	10459440	63	Nippondenso
A-8269	10459445	65	Nippondenso
A-8282	10459516	67	Nippondenso
A-8284	10459495	66	Nippondenso
A-8309	10459521	68	Nippondenso
A-8311	10459512	49	Mando
A-8314	10461518	112	Nippondenso
A-8396	10459513	49	Mando
A-8447	10459494	66	Nippondenso
A-8449	10459515	67	Nippondenso
A-8490	10459504	49	Mitsubishi
A-8496	10459517	68	Nippondenso
A-8531	10459448	44	Hitachi
A-8596	10461519	112	Nippondenso
A-8781	10459544	69	Nippondenso
A-9105	10459535	52	Motorola
A-9118	10459540	53	Motorola
A-9130	10459571	56	Motorola
A-9160	10459541	53	Motorola
A-9174	10459534	52	Motorola
A-9179	10459533	51	Motorola
A-9204	10459555	55	Motorola
A-9209	19020510	57	Motorola
A-9210	19020515	59	Motorola
A-9211	19020512	58	Motorola
A-9212	19020545	61	Motorola
A-9217	19020546	62	Motorola
A-9219	19020582	62	Motorola
A-9222	10459549	55	Motorola
A-9232	10459548	54	Motorola
A-9233	10459454	50	Motorola
A-9247	19020515	59	Motorola
A-9251	10459539	53	Motorola
G-109	10459581	30	Generator
G-118	10459579	30	Generator
G-119	10459578	30	Generator
G-121	10459580	30	Generator
G-203	10459573	34	Ford

Part Number	Reman Number	Pg	Series
Dixie (cont.)			
MA-505	10459527	69	Prestolite
S-1009	10461700	75	10MT
S-1043	10465419	75	10MT
S-1060	10461624	75	10MT
S-1080	10461697	77	20, 22, 25MT
S-1083	10461047	89	40MT
S-1104	10461059	89	40MT
S-1107	10461045	89	40MT
S-1108	10461073	89	40MT
S-1132	10461046	89	40MT
S-1139	10461107	89	40MT
S-1172	10465154	75	10MT
S-1181	10465153	75	10MT
S-1182	10465152	75	10MT
S-1192	10461061	89	40MT
S-1251	10465158	75	10MT
S-1266	10461698	77	20, 22, 25MT
S-1293	10461056	100	50MT
S-1295	10461079	95	42MT
S-1388	10465155	75	10MT
S-1443	10461625	75	10MT
S-2009	10461705	103	Ford
S-2011	10461712	132	Prestolite
S-2014	10461664	102	Ford
S-5037	10461713	133	Prestolite
S-8018	10461714	122	Nippondenso
S-8022	10461621	103	Hitachi
S-8023	10461715	111	Mitsubishi
S-8033	10461626	114	Nippondenso
S-8074	10461630	115	Nippondenso
S-8081	10461627	114	Nippondenso
S-8086	10461628	115	Nippondenso
S-8089	10465440	123	Nippondenso
S-8097	10461644	116	Nippondenso
S-8098	10461645	117	Nippondenso
S-8124	10465584	130	Nippondenso
S-8143	10461614	108	Mitsubishi
S-8147	10461646	117	Nippondenso
S-8150	10465399	111	Mitsubishi
S-8152	10465442	123	Nippondenso
S-8153	10461632	109	Mitsubishi
S-8154	10461633	109	Mitsubishi
S-8192	10461683	121	Nippondenso
S-8212	10465296	80	28MT
S-8213	10465168	80	28MT
S-8244	10465535	128	Nippondenso
S-8252	10461520	113	Nippondenso
S-8254	10465540	129	Nippondenso
S-8261	10465531	126	Nippondenso
S-8275	10465528	125	Nippondenso
S-8275	10465541	130	Nippondenso
S-8278	10461647	118	Nippondenso
S-8283	10461650	118	Nippondenso
S-8285	10461645	117	Nippondenso
S-8292	10461648	118	Nippondenso
S-8294	10461656	120	Nippondenso
S-8299	10465532	127	Nippondenso
S-8299	10465533	127	Nippondenso
S-8305	10461655	120	Nippondenso
S-8309	10465437	105	Hitachi
S-8315	10465438	105	Hitachi
S-8316	10465444	124	Nippondenso
S-8316	10465445	124	Nippondenso
S-8325	10461641	110	Mitsubishi
S-8396	10461651	110	Mitsubishi
S-8423	10461498	108	Mitsubishi

Part Number	Reman Number	Pg	Series
Dixie (cont.)			
S-8470	10461657	120	Nippondenso
S-8488	10461659	104	Hitachi
S-8489	10461640	115	Nippondenso
S-8500	10461652	119	Nippondenso
S-8505	10461658	121	Nippondenso
S-8543	10465534	127	Nippondenso
S-8544	10465530	126	Nippondenso
S-8642	10461642	116	Nippondenso
S-8643	10465536	128	Nippondenso
S-8650	10461653	119	Nippondenso
S-8679	10461521	113	Nippondenso
S-8727	10461497	107	Mitsubishi
S-8788	10465440	123	Nippondenso
S-8790	10465529	125	Nippondenso
S-8810	10461643	116	Nippondenso
TG-59	10459575	30	Generator
TG-59	10459576	30	Generator
TG-112	10459574	30	Generator
TG-126	10459577	30	Generator
TS-1004	10461696	76	10MT
TS-1014	10461668	76	10MT
TS-1036	10461598	77	20, 22, 25MT
TS-1048	10461671	76	10MT
TS-1051	10461701	76	10MT
TS-1061	10461057	100	50MT
TS-1061	10461382	100	50MT
TS-1087	10461613	76	10MT
TS-1088	10461615	77	20, 22, 25MT
TS-1126	10461649	76	10MT
TS-1153	10461612	76	10MT
TS-1160	1990210	89	40MT
TS-1161	10461606	76	10MT
TS-1168	10461669	76	10MT
TS-1172	10461600	76	10MT
TS-1177	10461060	90	40MT
TS-1191	10461071	90	40MT
TS-1191	10461131	95	42MT
TS-1195	10461616	77	20, 22, 25MT
TS-1207	1109792	100	50MT
TS-1226	10461599	76	10MT
TS-1227	10461597	76	10MT
TS-1239	10461605	76	10MT
TS-1242	10461611	76	10MT
TS-1245	10461620	76	10MT
TS-1252	10461407	100	50MT
TS-1262	10461677	76	10MT
TS-1267	10465149	78	27MT
TS-1268	10461159	100	50MT
TS-1268	10461161	100	50MT
TS-1283	10461603	76	10MT
TS-1294	10461609	77	20, 22, 25MT
TS-1298	10461159	100	50MT
TS-1298	10461161	100	50MT
TS-1306A	10465060	76	10MT
TS-1308	10461678	77	20, 22, 25MT
TS-1308	10465347	78	27MT
TS-1322	10461617	76	10MT
TS-1326	10461629	76	10MT
TS-1327	1114786	90	40MT
TS-1331	10461602	77	20, 22, 25MT
TS-1366	10465411	76	10MT
TS-1377	10461661	76	10MT
TS-1388	10461499	100	50MT
TS-1436	10465315	80	28MT
TS-1452	1109555	100	50MT
TS-1500	10461050	95	42MT

Part Number	Reman Number	Pg	Series
Dixie (cont.)			
TS-1501	10461052	95	42MT
TS-1501	10461591	95	42MT
TS-1502	10461358	95	42MT
TS-1502	10461025	95	42MT
TS-1503	10461358	95	42MT
TS-1503	10461054	95	42MT
TS-1503	10461068	96	42MT
TS-1504	10461010	83	37MT
TS-1504	10461051	96	42MT
TS-1505	10461077	96	42MT
TS-1506	10461132	96	42MT
TS-1509	10461413	96	42MT
TS-1512	10461055	96	42MT
TS-1512	10461096	96	42MT
TS-1512	10461585	96	42MT
TS-1534	10461303	83	37MT
TS-1534	10461084	84	37MT
TS-1534	10461209	84	37MT
TS-1536	10461301	84	37MT
TS-1538	10461302	84	37MT
TS-1539	10461066	84	37MT
TS-1539	10461089	84	37MT
TS-1539	10461209	84	37MT
TS-1541	10461089	84	37MT
TS-1545	10461016	84	37MT
TS-1547	10461069	84	37MT
TS-1547	10461108	84	37MT
TS-1548	10461015	84	37MT
TS-1551	10461044	84	37MT
TS-1551	10461058	84	37MT
TS-1557	10465410	76	10MT
TS-1559	10465158	76	10MT
TS-1560	10461130	84	37MT
TS-1561	10461058	84	37MT
TS-1563	10461001	84	37MT
TS-1566	10461456	84	37MT
TS-1567	10461010	84	37MT
TS-1568	10461013	84	37MT
TS-1569	10461132	96	42MT
TS-1570	10461351	96	42MT
TS-1570	10461134	96	42MT
TS-1571	10461137	96	42MT
TS-1572	10461450	80	28MT
TS-1573	10465315	80	28MT
TS-1574	10461443	80	28MT
TS-1575	10461445	80	28MT
TS-1576	10465295	80	28MT
TS-1578	10465043	80	28MT
TS-1579	10461446	80	28MT
TS-1580	10461448	80	28MT
TS-1581	10461452	80	28MT
TS-1582	10461070	78	27MT
TS-1582	10465239	80	28MT
TS-1584	10461487	80	28MT
TS-1596	10461382	100	50MT
TS-1597	10461020	96	42MT
TS-1602	10461468	80	28MT
TS-1603	10461053	96	42MT
TS-1604	10461075	96	42MT
TS-1605	10461078	96	42MT
TS-1606	10461169	84	37MT
TS-1607	10461098	84	37MT
TS-1608	10461110	84	37MT
TS-1609	10461098	84	37MT
TS-1610	10461209	84	37MT
TS-1611	10461233	96	42MT

Part Number	Reman Number	Pg	Series
Dixie (cont.)			
TS-1612	10461141	96	42MT
TS-1613	10461056	100	50MT
TS-1614	10461406	100	50MT
TS-1615	10461160	100	50MT
TS-1616	10461160	100	50MT
TS-1616	10461167	100	50MT
TS-1617	10465409	76	10MT
TS-1618	10461485	80	28MT
TS-1619	10461461	80	28MT
TS-1620	10461460	80	28MT
TS-1621	10465365	80	28MT
TS-1622	10461486	80	28MT
TS-1623	10461484	80	28MT
TS-1624	10461459	80	28MT
TS-1625	10465151	80	28MT
TS-1626	10465150	80	28MT
TS-1627	10465348	80	28MT
TS-1631	10465352	76	10MT
TS-1633	10465349	80	28MT
TS-1634	10461299	84	37MT
TS-1635	10461170	84	37MT
TS-1639	10461453	80	28MT
TS-1640	10461444	80	28MT
TS-1641	10461464	80	28MT
TS-1642	10461465	80	28MT
TS-1644	10461463	80	28MT
TS-1645	10461471	80	28MT
TS-1646	10461482	80	28MT
TS-1647	10461467	80	28MT
TS-1649	10461466	80	28MT
TS-1650	10461409	91	41MT
TS-1651	10461240	91	41MT
TS-1652	10461171	91	41MT
TS-1653	10461333	91	41MT
TS-1660	10461472	80	28MT
TS-1681	10461282	91	41MT
TS-1682	10461431	91	41MT
TS-2000	10461663	102	Ford
TS-2001	10461706	103	Ford
TS-4014	10461623	106	Lucas
TS-4018	10461631	106	Lucas
TS-4030	10461635	107	Lucas
TS-5000	10461711	132	Prestolite
TS-5007	10461680	130	Prestolite
TS-5007	10461681	131	Prestolite
TS-5058	10461709	131	Prestolite
TS-5068	10461710	132	Prestolite
TS-5069	10461682	131	Prestolite
TS-6010	10461622	100	Bosch
TS-6022	10461637	101	Bosch
TS-6051	10461638	101	Bosch
TS-6145	10461639	101	Bosch
TS-6146	10461622	100	Bosch
Ford			
87HU10300AA	10459364	40	Ford Blue Back
8N11001	10461663	102	Ford
9N11001	10461663	102	Ford
9N11002	10461663	102	Ford
B5C11002	10461705	103	Ford
B5CF11002C	10459554	102	Ford
C3NF11001A	10461705	103	Ford
C3NF11001C	10461706	103	Ford
C3NF11002D	10461705	103	Ford
C4TZ1002A	10459573	41	Ford
C5NF11001B	10461664	102	Ford

Part Number	Reman Number	Pg	Series
Ford (cont.)			
C7NF11001B	10461664	102	Ford
D0NF11001A	10461664	102	Ford
D1NN11001A	10461664	102	Ford
D2FZ10346B	10463449	43	Ford
D2OZ10346B	10463449	43	Ford
D3HF10300AA	10459363	39	Ford
D3VY10346A	10459546	41	Ford
D4HF10300BA	10459363	39	Ford
D4HF10346BA	10459363	39	Ford
D4HZ10346B	10459363	39	Ford
D4OZ10346D	10463449	43	Ford
D5OF10300CA	10463449	43	Ford
D5ZF10300BA	10459588	42	Ford
D7NN11001A	10461664	102	Ford
D7OF10300BA	10459588	42	Ford
D7UF10300AA	10463449	43	Ford
D7UF10300CA	10459588	42	Ford
D7VZ10346A	10459546	41	Ford
D9AF10300CA	10459589	42	Ford
D9HT10300EA	10459525	40	Ford
E1AF10300DA	10459589	42	Ford
E2HF10346BA	10459364	40	Ford Blue Back
E2HT10300AA	10459364	40	Ford Blue Back
E2HT10300EB	10459364	40	Ford Blue Back
E2HT10300GA	10459364	40	Ford Blue Back
E5TF11000AA	10465399	111	Mitsubishi
E5TZ11002B	10465399	111	Mitsubishi
E79F10300BA	10459584	42	Ford
E7DF10300EB	10459546	41	Ford
E7SF10300FA	19020565	37	Ford 3G
E7UF10300AA	10459589	42	Ford
E7VF10300AA	10459546	41	Ford
E7VF10300BA	10459546	41	Ford
E8TF11000AA	10465399	111	Mitsubishi
E8TZ11002A	10465399	111	Mitsubishi
E99F10300BA	10459584	42	Ford
EZHT10346CA	10459364	40	Ford Blue Back
EZHT10346EB	10459588	42	Ford
F0HU10346CA	10459364	40	Ford Blue Back
F0HU10346FA	10459364	40	Ford Blue Back
F2PU10300DE	10459553	37	Ford 3G
F2UU10300DC	10459553	37	Ford 3G
F37U10300AA	10459552	37	Ford 3G
F5UU10300AA	10459552	37	Ford 3G
F5UU10300BA	10459552	37	Ford 3G
F81U10300CC	10459585	38	Ford 6G
F81U10300DB	10459586	38	Ford 6G
F81U10300DC	10459586	38	Ford 6G
F81U10300EB	10459502	38	Ford 6G
F81U10300GA	10459587	39	Ford 6G
F81Z10346CA	10459585	38	Ford 6G
F81Z10346DA	10459586	38	Ford 6G
F81Z10346EA	10459502	38	Ford 6G
F81Z10346GA	10459587	39	Ford 6G
FAC10002A	10459524	40	Ford
FAC11002B	10461705	103	Ford
FAC11002G	10461705	103	Ford
FOUU10300AA	10459550	41	Ford
FOUU10300BA	10459550	41	Ford
F3TU11000AA	10465399	111	Mitsubishi
F4PU1100AA	10461497	107	Mitsubishi
F4TZ11002A	10461498	108	Mitsubishi
F4TZ11002B	10461497	107	Mitsubishi
F5TU11000AA	10461498	108	Mitsubishi
F5TU11000AB	10461498	108	Mitsubishi
F5TU11000AD	10461498	108	Mitsubishi

Part Number	Reman Number	Pg	Series
Ford (cont.)			
SA-546	10461663	102	Ford
SA-640	10461664	102	Ford
Hitachi			
LR140-714B	10459496	45	Hitachi
LR170-418	10459448	44	Hitachi
LR170-418B	10459448	44	Hitachi
LR180-410H	10459437	43	Hitachi
LR180-503C	10459466	44	Hitachi
LR180-509C	10459467	45	Hitachi
LR180-509R	10459447	44	Hitachi
LR180-510	10459435	43	Hitachi
LT120-07	10459497	45	Hitachi
S13-294	10461659	104	Hitachi
S13-84	10465437	105	Hitachi
S13-84A	10465437	105	Hitachi
S13-84B	10465437	105	Hitachi
S13-89A	10465438	105	Hitachi
S13-89B	10465438	105	Hitachi
S13-89C	10465438	105	Hitachi
S13-89D	10465438	105	Hitachi
S13-94	10461659	104	Hitachi
S13-94A	10461659	104	Hitachi
S13-211	10465438	105	Hitachi
S13-289	10465438	105	Hitachi
S13-289A	10465438	105	Hitachi
S114-443	10461660	104	Hitachi
S114-443A	10461660	104	Hitachi
S114-55	10461621	103	Hitachi
S114-653B	10461660	104	Hitachi
S114-87	10461621	103	Hitachi
S114-87K	10461621	103	Hitachi
S114-87L	10461621	103	Hitachi
S114-87N	10461621	103	Hitachi
S114-87P	10461621	103	Hitachi
Isuzu			
2-90276-800-0	10459435	43	Hitachi
2-90276-810-0	10459447	44	Hitachi
2-91123-212-0	10459441	64	Nippondenso
2-91123-214-0	10459443	64	Nippondenso
2-91123-420-0	10461521	113	Nippondenso
2-91123-932-0	10459444	65	Nippondenso
2-91123-950-0	10459442	64	Nippondenso
2-91255-900-0	10461518	112	Nippondenso
2-91255-902-0	10461520	113	Nippondenso
2-91255-908-0	10461519	112	Nippondenso
2-91255-920-0	10459440	63	Nippondenso
2-91255-922-0	10459439	63	Nippondenso
2-91255-924-0	10459465	66	Nippondenso
2-91255-926-0	10459445	65	Nippondenso
2-91276-024-0	10459437	43	Hitachi
2-91276-300-0	10459466	44	Hitachi
8-97116-697-3	10459467	45	Hitachi
8-97147-778-1	10461527	113	Nippondenso
8-97189-650-0	10459447	44	Hitachi
8-97500-342-0	10459436	63	Nippondenso
Komatsu			
ALT1001	10459351	8	10SI
ALT1002	19020500	8	10SI
ALT1003	10459366	10	15SI
ALT1004	10459319	11	20SI
ALT1005	10459077	18	25SI and 26SI
ALT1006	10459064	18	25SI and 26SI
ALT1007	10459076	18	25SI and 26SI

Part Number	Reman Number	Pg	Series
Komatsu (cont.)			
ALT1009	10459244	20	27SI
ALT1010	10459057	22	30SI
ALT1011	10459120	22	30SI
ALT1017	10459076	18	25SI and 26SI
ALT1018	10459067	18	25SI and 26SI
ALT1022	10461235	14	21SI
ALT1023	10459461	14	21SI
ALT1025	10459306	15	22SI
Leece Neville			
2300JB	10459080	46	JB Series
2500JB	10459021	46	JB Series
2600JB	10459022	46	JB Series
2670LC	10459458	46	JB Series
2700JB	10459458	46	JB Series
2800JB	10459459	46	JB Series
2805J	10459081	46	JB Series
7014AA	10459569	48	Leece Neville
7024AA	10459569	48	Leece Neville
7501A	10459567	47	Leece Neville
7501AA	10459567	47	Leece Neville
7601A	10459568	48	Leece Neville
7601AA	10459568	48	Leece Neville
7603A	10459568	48	Leece Neville
7603AA	10459568	48	Leece Neville
7604A	10459568	48	Leece Neville
7604AA	10459568	48	Leece Neville
7711J	10459545	47	Leece Neville
7711JA	10459545	47	Leece Neville
90762	10459545	47	Leece Neville
110555N	19020309	138	22SI (New)
A001090600	10459569	48	Leece Neville
A001090762	10459545	47	Leece Neville
A200099129	10459569	48	Leece Neville
RJ2500	10459022	46	JB Series
RJ2526	10459022	46	JB Series
RJ2600	10459022	46	JB Series
RJ2670	10459458	46	JB Series
RJ2700	10459458	46	JB Series
RJ2800	10459459	46	JB Series
RJ2805	10459081	46	JB Series
Lester			
3109	10461663	102	Ford
3123	10461705	103	Ford
3136	10461706	103	Ford
3139	10461664	102	Ford
3460	10461713	133	Prestolite
5246	10461680	130	Prestolite
5246	10461681	131	Prestolite
5384	10461712	132	Prestolite
5450	10461711	132	Prestolite
5494	10461710	132	Prestolite
5613	10461709	131	Prestolite
5750	10461682	131	Prestolite
5799	10459524	40	Ford
5838	10459573	41	Ford
7007	10459583	36	Chrysler
7069	10459363	39	Ford
7078	10459525	40	Ford
7317	10459527	69	Prestolite
7344	19020546	62	Motorola
7353	10459570	56	Motorola
7356	10459528	50	Motorola
7357	10459529	50	Motorola
7361	10459530	51	Motorola

Part Number	Reman Number	Pg	Series
Lester (cont.)			
7365	10459531	51	Motorola
7374	10459533	51	Motorola
7376	10459534	52	Motorola
7377	10459535	52	Motorola
7378	10459571	56	Motorola
7380	10459536	52	Motorola
7444	19020509	57	Motorola
7454	10459539	53	Motorola
7458	10459540	53	Motorola
7471	10459541	53	Motorola
7473	10459542	54	Motorola
7483	10459543	54	Motorola
7485	19020544	61	Motorola
7486	19020543	60	Motorola
7486	19020510	57	Motorola
7489	19020582	62	Motorola
7552	10459518	36	Chrysler
7566	19020545	61	Motorola
7625	10459569	48	Leece Neville
7638	10459567	47	Leece Neville
7637	10459568	48	Leece Neville
7768	10459552	37	Ford 3G
7772	10459545	47	Leece Neville
7796	10459502	38	Ford 6G
7797	10459586	38	Ford 6G
7798	10459585	38	Ford 6G
7799	10459587	39	Ford 6G
8045	10459548	54	Motorola
8047	10459549	55	Motorola
8059	10459454	50	Motorola
8070	19020308	138	22SI (New)
8073	19020309	138	22SI (New)
8076	19020310	138	22SI (New)
12061	10459494	66	Nippondenso
12066	10459495	66	Nippondenso
12066	10459441	64	Nippondenso
12075	10459504	49	Mitsubishi
12097	10459448	44	Hitachi
12082	10459445	65	Nippondenso
12112	10459496	45	Hitachi
12128	10459497	45	Hitachi
12131	10459498	32	Bosch N1
12145	10459499	30	Bosch K1
12146	10459500	30	Bosch K1
12147	10459501	31	Bosch K1
12148	19020536	32	Bosch K1
12149	10459503	33	Bosch N1
12157	10459505	33	Bosch
12158	10459506	31	Bosch K1
12159	10459508	34	Bosch
12162	10459510	33	Bosch N1
12166	10459511	34	Bosch
12174	10459512	49	Mando
12175	10459513	49	Mando
12184	10459515	67	Nippondenso
12187	10459516	67	Nippondenso
12195	10459517	68	Nippondenso
12223	19020507	35	Bosch
12224	19020508	35	Bosch
12225	19020581	36	Bosch
12295	19020535	32	Bosch K1
13143	10459519	68	Nippondenso
13193	10459520	31	Bosch K1
13301	10459507	67	Nippondenso
13304	10459532	69	Nippondenso
13766	10459544	69	Nippondenso

Part Number	Reman Number	Pg	Series
Lester (cont.)			
13881	10459537	35	Bosch
14510	10459521	68	Nippondenso
14736	10459444	65	Nippondenso
14737	10459440	63	Nippondenso
14949	10459522	34	Bosch
16203	10461715	111	Mitsubishi
16211	10461621	103	Hitachi
16218	10461714	122	Nippondenso
16563	10461622	100	Bosch
16608	10461623	106	Lucas
16635	10461626	114	Nippondenso
16644	10461627	114	Nippondenso
16655	10461628	115	Nippondenso
16657	10465440	123	Nippondenso
16658	10461630	115	Nippondenso
16664	10461631	106	Lucas
16739	10465442	123	Nippondenso
16790	10461683	121	Nippondenso
16794	10461632	109	Mitsubishi
16795	10461633	109	Mitsubishi
16853	10461608	108	Mitsubishi
16854	10461614	108	Mitsubishi
16881	10461520	113	Nippondenso
16882	10461519	112	Nippondenso
16984	10461635	107	Lucas
16990	10465532	127	Nippondenso
16990	10465533	127	Nippondenso
17037	10465399	111	Mitsubishi
17075	10461637	101	Bosch
17077	10461638	101	Bosch
17088	10465437	105	Hitachi
17095	10461639	101	Bosch
17098	10461640	115	Nippondenso
17110	10461641	110	Mitsubishi
17117	10465444	124	Nippondenso
17199	10461642	116	Nippondenso
17215	10465535	128	Nippondenso
17250	10461643	116	Nippondenso
17306	10461518	112	Nippondenso
17348	10461644	116	Nippondenso
17353	10461645	117	Nippondenso
17354	10461646	117	Nippondenso
17362	10461647	118	Nippondenso
17367	10465531	126	Nippondenso
17371	10461648	118	Nippondenso
17373	10465445	124	Nippondenso
17375	10465445	124	Nippondenso
17391	10461650	118	Nippondenso
17437	10461651	110	Mitsubishi
17458	10461652	119	Nippondenso
17462	10461653	119	Nippondenso
17548	10465530	126	Nippondenso
17577	10461497	107	Mitsubishi
17578	10461498	108	Mitsubishi
17600	10465528	128	Nippondenso
17606	10465529	125	Nippondenso
17613	10461655	120	Nippondenso
17618	10461656	120	Nippondenso
17626	10461657	120	Nippondenso
18008	10461658	121	Nippondenso
18051	10461659	104	Hitachi
18055	10461660	104	Hitachi
18067	10465438	105	Hitachi
18136	10461521	113	Nippondenso
7072-3	10459589	42	Ford
7072-9	19020565	37	Ford 3G

Part Number	Reman Number	Pg	Series
Lester (cont.)			
7072-9	10463449	43	Ford
7074-9	10459588	42	Ford
7705-12	10459546	41	Ford
7705-3	10459550	41	Ford
7735-10	10459584	42	Ford
7756-3	10459553	37	Ford 3G
Lucas			
26167	10461631	106	Lucas
26278	10461631	106	Lucas
26336	10461635	107	Lucas
26428	10461635	107	Lucas
26433	10461635	107	Lucas
27413	10461631	106	Lucas
27508	10461635	107	Lucas
27556	10461635	107	Lucas
27575	10461635	107	Lucas
26211A	10461623	106	Lucas
26278A	10461631	106	Lucas
26278H	10461631	106	Lucas
26428A	10461635	107	Lucas
Mando			
AR150AA	10459512	49	Mando
AR150DA	10459513	49	Mando
AC155513	10459513	49	Mando
AR150CA	10459513	49	Mando
Midland			
RA110000X	19020500	8	10SI
RA110001X	19020525	8	10SI
RA110010X	19020501	8	10SI
RA110015X	19020500	8	10SI
RA110016X	19020500	8	10SI
RA112010X	19020505	9	12SI
RA121000X	10459013	14	21SI
RA121001X	10459037	14	21SI
RA121002X	10459051	14	21SI
RA121008X	10459037	14	21SI
RA121009X	10459013	14	21SI
RA121010X	10459013	14	21SI
RA121011X	10459453	14	21SI
RA121015X	10459013	14	21SI
RA121016X	10459046	14	21SI
RA121017X	10459051	14	21SI
RA121018X	10459013	14	21SI
RA121019X	10459013	14	21SI
RA121020X	10459037	14	21SI
RA121021X	10459051	14	21SI
RA121022X	10459013	14	21SI
RA121023X	10459013	14	21SI
RA121024X	10459037	14	21SI
RA121025X	10459051	14	21SI
RA122000X	10459188	15	22SI
RA122001X	10459189	15	22SI
RA122002X	10459190	15	22SI
RA122003X	10459204	15	22SI
RA122004X	10459212	15	22SI
RA122005X	10459205	15	22SI
RA125002X	10459077	18	25SI and 26SI
RA125003X	10459076	18	25SI and 26SI
RA126001X	10459065	18	25SI and 26SI
RA126002X	10459077	18	25SI and 26SI
RA126003X	10459066	18	25SI and 26SI
RA126004X	10459067	18	25SI and 26SI
RA126005X	10459064	18	25SI and 26SI

Part Number	Reman Number	Pg	Series
Midland (cont.)			
RA126006X	10459076	18	25SI and 26SI
RA126007X	10459161	18	25SI and 26SI
RA127000X	10463072	20	27SI
RA127001X	10463074	20	27SI
RA127002X	10459244	20	27SI
RA127003X	10459238	20	27SI
RA127006X	10463161	20	27SI
RA127007X	10459069	20	27SI
RA127010X	10463073	20	27SI
RA127100X	19020504	20	27SI
RA127101X	19020504	20	27SI
RA130000X	10459009	22	30SI
RA130001X	10459004	22	30SI
RA130002X	10459008	22	30SI
RA130003X	10459010	22	30SI
RA130006X	10459079	22	30SI
RA130007X	10459097	22	30SI
RA130008X	10459057	22	30SI
RA130009X	10459016	22	30SI
RA133001X	10459143	23	33SI
RA133002X	10459144	23	33SI
RA133003X	10459142	23	33SI
RA133004X	10459141	23	33SI
RA134001X	10459145	24	34SI QUAD Mount
RA134002X	10459206	24	34SI QUAD Mount
RA225000X	10459021	46	JB Series
RA226000X	10459022	46	JB Series
RA227000X	10459080	46	JB Series
RA228000X	10459021	46	JB Series
RA401000X	19020543	60	Motorola
RA402002X	19020509	57	Motorola
RA403000X	10459555	55	Motorola
RA403003X	19020510	57	Motorola
RA405005X	19020515	59	Motorola
RA407007X	19020512	58	Motorola
RA501000X	10459363	39	Ford
RA501005X	10459364	40	Ford Blue Back
RA601000X	19020507	35	Bosch
RA601010X	19020508	35	Bosch
RS110002X	10465158	76	10MT
RS110004X	10465158	76	10MT
RS110010X	10465155	76	10MT
RS110011X	10465158	76	10MT
RS110012X	10465154	76	10MT
RS110031X	10465153	76	10MT
RS110033X	10465152	76	10MT
RS110035X	10465352	76	10MT
RS127000X	10465149	78	27MT
RS128000X	10465043	80	28MT
RS128002X	10465365	80	28MT
RS128010X	10465150	80	28MT
RS128011X	10465151	80	28MT
RS128012X	10465168	80	28MT
RS128013X	10465239	80	28MT
RS128014X	10465295	80	28MT
RS128015X	10465296	80	28MT
RS128016X	10465315	80	28MT
RS128017X	10465349	80	28MT
RS128018X	10465348	80	28MT
RS137000X	10461089	84	37MT
RS137001X	10461058	84	37MT
RS137003X	10461069	84	37MT
RS137005X	10461404	84	37MT
RS137010X	10461066	84	37MT
RS137011X	10461084	84	37MT
RS137012X	10461098	84	37MT

INTERCHANGE



Part Number	Reman Number	Pg	Series
Midland (cont.)			
RS137013X	10461110	84	37MT
RS137014X	10461169	84	37MT
RS137015X	10461170	84	37MT
RS137016X	10461108	84	37MT
RS137017X	10461207	84	37MT
RS137018X	10461209	84	37MT
RS137019X	10461130	84	37MT
RS140000X	10461047	90	40MT
RS140001X	10461045	90	40MT
RS140002X	10461046	90	40MT
RS140003X	10461059	90	40MT
RS140005X	10461073	90	40MT
RS140006X	10461107	90	40MT
RS140015X	10461060	90	40MT
RS140022X	10461071	90	40MT
RS142000X	10461068	96	42MT
RS142001X	10461052	96	42MT
RS142002X	10461050	96	42MT
RS142003X	10461133	96	42MT
RS142005X	10461055	96	42MT
RS142006X	10461233	96	42MT
RS142007X	10461053	96	42MT
RS142008X	10461077	96	42MT
RS142015X	10461051	96	42MT
RS142020X	10461050	96	42MT
RS142021X	10461054	96	42MT
RS142022X	10461075	96	42MT
RS142023X	10461078	96	42MT
RS142024X	10461077	96	42MT
RS142025X	10461166	96	42MT
RS142026X	10461096	96	42MT
RS142027X	10461134	96	42MT
RS150001X	1109795	100	50MT
RS150001X	10461407	100	50MT
RS150002X	10461057	100	50MT
RS150003X	1109792	100	50MT
RS150004X	1109793	100	50MT
RS150005X	10461057	100	50MT
RS150010X	10461056	100	50MT
RS150011X	10461159	100	50MT
RS150011X	10461161	100	50MT
RS150012X	10461160	100	50MT
RS150013X	10461161	100	50MT
RS312700X	10465442	123	Nippondenso
RS312800X	10465442	123	Nippondenso
Mitsubishi			
A008TU0091	10459504	49	Mitsubishi
A8TU0091	10459504	49	Mitsubishi
M1T60081	10461651	110	Mitsubishi
M1T60381	10461651	110	Mitsubishi
M1T66081	10461686	110	Mitsubishi
M2T21781	10461632	109	Mitsubishi
M2T21881	10461632	109	Mitsubishi
M2T56181	10461608	108	Mitsubishi
M2T56182	10461608	108	Mitsubishi
M2T57271	10461608	108	Mitsubishi
M2T57771	10461608	108	Mitsubishi
M2T58581	10461641	110	Mitsubishi
M2T58881	10461641	110	Mitsubishi
M2T60171	10461614	108	Mitsubishi
M3T10473	10461633	109	Mitsubishi
M3T10475	10461633	109	Mitsubishi
M3T10476	10461633	109	Mitsubishi
M3T10476D	10461633	109	Mitsubishi
M3T10672	10461715	111	Mitsubishi

Part Number	Reman Number	Pg	Series
Mitsubishi (cont.)			
M3T20681	10461715	111	Mitsubishi
M3T21281	10461632	109	Mitsubishi
M3T21282	10461632	109	Mitsubishi
M3T21781D	10461632	109	Mitsubishi
M3T21882	10461632	109	Mitsubishi
M3T21882A	10461632	109	Mitsubishi
M3T38581	10461632	109	Mitsubishi
M3T38682	10461632	109	Mitsubishi
M3T90071	10465399	111	Mitsubishi
M3T90072	10465399	111	Mitsubishi
M8T50071	10461498	108	Mitsubishi
M8T50171	10461497	107	Mitsubishi
MD072654	10461614	108	Mitsubishi
MD171228	10461641	110	Mitsubishi
Motorola			
812NJD453	10459570	56	Motorola
812NJD454	10459570	56	Motorola
8A62019F	19020520	60	Motorola
8AK2069F	19020520	60	Motorola
8AL2056K	10459535	52	Motorola
8EA2001FA	19020545	61	Motorola
8EK2004DC	19020514	58	Motorola
8EK2005NC	19020512	58	Motorola
8EK2005ND	19020512	58	Motorola
8EK2007NA	19020512	58	Motorola
8EK2010N	19020512	58	Motorola
8EK2010NA	19020512	58	Motorola
8EK2010NB	19020512	58	Motorola
8EM2009	10459549	55	Motorola
8EM2009N	10459549	55	Motorola
8EM2009NA	10459549	55	Motorola
8EM2009NB	10459549	55	Motorola
8EM2009ND	10459549	55	Motorola
8EM2012	19020546	62	Motorola
8EM2012NA	19020546	62	Motorola
8EM3002GA	10459543	54	Motorola
8EM3002GB	10459543	54	Motorola
8EM3002GC	10459543	54	Motorola
8HA2003F	19020509	57	Motorola
8HA2003FS	19020509	57	Motorola
8HA2005K	19020544	61	Motorola
8HA2006F	19020509	57	Motorola
8HA2008FA	19020543	60	Motorola
8HA2009K	19020510	57	Motorola
8HC3010G	10459540	53	Motorola
8LF2055F	10459571	56	Motorola
8LHA2023V	10459555	55	Motorola
8LHA2023VA	10459555	55	Motorola
8LHA205OVA	10459454	50	Motorola
8LHA205OVAS	10459454	50	Motorola
8LHA2070V	10459555	55	Motorola
8LHA2070VA	10459555	55	Motorola
8LHA2070VB	10459555	55	Motorola
8MA2003P	10459542	54	Motorola
8MA2014P	10459533	51	Motorola
8MR2008P	10459534	52	Motorola
8MR2009P	10459534	52	Motorola
8MR2010P	10459534	52	Motorola
8MR2012P	10459534	52	Motorola
8MR2030T	10459548	54	Motorola
8MR2030TS	10459548	54	Motorola
8MR2033T	10459541	53	Motorola
8MR2058P	19020582	62	Motorola
8MR2127LA	19020519	59	Motorola
8MR2175F	19020515	59	Motorola

Part Number	Reman Number	Pg	Series
Motorola (cont.)			
8MR2185L	19020512	58	Motorola
9DB2LG2B58	10459539	53	Motorola
A12N600	10459530	51	Motorola
RA12N451	10459536	52	Motorola
RA12N600D	10459531	51	Motorola
RA12NJD453	10459528	50	Motorola
RA12NJD604	10459529	50	Motorola
Nippondenso			
0128000-0710	10465440	123	Nippondenso
0128000-5730	10465440	123	Nippondenso
021000-6840	10459521	68	Nippondenso
028000-1730	10461714	122	Nippondenso
028000-1740	10461714	122	Nippondenso
028000-2000	10461714	122	Nippondenso
028000-2001	10461714	122	Nippondenso
028000-3290	10461626	114	Nippondenso
028000-3291	10461626	114	Nippondenso
028000-3292	10461626	114	Nippondenso
028000-3970	10461627	114	Nippondenso
028000-3971	10461627	114	Nippondenso
028000-4270	10461714	122	Nippondenso
028000-5250	10461628	115	Nippondenso
028000-5251	10461628	115	Nippondenso
028000-5880	10461630	115	Nippondenso
028000-5881	10461630	115	Nippondenso
028000-5882	10461630	115	Nippondenso
028000-6440	10465442	123	Nippondenso
028000-6780	10461644	116	Nippondenso
028000-6781	10461644	116	Nippondenso
028000-7430	10461645	117	Nippondenso
028000-7431	10461645	117	Nippondenso
028000-7460	10461646	117	Nippondenso
028000-7461	10461646	117	Nippondenso
028000-7462	10461646	117	Nippondenso
028000-7470	10461646	117	Nippondenso
028000-7471	10461646	117	Nippondenso
028000-7790	10465442	123	Nippondenso
028000-7791	10465442	123	Nippondenso
028000-8400	10461647	118	Nippondenso
028000-8401	10461647	118	Nippondenso
028000-8402	10461647	118	Nippondenso
028000-8403	10461647	118	Nippondenso
028000-8404	10461647	118	Nippondenso
028000-8630	10461519	112	Nippondenso
028000-9270	10461683	121	Nippondenso
028000-9570	10461646	117	Nippondenso
100211-0081	10459519	68	Nippondenso
100211-0290	10459519	68	Nippondenso
100211-0291	10459519	68	Nippondenso
100211-0292	10459519	68	Nippondenso
100211-0940	10459494	66	Nippondenso
100211-0980	10459494	66	Nippondenso
100211-1721	10459440	63	Nippondenso
100211-2750	10459445	65	Nippondenso
100211-2760	10459465	66	Nippondenso
100211-4540	10459516	67	Nippondenso
100211-5940	10459443	64	Nippondenso
100211-6020	10459442	64	Nippondenso
100211-6030	10459495	66	Nippondenso
100211-6031	10459495	66	Nippondenso
100211-6050	10459495	66	Nippondenso
100211-6051	10459495	66	Nippondenso
100211-6420	10459517	68	Nippondenso
100211-6930	10459515	67	Nippondenso
100211-6931	10459515	67	Nippondenso

Part Number	Reman Number	Pg	Series
Nippondenso (cont.)			
101211-1733	10459439	63	Nippondenso
101211-6030	10459441	64	Nippondenso
101211-7811	10459436	63	Nippondenso
121000-404	10459507	67	Nippondenso
121000-428	10459544	69	Nippondenso
121000-1680	10459444	65	Nippondenso
121000-4000	10459532	69	Nippondenso
121000-4010	10459532	69	Nippondenso
121000-4030	10459532	69	Nippondenso
121000-4040	10459507	67	Nippondenso
121000-4090	10459532	69	Nippondenso
121000-4100	10459532	69	Nippondenso
121000-4110	10459532	69	Nippondenso
121000-4280	10459544	69	Nippondenso
128000-0020	10465442	123	Nippondenso
128000-0050	10461640	115	Nippondenso
128000-0140	10465531	126	Nippondenso
128000-0141	10465531	126	Nippondenso
128000-0210	10465540	129	Nippondenso
128000-0211	10465540	129	Nippondenso
128000-0212	10465540	129	Nippondenso
128000-0213	10465532	129	Nippondenso
128000-0213	10465540	129	Nippondenso
128000-0480	10461648	118	Nippondenso
128000-0490	10461520	113	Nippondenso
128000-0491	10461520	113	Nippondenso
128000-0540	10465540	129	Nippondenso
128000-0541	10465540	129	Nippondenso
128000-0542	10465540	129	Nippondenso
128000-0543	10465540	129	Nippondenso
128000-0570	10465445	124	Nippondenso
128000-0620	10461683	121	Nippondenso
128000-0622	10461683	121	Nippondenso
128000-0710	10465440	123	Nippondenso
128000-0720	10465444	124	Nippondenso
128000-0721	10465444	124	Nippondenso
128000-0740	10465584	130	Nippondenso
128000-0770	10461626	114	Nippondenso
128000-0771	10461626	114	Nippondenso
128000-0772	10461626	114	Nippondenso
128000-0960	10465442	123	Nippondenso
128000-1250	10461683	121	Nippondenso
128000-1251	10461683	121	Nippondenso
128000-2270	10465540	129	Nippondenso
128000-2280	10465445	124	Nippondenso
128000-2470	10461518	112	Nippondenso
128000-2560	10461650	118	Nippondenso
128000-2561	10461650	118	Nippondenso
128000-2562	10461650	118	Nippondenso
128000-2563	10461650	118	Nippondenso
128000-2880	10465442	123	Nippondenso
128000-2881	10465442	123	Nippondenso
128000-4220	10465528	125	Nippondenso
128000-4340	10461645	117	Nippondenso
128000-4390	10461684	121	Nippondenso
128000-4900	10465529	125	Nippondenso
128000-4910	10465535	118	Nippondenso
128000-5330	10461645	117	Nippondenso
128000-5331	10461645	117	Nippondenso
128000-5590	10461654	119	Nippondenso
128000-5600	10461655	120	Nippondenso
128000-5601	10461655	120	Nippondenso
128000-5970	10461656	120	Nippondenso
128000-5971	10461656	120	Nippondenso
128000-5972	10461656	120	Nippondenso
128000-5973	10461656	120	Nippondenso

Part Number	Reman Number	Pg	Series
Nippondenso (cont.)			
128000-7240	10461657	123	Nippondenso
128000-9500	10465532	127	Nippondenso
128000-9501	10465532	127	Nippondenso
228000-195	10465533	127	Nippondenso
228000-237	10461658	121	Nippondenso
228000-581	10461653	119	Nippondenso
228000-0630	10465534	127	Nippondenso
228000-0631	10465534	127	Nippondenso
228000-1070	10465531	126	Nippondenso
228000-1071	10465531	126	Nippondenso
228000-1750	10465534	127	Nippondenso
228000-1751	10465534	127	Nippondenso
228000-1950	10465533	127	Nippondenso
228000-1951	10465533	127	Nippondenso
228000-1952	10465533	127	Nippondenso
228000-1953	10465533	127	Nippondenso
228000-2290	10465530	126	Nippondenso
228000-2291	10465530	126	Nippondenso
228000-2360	10461656	120	Nippondenso
228000-2370	10461658	121	Nippondenso
228000-2670	10465541	130	Nippondenso
228000-280	10461521	113	Nippondenso
228000-2800	10461521	113	Nippondenso
228000-2804	10461521	113	Nippondenso
228000-3310	10465528	125	Nippondenso
228000-3311	10465528	125	Nippondenso
228000-3320	10465541	130	Nippondenso
228000-3321	10465541	130	Nippondenso
228000-4600	10461656	120	Nippondenso
228000-4601	10461656	120	Nippondenso
228000-5000	10465536	128	Nippondenso
228000-5001	10465536	128	Nippondenso
228000-5050	10465536	128	Nippondenso
228000-5210	10461652	119	Nippondenso
228000-5510	10461643	116	Nippondenso
228000-5620	10465537	128	Nippondenso
228000-5630	10465538	129	Nippondenso
228000-5730	10461642	116	Nippondenso
228000-5731	10461642	116	Nippondenso
228000-5810	10461653	119	Nippondenso
228000-5811	10461653	119	Nippondenso
228000-5900	10465539	129	Nippondenso
228000-6670	10465534	127	Nippondenso
228000-7002	10461527	113	Nippondenso
228000-8510	10461685	122	Nippondenso
9702800-397	10461627	114	Nippondenso
9702800-525	10461628	115	Nippondenso
9702800-840	10461647	118	Nippondenso
9702809-558	10461630	115	Nippondenso
9702809-588	10461630	115	Nippondenso
Prestolite			
110-3	10459530	51	Motorola
110-54	10459536	52	Motorola
110-115	10459534	52	Motorola
110-141	10459542	54	Motorola
110-157	10459531	51	Motorola
110-159	19020509	57	Motorola
110-242	10459548	54	Motorola
110-252	10459541	53	Motorola
110-253	19020544	61	Motorola
110-255	10459555	55	Motorola
110-266	10459534	52	Motorola
110-273	19020520	60	Motorola
110-303	19020510	57	Motorola
110-303	19020543	60	Motorola

Part Number	Reman Number	Pg	Series
Prestolite (cont.)			
110-304	19020510	57	Motorola
110-309	19020582	62	Motorola
110-329	19020545	61	Motorola
110-376	10459543	54	Motorola
110-379	19020546	62	Motorola
110-399	19020514	58	Motorola
110-454	10459454	50	Motorola
110-460	10459539	53	Motorola
110-486	10459543	54	Motorola
110-521	19020582	62	Motorola
110-555	10459555	55	Motorola
110-565	10459555	55	Motorola
110-600	19020512	58	Motorola
110-250	19020308	137	22SI (New)
110-255	19020310	137	22SI (New)
110-255	19020309	137	22SI (New)
110-742	10459539	53	Motorola
110-747	10459539	53	Motorola
110-747A	10459539	53	Motorola
8MR2127LA	19020519	59	Motorola
ALK6207	10459527	69	Prestolite
MBG4140	10461710	132	Prestolite
MBG4141	10461710	132	Prestolite
MDT6013	10461709	131	Prestolite
MDT6013A	10461709	131	Prestolite
MDT6021	10461709	131	Prestolite
MDT6021	10461709	131	Prestolite
MDU6003	10461713	133	Prestolite
MDU6013	10461713	133	Prestolite
MDU7001	10461713	133	Prestolite
MDU-7102	10461680	130	Prestolite
MDU-7102A	10461680	130	Prestolite
MDU-7104	10461681	131	Prestolite
MDU-7104A	10461681	131	Prestolite
MDU-7115	10461682	132	Prestolite
MDU-7115A	10461682	132	Prestolite
ML4358	10461712	132	Prestolite
ML4376	10461712	132	Prestolite
ML4377	10461712	132	Prestolite
MZ4118	10461711	132	Prestolite
MZ4175	10461711	132	Prestolite
MZ4184	10461711	132	Prestolite
MZ4192	10461711	132	Prestolite
MZ4194	10461711	132	Prestolite
Thermo King			
44-1170	10465445	124	Nippondenso
44-3325	19020509	57	Motorola
44-4181	19020544	61	Motorola
44-5004	19020544	61	Motorola
44-5004	19020509	57	Motorola
44-6257	19020543	60	Motorola
44-6257	19020510	57	Motorola
44-6266	19020543	60	Motorola
44-6266	19020510	57	Motorola
44-6981	19020582	62	Motorola
44-7155	19020515	59	Motorola
44-7156	19020512	58	Motorola
44-7924	19020514	58	Motorola
44-7925	19020515	59	Motorola
44-7927	19020512	58	Motorola
44-8091	19020515	59	Motorola
44-8525	19020508	35	Bosch
44-8949	19020508	35	Bosch
44-8904	19020512	58	Motorola
44-8939	19020515	59	Motorola

INTERCHANGE



Part Number	Reman Number	Pg	Series
Thermo King (cont.)			
44-8940	19020512	58	Motorola
44-8950	19020507	35	Bosch
44-9571	19020507	35	Bosch
44-9572	19020508	35	Bosch
44-9750	19020515	59	Motorola
44-9752	19020514	58	Motorola
44-9753	19020512	58	Motorola
44-9755	19020512	55	Motorola
45-267	10465445	124	Nippondenso
45-338	10465445	124	Nippondenso
45-904	10465444	124	Nippondenso
45-1229	10465437	105	Hitachi
45-1229	10465442	123	Nippondenso
45-1251	10465444	124	Nippondenso
45-1263	10465438	105	Hitachi
45-1285	10465437	105	Hitachi
45-1312	10465440	123	Nippondenso
45-1335	10465584	130	Nippondenso
45-1718	10465440	123	Nippondenso
45-5657	10465442	123	Nippondenso
45-5674	10465442	123	Nippondenso
Wilson (cont.)			
90-01-3005	10459246	22	30SI
90-01-3028	10459077	18	25SI and 26SI
90-01-3030	10459064	18	25SI and 26SI
90-01-3031	10459077	18	25SI and 26SI
90-01-3056	19020501	8	10SI
90-01-3056	10459572	30	Generator
90-01-3070	19020504	20	27SI
90-01-3071	10463072	20	27SI
90-01-3071	10463073	20	27SI
90-01-3081	19020500	8	10SI
90-01-3086	10463074	20	27SI
90-01-3091	19020504	20	27SI
90-01-3093	10459009	22	30SI
90-01-3094	10459004	22	30SI
90-01-3094	10459008	22	30SI
90-01-3095	10459016	22	30SI
90-01-3096	10459010	22	30SI
90-01-3098	10459325	22	30SI
90-01-3099	10459076	18	25SI and 26SI
90-01-3100	10459244	20	27SI
90-01-3104	10459452	20	27SI
90-01-3105	19020501	8	10SI
90-01-3105	19020500	8	10SI
90-01-3106	19020501	8	10SI
90-01-3106	19020500	8	10SI
90-01-3107	19020504	20	27SI
90-01-3108	19020504	20	27SI
90-01-3109	19020506	10	15SI
90-01-3111	19020501	8	10SI
90-01-3112	19020501	8	10SI
90-01-3115	10463160	20	27SI
90-01-3116	10463161	20	27SI
90-01-3117	10459238	20	27SI
90-01-3123	19020527	8	10SI
90-01-3127	10459020	11	20SI
90-01-3127	10459252	11	20SI
90-01-3128	19020525	8	10SI
90-01-3129	19020526	8	10SI
90-01-3131	19020500	8	10SI
90-01-3133	19020500	8	10SI
90-01-3134	19020500	8	10SI
90-01-3135	19020500	8	10SI
90-01-3143	19020501	8	10SI

Part Number	Reman Number	Pg	Series
Wilson (cont.)			
90-01-3145	19020505	9	12SI
90-01-3147	10459350	9	12SI
90-01-3151	10459367	9	15SI
90-01-3157	10459319	11	20SI
90-01-3158	10459064	18	25SI and 26SI
90-01-3171	10459338	9	12SI
90-01-3176	10459069	20	27SI
90-01-3178	19020501	8	10SI
90-01-4056	19020500	8	10SI
90-01-4057	10459008	22	30SI
90-01-4057	10459079	22	30SI
90-01-4057	10459097	22	30SI
90-01-4057	10459258	22	30SI
90-01-4058	10459013	14	21SI
90-01-4072	10459051	14	21SI
90-01-4074	10459037	14	21SI
90-01-4077	10459065	18	25SI and 26SI
90-01-4081	10459368	22	30SI
90-01-4083	10459076	18	25SI and 26SI
90-01-4093	10459037	14	21SI
90-01-4093	10459051	14	21SI
90-01-4105	10459013	14	21SI
90-01-4108	19020500	8	10SI
90-01-4109	10459051	14	21SI
90-01-4113	10459013	14	21SI
90-01-4118	10459046	14	21SI
90-01-4119	10459037	14	21SI
90-01-4148	10459065	18	25SI and 26SI
90-01-4154	10459057	22	30SI
90-01-4171	10459064	18	25SI and 26SI
90-01-4172	10459076	18	25SI and 26SI
90-01-4173	10459065	18	25SI and 26SI
90-01-4173	10459067	18	25SI and 26SI
90-01-4173	10459077	18	25SI and 26SI
90-01-4174	10459067	18	25SI and 26SI
90-01-4260	10459143	23	33SI
90-01-4260	10459144	23	33SI
90-01-4262	10459141	23	33SI
90-01-4262	10459142	23	33SI
90-01-4267	10459189	15	22SI
90-01-4267	10459145	24	34SI QUAD Mount
90-01-4268	10459344	8	10SI
90-01-4269	10459188	15	22SI
90-01-4271	10459145	24	34SI QUAD Mount
90-01-4272	10459206	24	34SI QUAD Mount
90-01-4295	19020309	138	22SI (New)
90-01-4296	19020308	138	22SI (New)
90-01-4297	19020310	138	22SI (New)
90-01-4297	10459190	15	22SI
90-02-4051	10459584	42	Ford
90-02-5005	10459573	41	Ford
90-02-5016	10459363	39	Ford
90-02-5020	10459588	42	Ford
90-02-5029	10459525	40	Ford
90-02-5032	10459364	40	Ford Blue Back
90-02-5040	19020565	37	Ford 3G
90-02-5064	10459553	37	Ford 3G
90-02-5065	10459552	37	Ford 3G
90-02-5092	10459502	38	Ford 6G
90-03-2009	10459583	36	Chrysler
90-03-2064	10459518	36	Chrysler
90-04-7017	10459569	48	Leece Neville
90-04-7020	10459022	46	JB Series
90-04-7020	10459022	46	JB Series
90-04-7021	10459022	46	JB Series
90-04-7023	10459567	47	Leece Neville

Part Number	Reman Number	Pg	Series
Wilson (cont.)			
90-04-7023	10459568	48	Leece Neville
90-04-7039	10459458	46	JB Series
90-04-7053	10459545	47	Leece Neville
90-05-9019	10459570	56	Motorola
90-05-9021	10459528	50	Motorola
90-05-9024	10459529	50	Motorola
90-05-9027	10459530	51	Motorola
90-05-9028	19020520	60	Motorola
90-05-9055	10459536	52	Motorola
90-05-9063	10459534	52	Motorola
90-05-9076	10459535	52	Motorola
90-05-9077	10459531	51	Motorola
90-05-9079	10459542	54	Motorola
90-05-9082	19020509	57	Motorola
90-05-9104	10459541	53	Motorola
90-05-9107	10459540	53	Motorola
90-05-9113	10459533	51	Motorola
90-05-9114	10459571	56	Motorola
90-05-9124	10459555	55	Motorola
90-05-9136	19020545	61	Motorola
90-05-9138	19020544	61	Motorola
90-05-9147	19020546	62	Motorola
90-05-9151	19020512	58	Motorola
90-05-9152	19020543	60	Motorola
90-05-9152	19020510	57	Motorola
90-05-9154	10459543	54	Motorola
90-05-9157	10459539	53	Motorola
90-05-9158	10459548	54	Motorola
90-05-9159	10459549	55	Motorola
90-05-9164	19020582	62	Motorola
90-05-9170	19020514	58	Motorola
90-05-9176	10459454	50	Motorola
90-05-9209	19020519	59	Motorola
90-06-1020M	10459527	69	Prestolite
90-15-6094	10459522	34	Bosch
90-15-6164	10459520	31	Bosch K1
90-15-6169	10459498	32	Bosch N1
90-15-6218	10459499	30	Bosch K1
90-15-6230	10459500	30	Bosch K1
90-15-6231	10459510	33	Bosch N1
90-15-6232	10459501	31	Bosch K1
90-15-6233	19020507	35	Bosch
90-15-6236	10459503	33	Bosch N1
90-15-6237	19020536	32	Bosch K1
90-15-6239	10459511	34	Bosch
90-15-6280	19020508	35	Bosch
90-15-6288	19020581	36	Bosch
90-15-6288	19020582	36	Motorola
90-15-6291	10459506	31	Bosch K1
90-15-6295	10459508	34	Bosch
90-15-6298	10459505	33	Bosch
90-15-6310	10459537	35	Bosch
90-25-1016	10459497	45	Hitachi
90-25-1089	10459448	44	Hitachi
90-25-1095	10459496	45	Hitachi
90-27-3135	10459504	49	Mitsubishi
90-27-5095	10459441	64	Nippondenso
90-29-5036	10459519	68	Nippondenso
90-29-5095	10459495	66	Nippondenso
90-29-5096	10459521	68	Nippondenso
90-29-5106	10459440	63	Nippondenso
90-29-5111	10459532	69	Nippondenso
90-29-5112	10459507	67	Nippondenso
90-29-5117	10459445	65	Nippondenso
90-29-5119	10459494	66	Nippondenso
90-29-5181	10459516	67	Nippondenso

Part Number	Reman Number	Pg	Series
Wilson (cont.)			
90-29-5183	10459515	67	Nippondenso
90-29-5296	10459517	68	Nippondenso
90-29-5426	10465539	129	Nippondenso
90-31-7000	10459513	49	Mando
90-31-7001	10459512	49	Mando
90-31-7001	10459555	55	Motorola
91-01-3639	10461696	76	10MT
91-01-3646	10461700	76	10MT
91-01-3659	10461668	76	10MT
91-01-3682	10461625	76	10MT
91-01-3693	10461598	77	20, 22, 25MT
91-01-3700	10461047	90	40MT
91-01-3701	10461045	90	40MT
91-01-3702	10461046	90	40MT
91-01-3703	10461107	90	40MT
91-01-3736	10461624	76	10MT
91-01-3760	10461697	77	20, 22, 25MT
91-01-3767	10461382	100	50MT
91-01-3772	10461045	90	40MT
91-01-3774	10461045	90	40MT
91-01-3787	10461059	90	40MT
91-01-3791	1990220	90	40MT
91-01-3793	10461045	90	40MT
91-01-3799	10461698	77	20, 22, 25MT
91-01-3832	10465153	76	10MT
91-01-3853	10465158	76	10MT
91-01-3865	10465154	76	10MT
91-01-3882	10465155	76	10MT
91-01-3894	10465149	78	27MT
91-01-3926	10465296	80	28MT
91-01-3927	10465168	80	28MT
91-01-3940	10461671	76	10MT
91-01-3942	10461701	76	10MT
91-01-3948	10461057	100	50MT
91-01-3967	10461613	76	10MT
91-01-3968	10461615	77	20, 22, 25MT
91-01-3996	10461649	76	10MT
91-01-4021	10461612	76	10MT
91-01-4024	1990210	90	40MT
91-01-4025	10461606	76	10MT
91-01-4032	10461669	76	10MT
91-01-4036	10461600	76	10MT
91-01-4037	10465347	78	27MT
91-01-4040	10461046	90	40MT
91-01-4050	10461071	90	40MT
91-01-4054	10461616	77	20, 22, 25MT
91-01-4062	1109792	100	50MT
91-01-4074	10461161	100	50MT
91-01-4083	1114786	90	40MT
91-01-4094	10461610	77	20, 22, 25MT
91-01-4096	10461609	77	20, 22, 25MT
91-01-4104	10461045	90	40MT
91-01-4107	10461056	100	50MT
91-01-4108	10461057	100	50MT
91-01-4109	10461407	100	50MT
91-01-4111	1109555	100	50MT
91-01-4131	10461047	90	40MT
91-01-4137	10461047	90	40MT
91-01-4140	10461069	84	37MT
91-01-4140	10461108	84	37MT
91-01-4146	10461015	84	37MT
91-01-4148	10461209	84	37MT
91-01-4151	10461052	96	42MT
91-01-4152	10461077	96	42MT
91-01-4153	10461413	96	42MT
91-01-4154	10461414	96	42MT

Part Number	Reman Number	Pg	Series
Wilson (cont.)			
91-01-4157	10461068	96	42MT
91-01-4158	10461025	96	42MT
91-01-4158	10461358	96	42MT
91-01-4159	10461054	96	42MT
91-01-4159	10461068	96	42MT
91-01-4160	10461133	96	42MT
91-01-4161	10461010	84	37MT
91-01-4161	10461021	96	42MT
91-01-4161	10461050	96	42MT
91-01-4161	10461051	96	42MT
91-01-4161	10461162	96	42MT
91-01-4163	10461010	84	37MT
91-01-4163	10461051	96	42MT
91-01-4165	10461044	84	37MT
91-01-4165	10461058	84	37MT
91-01-4166	10461052	92	42MT
91-01-4166	10461053	92	42MT
91-01-4166	10461164	92	42MT
91-01-4167	10461089	84	37MT
91-01-4167	10461209	84	37MT
91-01-4168	10461044	84	37MT
91-01-4169	10461058	84	37MT
91-01-4176	10461599	76	10MT
91-01-4177	10461597	76	10MT
91-01-4188	10461605	76	10MT
91-01-4191	10461611	76	10MT
91-01-4194	10461620	76	10MT
91-01-4201	10461677	76	10MT
91-01-4203	10461603	76	10MT
91-01-4215	10461678	77	20, 22, 25MT
91-01-4216	10461617	76	10MT
91-01-4219	10461602	77	20, 22, 25MT
91-01-4225	10465158	76	10MT
91-01-4247	10465352	76	10MT
91-01-4248	10461629	76	10MT
91-01-4271	10465315	80	28MT
91-01-4273	10465410	76	10MT
91-01-4274	10465411	76	10MT
91-01-4275	10461070	78	27MT
91-01-4278	10461010	84	37MT
91-01-4281	10465409	76	10MT
91-01-4285	10461089	84	37MT
91-01-4286	10461159	100	50MT
91-01-4287	10461058	84	37MT
91-01-4290	10461137	96	42MT
91-01-4291	10461013	84	37MT
91-01-4295	10461055	96	42MT
91-01-4295	10461096	96	42MT
91-01-4296	10461075	96	42MT
91-01-4297	10461020	96	42MT
91-01-4298	10461358	96	42MT
91-01-4303	10461302	84	37MT
91-01-4304	10461301	84	37MT
91-01-4306	10461066	84	37MT
91-01-4307	10461098	84	37MT
91-01-4309	10461445	80	28MT
91-01-4310	10461450	80	28MT
91-01-4311	10465295	80	28MT
91-01-4312	10461446	80	28MT
91-01-4313	10465043	80	28MT
91-01-4314	10461448	80	28MT
91-01-4315	10465315	80	28MT
91-01-4316	10461452	80	28MT
91-01-4317	10461487	80	28MT
91-01-4330	10461233	96	42MT
91-01-4330	10461079	96	42MT

Part Number	Reman Number	Pg	Series
Wilson (cont.)			
91-01-4331	10461591	96	42MT
91-01-4332	10461001	84	37MT
91-01-4333	10461303	84	37MT
91-01-4334	10461414	96	42MT
91-01-4335	10461299	84	37MT
91-01-4337	10461456	84	37MT
91-01-4339	10461089	84	37MT
91-01-4341	10461300	84	37MT
91-01-4347	10461136	96	42MT
91-01-4349	10461131	96	42MT
91-01-4350	10461132	96	42MT
91-01-4351	10461135	96	42MT
91-01-4353	10461209	84	37MT
91-01-4354	10465150	81	28MT
91-01-4356	10465151	81	28MT
91-01-4357	10461499	100	50MT
91-01-4360	10461239	91	41MT
91-01-4361	10461468	81	28MT
91-01-4362	10461473	81	28MT
91-01-4363	10461484	81	28MT
91-01-4364	10461485	81	28MT
91-01-4365	10461486	81	28MT
91-01-4366	10465365	81	28MT
91-01-4367	10461443	81	28MT
91-01-4368	10461459	81	28MT
91-01-4369	10461460	81	28MT
91-01-4370	10461461	81	28MT
91-01-4371	10465348	81	28MT
91-01-4372	10461412	96	42MT
91-01-4374	10461467	81	28MT
91-01-4375	10465349	81	28MT
91-01-4377	10461444	81	28MT
91-01-4378	10465239	81	28MT
91-01-4381	10461466	81	28MT
91-01-4396	10461169	84	37MT
91-01-4399	10461500	84	37MT
91-01-4400	10461358	96	42MT
91-01-4405	10461133	96	42MT
91-01-4407	10461233	96	42MT
91-01-4409	10461110	84	37MT
91-01-4411	10461078	96	42MT
91-01-4412	10461209	84	37MT
91-01-4413	10461098	84	37MT
91-01-4414	10461483	81	28MT
91-01-4415	10461463	81	28MT
91-01-4416	10461464	81	28MT
91-01-4417	10461453	81	28MT
91-01-4418	10461465	81	28MT
91-01-4419	10461471	81	28MT
91-01-4420	10461055	96	42MT
91-01-4427	10461414	96	42MT
91-01-4428	10461378	100	50MT
91-01-4429	10461016	84	37MT
91-01-4432	10465412	76	10MT
91-01-4436	10461360	96	42MT
91-01-4438	10461161	100	50MT
91-01-4439	10461094	84	37MT
91-01-4460	10461585	96	42MT
91-01-4466	10461304	91	41MT
91-01-4468	10461409	91	41MT
91-01-4469	10461333	91	41MT
91-01-4552	10461472	81	28MT
91-01-4848	10461661	76	10MT
91-02-5783	10461663	102	Ford
91-02-5784	10459554	102	Ford
91-02-5784	10461706	103	Ford

Heavy-Duty Batteries Group 31

Road Gang® Group 31 Heavy-Duty Batteries



HIGH CYCLE BATTERY

This Original Equipment replacement battery is engineered to optimize cranking power, cycling capabilities, vibration resistance and system capacity.

DR31-2150 — Rated at 700 CCA/180 RC, this battery is the ideal choice for line-haul truck, coach, off-road, emergency vehicle, and gasoline powered pick-up and delivery applications.



CRANKING BATTERIES

Two-battery, three-battery or four-battery complements (up to 3600 CCA) meet most engine starting requirements for mid-range diesel, large diesel and gasoline engines in heavy-duty service.

DR31-625 — Rated at 625 CCA/180 RC for most heavy-duty starting requirements.

DR31-750 — Rated at 750 CCA/160 RC for medium-duty applications that may have limited mounting areas or limited cycling and starting power requirements.

DR31-900 — Rated at 900 CCA/160 RC for extreme cold climates or high starting power requirements with limited mounting space.



DEEP CYCLE BATTERY

Designed for severe cycling applications.

DR31-650DCS — Rated 650 CCA/165 RC, this battery is perfect for car carriers, RVs, refrigerated trailers, commercial-marine, coaches and school buses.

Road Gang® Battery Features and Benefits (Group 31 12V)

Features	Benefits
Factory-sealed maintenance-free	Battery never needs water or service
Wrought lead-calcium grid design	Lower electrolyte loss ensuring long life
No antimony in plates	Resists overcharge, heat & thermal runaway. Reduces self discharge and permits storage for 1 year or more
Built-in hydrometer	Instant state-of-charge indicator
Flat-top design	Improved mounting flexibility
Center cast-on plate straps	Excellent vibration resistance
Hot melt anchored on top of elements	
Envelope separators encapsulating the plates	Prevents "treeing" and internal shorting
Exclusive liquid gas separator	Prevents electrolyte loss by collecting liquid & returning it to main reservoir
Rugged polypropylene case w/ flex-rib design	Improved vibration characteristics
Built-in flame arrester	Prevents flame entry from outside source

Road Gang® Battery Specifications (Group 31 12V)

Road Gang® Order Part Number	Road Gang® Model Number	CCA	RC	Unlimited Mileage/Free Warranty Replacement Period
19049905	DR31-625T	625	180	24 Months
19049906	DR31-625P	625	180	24 Months
19049942	DR31-650DCS	650	165	12 Months
19049904	DR31-750T	750	160	24 Months
19049939	DR31-750P	750	160	24 Months
19049902	DR31-900T	900	160	24 Months
19049903	DR31-900P	900	160	24 Months
19049940	DR31-2150T*	700	180	24 Months
19049941	DR31-2150P*	700	180	24 Months

* Original equipment replacement battery.

All Road Gang® Heavy-Duty Group 31 Batteries are 12 volt. They all have top retainer mounting and the same physical dimensions: 13.0 in. (330.2mm) L x 6.8 in. (172.00mm) W x 9.5 in. (240.3mm) H. Maximum ambient temperatures are 52 degrees C (125 degrees F) continuous and 75 degrees C (167 degrees F) intermittent.



DELCO REMY CORE POLICIES

With the purchase of any reman exchange unit, the appropriate core eligibility is reflected on your core statement. Credit is on a “like for like” basis and will be issued upon receipt, pending eligibility, for up to 13 months. Cores returned in excess of eligibility will not receive credit and will be recorded in your core bank. This applies to all eligible Delco Remy program cores.

Returned Cores With Eligibility

Example:

- ** Purchase 10 units of 42MT starters, 10 units of 42MT starter eligibility are generated.
- ** Return 10 units of 42MT starters, 10 units of 42MT starters are credited.

Returned Cores Without Eligibility or Excess Cores Will Be Put In The Core Bank

Example:

- ** Purchase 10 units of 42MT starters, 10 units of 42MT starter eligibility are generated.
- ** Return 10 units of 40MT starters, 10 units of 40MT starters are banked.
- ** Return 14 units of 42MT starters, 10 units of 42MT starters are credited and 4 units of 42MT starters are banked.
- ** No core credit will be issued for non-Delco Remy program cores or non-rebuildable cores.

Example:

- ** Exploded armatures
- ** Rusted or junkyard cores
- ** Missing parts or disassembled cores
- ** Non-Delco Remy program cores

Core Return and Freight Policy

- ** **For shipping arrangements:** call Schneider Logistics, Inc. at 1-888-283-1809.
- ** Complete “Bill of Lading” as follows: **Used auto parts, each less than 50 lbs. in package, value of reconditioning only, NMFC It 18630-3.**
- ** For assistance with Delco Remy core returns, call 888-488-0276 or fax inquiries to 601-481-1936.

WARRANTY RETURNS	NON-WARRANTY CORES	ALL 50DN UNITS
Ship Warranty Units to: Remy Reliability Center 118 Old School Drive Raleigh, MS 39153 Phone: (601) 789-5784	Ship Core Only Units to: Remy Reman Core Return Center 715 Front Street Meridian, MS 39301 Phone: 888-488-0276	Ship Warrantys & Cores to: Remy Reman Core Return Center c/o A.D.E. 420 Evans Ave. Reno, NV 89512 Phone: 775-322-2157
Freight under 150 pounds: Ship UPS Ground using account no. 355-924 Freight over 150 pounds: Call Schneider Logistics, Inc at 1-888-283-1809	Freight Terms: *Collect: 500 lbs or more *Prepaid: 499 lbs or less	Freight Terms: *Collect: 500 lbs or more *Prepaid: 499 lbs or less